



P9000 Data Sheet

Sentro 1 Universal Gas Detector with audio visual alarm

Safety monitoring of toxic and flammable gases, in heavy-duty applications with fully integrated audio visual alarm for wide area working.

Environments: Mining • Tunnelling • Storage Areas • Process Plants • Utilities • Oil & Gas

Features

- High accuracy gas detector with calibrated input sensing modules to detect a range of Toxic and Flammable gases
- Module can be changed out in seconds for easy calibration and maintenance
- Standard 4 to 20 mA analogue output signal
- Large backlit LCD readout provides clear sensor information and diagnostic data
- Auto ZERO and SPAN calibration with simple display instructions
- Integrated high intensity, all-round, audio/visual alarm for wide area working, with periodic flashing confidence alert
- High strength, dual wall moulded housing for maximum impact protection
- Easy access terminal chamber with large, vibration secure, terminals for connecting heavy plant cables
- Dust and waterproof to IP65 with full EMC conformity
- Automatic calculation of STEL and TWA limits
- Certified for use in hazardous areas



Sentro eModule
Pre-calibrated plug-in sensing modules can be changed for rapid calibration and servicing - even with the power applied.

Universal Sensing

The heart of the Sentro 1 is the Sentro eModule - an intelligent standardised gas sensing module that detects a choice of environmental safety conditions. Dynamic data is stored within the eModule, together with the condition of the gas sensing element and its service history.

The modules are already calibrated so they can be substituted at any time with a replacement module. Each eModule retains its calibration data and is automatically recognised by Sentro when the eModule is inserted. This significantly simplifies calibration and maintenance and the module can be changed, even with the power applied. Up to 20 insert codes can be configured when it is necessary to ensure that the same type of Sentro eModule is always used.

High intensity audio visual alarms

Fully integrated wide-area warning alarms can be programmed to trigger at a preset gas concentration level on a RISING or falling alarm mode.





TWA and STEL

Selected toxic gas sensing modules are equipped with automatic Time Weighted Average (TWA) and Short Term Exposure Limit (STEL) calculation, in accordance with COSHH recommendations.



Toxic and Flammable Gas Sensing • Group 1 Underground Mining

A Choice of High Accuracy Sensing Technologies

			Range	TWA/STEL	Type of cell
	Carbon Monoxide	CO	0 to 250 ppm	✓	Electrochemical
	Hydrogen Sulphide	H ₂ S	0 to 50 ppm	✓	Electrochemical
	Oxygen	O ₂	0 to 25% v/v	-	Electrochemical
	Methane	CH ₄	0 to 100% v/v	-	Infrared
	Carbon dioxide	CO ₂	0 to 100% v/v	-	Infrared

Other gases and ranges are available. Please contact Trolex for further information.

Auto Ranging Infrared Technology

Methane sensors operating over the 0 to 100% v/v range are also required to accurately monitor low level, dangerous gas concentration, in the important LEL range. Sentro eModules are equipped with automatic range-changing giving high resolution in the critical LEL zone for precision, measurement, and full-scale ranging for a meaningful readout in the 100% v/v sector.

The internal processor constantly monitors the rise and fall of the gas signal and seamlessly transposes the response to the optimum scale range to maximise the accuracy of the infrared sensor.

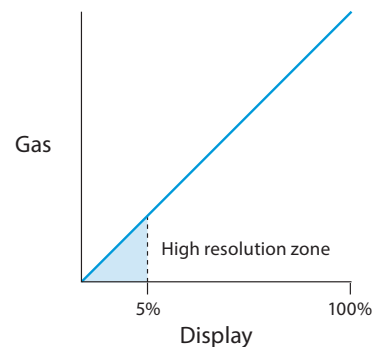



P9000 Data Sheet

Technical Data

Operating temperature range:	-20 to +40°C
Humidity:	90% RH, non-condensing
Storage temperature limits:	-20 to +60°C
Housing materials:	Reinforced polymer EMC protected and proof against surface electrostatic charge
Protection classification:	Dust and waterproof to IP65. Gas port: IP54
Weight:	650 g
Mounting:	Two 6.5 mm diameter fixing holes (Unistrut 6946 compatible)
Light source:	High intensity LEDs
Audible alarm:	High intensity audible sounder 85 dB @ 1 m (12 V dc)
Alarm indication:	Flashing visual alert every 1 second Optional audible alarm Optional confidence alert at 15 second intervals
Alarm signal out of limits:	Alternating LED flash with double sounder 'beep' – when fitted
Alarm setpoint:	0 to 100% of full scale.
Alarm setpoint mode:	RISING/FALLING input signal
Alarm default settings:	P9000.250.250.01 CO : 30ppm. RISING signal P9000.251.01 H ₂ S : 10ppm. RISING signal P9000.257.01 O ₂ : 19.5%v/v. RISING signal P9000.242.01 CH ₄ : 20% LEL. RISING signal P9000.279.01 CO ₂ : User defined. RISING signal
Hysteresis:	5% of setpoint

Electrical Information

Output signal:	4 to 20 mA
Supply voltage:	7.5 to 16.5 V dc
Supply current:	P9000.250.250.01 60 mA Mean 120 mA peak during flash P9000.251.01 60 mA Mean 120 mA peak during flash P9000.257.01 60 mA Mean 120 mA peak during flash P9000.242.01 100 mA Mean 160 mA peak during flash P9000.279.01 100 mA Mean 160 mA peak during flash
Line impedance:	220R Maximum at 12 V dc



Dimensions

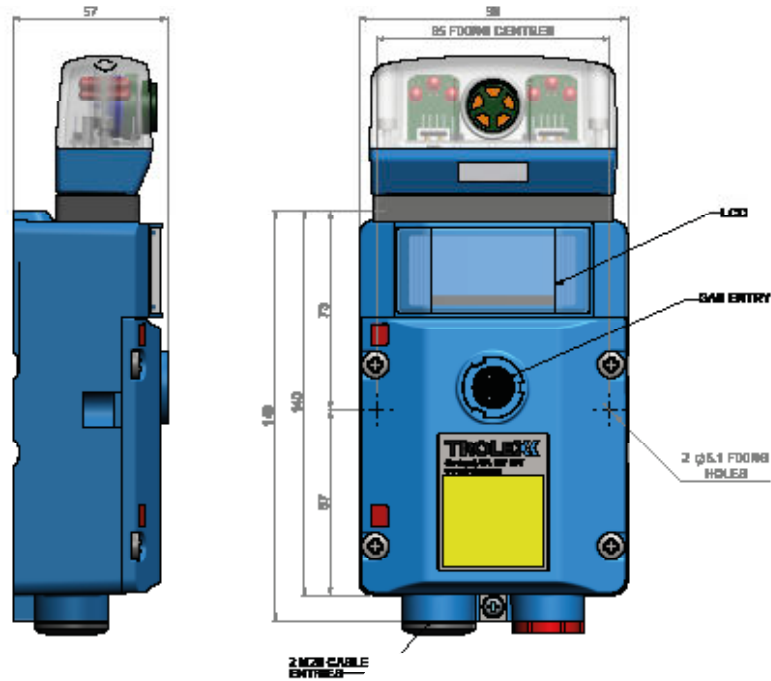

Order Reference

Sentro 1 Universal Gas Detector

	Output signal	Sensing range
P9000.250.250.01	4 to 20 mA	CO 0 to 250 ppm
P9000.251.01	4 to 20 mA	H ₂ S 0 to 50 ppm
P9000.257.01	4 to 20 mA	O ₂ 0 to 25% v/v
P9000.242.01	4 to 20 mA	CH ₄ 0 to 100% v/v
P9000.279.01	4 to 20 mA	CO ₂ 0 to 100% v/v

Alternate configurations can be supplied to specific user requirements.

Please specify non-standard audio/visual alarm setpoint characteristics.

Connections

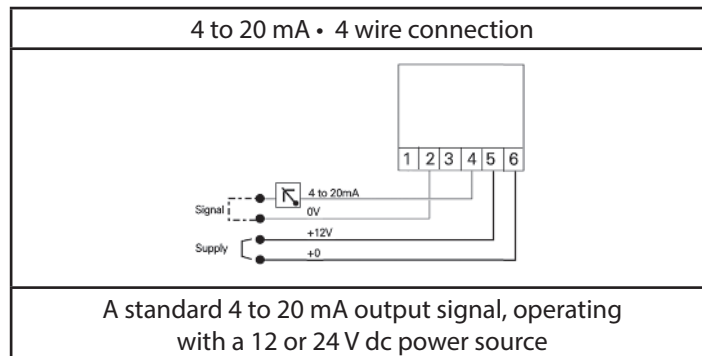



P9000 Data Sheet

Certification

P9000 System consists of two separately certified products:

- TX635x.01i Sentro 1 Gas Detector
- TX6831 Audio/Visual Alarm

ATEX certification for use in underground mines in European Union.
Complies with ATEX Directive 2014/34/EU



Equipment / Product Code	Ex Certificate Number	Ex Certificate Code
TX635x.01i Sentro 1 Gas Detector	Sira 09ATEX2352X	I M1 Ex ia I Ma
TX6831 Audio/Visual Alarm	Sira 99ATEX2152X	I M1 Ex ia I Ma

IECEX (International) certification for use in underground mines



Equipment / Product Code	Ex Certificate Number	Ex Certificate Code
TX635x.01i Sentro 1 Gas Detector	IECEX SIR 09.0147X	Ex ia I Ma
TX6831 Audio/Visual Alarm	-	-

IECEX and ANZEx certification for use in underground mines in Australia (including Queensland) and New Zealand.



Equipment / Product Code	Ex Certificate Number	Ex Certificate Code
TX635x.01i Sentro 1 Gas Detector	IECEX ITA 14.0006X	Ex ia I Ma
TX6831 Audio/Visual Alarm	ANZEx 12.3005X	Ex ia I

EAC certification for use in underground mines in Eurasian Customs Union (including Russia).



Equipment / Product Code	Ex Certificate Number	Ex Certificate Code
TX635x.01i Sentro 1 Gas Detector	RU C-GB.AA87.B.00158/19	PO Ex ia I Ma X
TX6831 Audio/Visual Alarm	RU C-GB.AA87.B.00048/18	PO Ex ia I Ma X

Trox Limited

Newby Road, Hazel Grove, Stockport, Cheshire SK7 5DY, United Kingdom
+44 (0)161 483 1435 sales@trolex.com www.trolex.com

TROLEX



P9000 Data Sheet

MASC (IA) certification for use in underground mines in South Africa.



Equipment / Product Code	Ex Certificate Number	Ex Certificate Code
TX635x.01i Sentro 1 Gas Detector	MASC M/11-419X	Ex ia I Ma
TX6831 Audio/Visual Alarm	MASC M/11-222X	I M1 Ex ia I Ma

DGMS Approval and CIMFR/ERTL Test Reports to support DGMS application for use in underground mines in India.



Equipment / Product Code	Ex Certificate Number	Ex Certificate Code
TX635x.01i Sentro 1 Gas Detector	DGMS Approval No. 722	Ex ia I Ma
	CIMFR Test Report CIMFR/TC/P/H738	Ex ia I Ma
TX6831 Audio/Visual Alarm	ERTL Test Report ERTL(E)/TES/T238/0064/11-12	Ex ia I

Copyright and Trademarks

© 2020 Trolex® Limited.

Trolex is a registered trademark of Trolex Limited. The use of all trademarks in this document is acknowledged.

Document history: Issue 06 1 July 2014 Sixth publication of this document
 Issue 07 15 June 2015 Seventh publication of this document
 Rev A 22 September 2020 Eighth publication of this document