



Serial to Wi-Fi/Ethernet Interface
TX2124



TROLEX <<

User Manual

DECLARATION OF CONFORMITY

A printed version of the Declaration of Conformity has been provided separately within the original shipment of goods.

TX2124 Serial to Wi-Fi/Ethernet Interface

Contents

1.	Introduction	5
2.	Features	5
3.	Connections	6
3.1	Data	6
3.2	Power	7
4.	Installation	8
4.1	Special Conditions for Safe Use (Conditions of Certification)	9
5.	Connecting the TX2124 to a PC/network	11
5.1	Connecting with LAN	11
6	Configuring Wi-Fi network settings	13
7	Setting up the TX2124 Comms Ports	15
7.1	LED Indication	17
8	Mechanical details	18
9	Environmental	18
10	Waste removal information	18
11	Conformity	18
12	Maintenance	18
13	Certification	19
13.1	Marking details	19
14	Ordering information	19



*Antenna not supplied

1. Introduction

The TX2124 is an Intrinsically Safe (IS) Serial to WiFi/Ethernet interface module suitable for Zone 0 mounting with a suitable Ex ia Power Supply.

The Module allows existing Intrinsically Safe equipment with an RS485/RS422 or RS232/TTL port to become Ethernet Enabled via either Wi-Fi (WLAN) or a Cat5/6 cable connection into an IS Ethernet Network (LAN). The unit has 4 serial ports, each one supporting either RS485/RS422 or RS232/TTL depending upon the configuration required. There are 2 RJ45 (LAN) ports that support 10/100 IS Ethernet connections - these allow 'daisy-chaining' of units together.

Power (12V DC) is supplied to the module either locally or using Power over Ethernet (PoEx) from the LAN port - This requires the PoEx output to be wired to the Supply Input terminals by the user.

The compact and cost effective design makes it the ideal choice for many applications such as underground mining, tunnelling, oil and gas & other heavy industry.

Electrical connections are made via cage-clamp plug/socket terminals along with a dual RJ45 type connector for the Ethernet LAN ports. Twin SMA Style RF connectors allow one or two antenna to be connected as required, such as the TX2125 Stud Antenna with cable.

2. Features

- ATEX/ IECEx Certification- Intrinsically Safe
- 4 Communication Ports - RS232/485/422 (2 & 4 Wire)
- Serial Modbus Protocol
- Wi-Fi supporting 802.11 a/b/g/n standards (2.4 & 5 GHz)
- Dual Port Switch 10/100Mb LAN (daisy-chain capability)
- LAN or Wi-Fi to Serial comms
- Wi-Fi, Bluetooth & LAN co-existence
- Modbus/TCP <-> Modbus/RTU (or ASCII) Protocol
- Compact design
- Certified for a variety of applications including Mining
- Zone 0 mounting
- Connection into Zone 0 Gas or Zone 20 Dust Hazardous Areas

3. Connections

3.1 Data

Comms Ports 1+2

Pin	Function	Pin	Function
Port 1			
1	Port1 - TX+/A	2	Port1 - TX-/B
3	Port1 - RX+	4	Port1 - RX-
5	Port1 - TXD (RS232)	6	0V
7	Port1 - RXD (RS232)	8	0V
Port 2			
9	Port2 - TX+/A	10	Port2 - TX-/B
11	Port2 - RX+	12	Port2 - RX-
13	Port2 - TXD (RS232)	14	0V
15	Port2 - RXD (RS232)	16	0V

Comms Ports 3+4

Pin	Function	Pin	Function
Port 3			
1	Port3 - TX+/A	2	Port3 - TX-/B
3	Port3 - RX+	4	Port3 - RX-
5	Port3 - TXD (RS232)	6	0V
7	Port3 - RXD (RS232)	8	0V
Port 4			
9	Port4 - TX+/A	10	Port4 - TX-/B
11	Port4 - RX+	12	Port4 - RX-
13	Port4 - TXD (RS232)	14	0V
15	Port4 - RXD (RS232)	16	0V

LAN Port 1

Pin	Function
1	Tx +
2	Tx -
3	Rx +
4	Spare
5	Spare
6	Rx -
7	Spare
8	Spare

Pin	Function
1	Tx +
2	Tx -
3	Rx +
4	PoEx + 12V*
5	PoEx + 12V*
6	Rx -
7	PoEx 0V*
8	PoEx 0V*

Wifi Antenna Connectors (SMA)

SMA Connector	Antenna
Front	Main (2.4 + 5GHz)
Rear	MIMO (2.4GHz)

3.2 Power

Pin	Function
1	PoEx + 12V
2	NC
3	PoEx 0V
4	Power +12V
5	NC
6	Power 0V

*PoEx (Pins 1+3) must be linked back into the Power connections (Pins 4+6) if used.

4. Installation

This Equipment must be installed, operated and maintained only by trained competent personnel and in accordance with all appropriate international, national and local standard codes of practice and site regulation for intrinsically safe apparatus and in accordance with the instructions contained here.

The TX2124 range is designed in accordance with general electrical safety standards e.g. IEC 60950 or similar.

The equipment should not be used in the vicinity of chemicals which are known to damage plastics unless protected by an additional suitable enclosure.

The connected power supply must be Intrinsically Safe, having a $U_o=14.4V$ or less and suitable for the intended gas or dust group.

The nominal power requirements are 12V @ 150mA.

- Example wiring information for typical field devices is shown in the following diagram (also reproduced on the units side label)

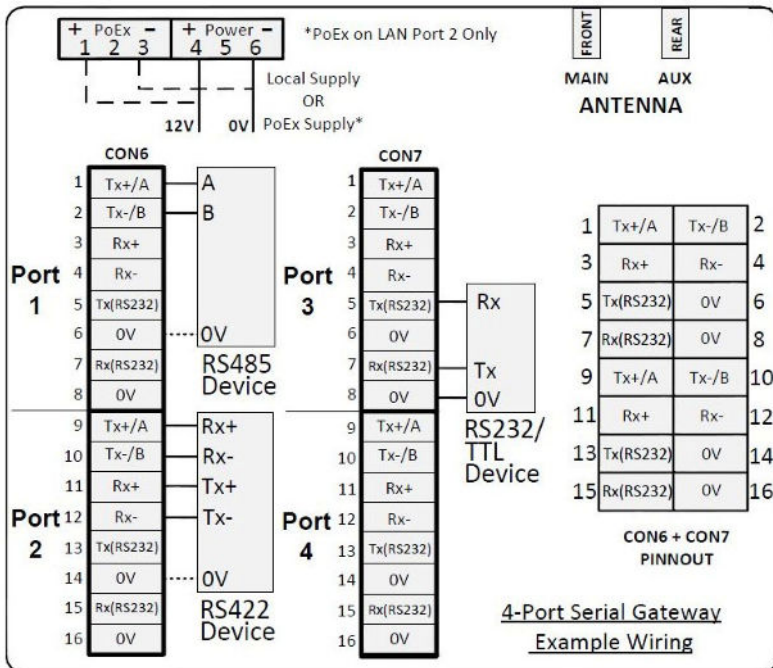

4.1 Special conditions for safe use (Conditions of certification)

The following conditions relate to safe installation and/or use of the equipment, this is an extract from the certificate CML 16ATEX2132X.

- 14.1 When used with Group I gases and Group III dust, the modules shall each be mounted within an enclosure providing a degree of protection of at least IP54. This shall be in accordance with EN 60529, and the mounting arrangement shall not impair the existing creepage and clearance distances. The enclosure shall also comply with the appropriate requirements of Clauses 7 and 8 of EN 60079-0.
- 14.2 The RJ45 connectors do not meet the ingress protection rating of IP20, when they are not fitted with either a connector or blanking plug. For Group II, the RJ45 connectors must be fitted with either a plug or blanking plug or the module shall be mounted in an enclosure meeting IP20.
- 14.3 When used in Group II, under certain extreme circumstances, the non-metallic parts incorporated in the enclosure of this equipment may generate an ignition-capable level of electrostatic charge. Therefore, the equipment shall not be installed in a location where the external conditions are conducive to the build-up of electrostatic charge on such surfaces. In addition, the equipment shall only be cleaned with a damp cloth.
- 14.4 The supply to the modules must be derived from a suitably certified, intrinsically safe supply having a $U_o=14.4V$ or less and suitable for the intended gas or dust group.
- 14.5 In the case of any connection to the RS232/TTL circuits, if the transmit 'TX' line within both the cable and the other certified equipment can be shown to be suitably segregated from the receive line, 'RX', then U_i can be specified as 12.5V. If the segregation cannot be proved, then U_i for both TX and RX must be specified as 5.88 V (Note: Suitable segregation for up to 30V as specified in Table 5 EN 60079-11 is a minimum of 2mm creepage and clearance, 0.7mm through casting compound or under coating, or 0.5mm solid insulation with $CTI \geq 100$).
- 14.6 The values of C_o and L_o shall apply when one of the two conditions below is given:
 - The total L_i of the external circuit (excluding the cable) is $< 1\%$ of the L_o value, or,
 - The total C_i of the external circuit (excluding the cable) is $< 1\%$ of the C_o value. The above parameters are reduced to 50% when both of the two conditions below are given:

- The total Li of the external circuit (excluding the cable) > 1% of the Lo, and
- The total Ci of the external circuit (excluding the cable) > 1% of the Co.

Note

The reduced capacitance of the external circuit (including cable) shall not be greater than 1 μ F for IIB and 600 nF for IIC.

- 14.7 The equipment shall be capable of withstanding an electric strength test using a test voltage of 500 Vac applied between the circuit and earth for 60 sec. Alternatively, a voltage of 20% higher may be applied for 1 s. There shall be no evidence of flashover or breakdown and the maximum current flowing shall not exceed 5 mA.

5. Connecting the TX2124 to a PC/network

5.1 Connecting with LAN

- Ensure that the TX2124 unit is powered by a suitable IS supply. PoEx can be used to power the unit via LAN port 2 if required.
- The TX2124 should then be connected to an IS Ethernet Network/PC using a suitable CAT5/6 cable. Either LAN Port 1 or 2 can be used. The other LAN port can be used for daisy chaining units together. PoEx only available on port 2.
- Run the Trolex TX2124 Locator program which can be found on the Trolex website under 'Resources'. Once downloaded, this will automatically search for and locate any TX2124 units connected to the network.

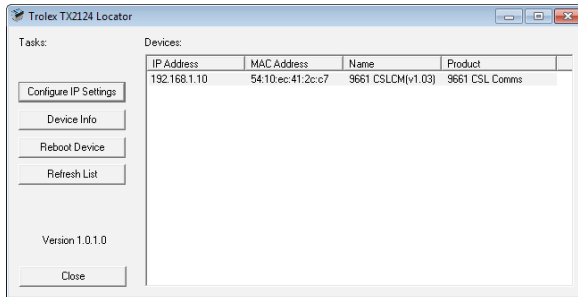

- Click on the device that you are looking to configure, then click the “configure IP settings” button and this will bring up the following screen.

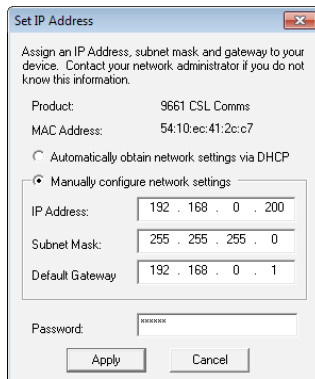

- Manually type in the settings that you require and then enter the password “Tr01ex. Click the apply button to send the settings to the TX2124.
- Reboot the device by either powering down or by clicking the “reboot” button in the above screen.
- Once the TX2124 is up and running, navigate to the IP Address that has been programmed into the unit using a web browser and you will see the following screen.

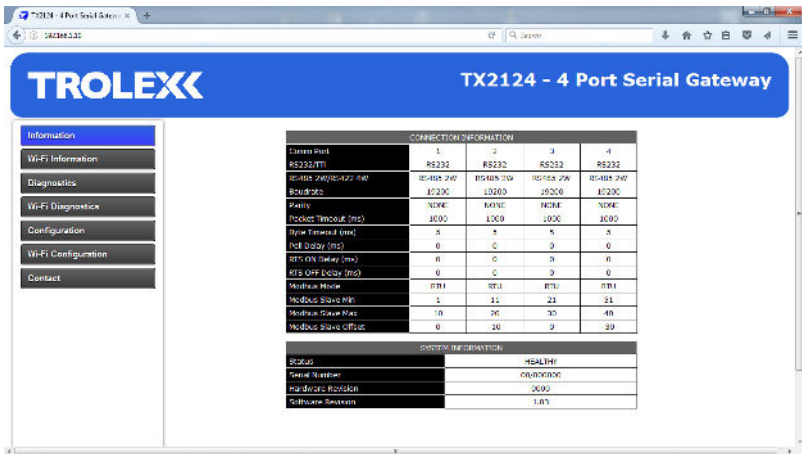

- This page shows the current configuration of the 4 Comms ports.

6 Configuring Wi-Fi network settings

- Click on the Wi-Fi Information menu option and you will see the screen below

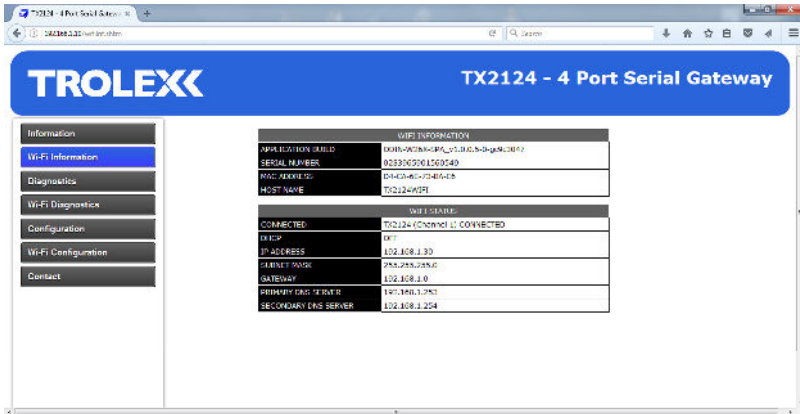

This shows information about the Wi-Fi module and the current settings associated with it, including whether there is an active Wi-Fi connection.

To change any of the settings this is done in the following step

- Click on the Wi-Fi Configuration menu option, this prompts the user to enter a username and password. The defaults are shown below, both are case sensitive –
 Username: admin
 Password: Tr01ex

You will then see the following screen

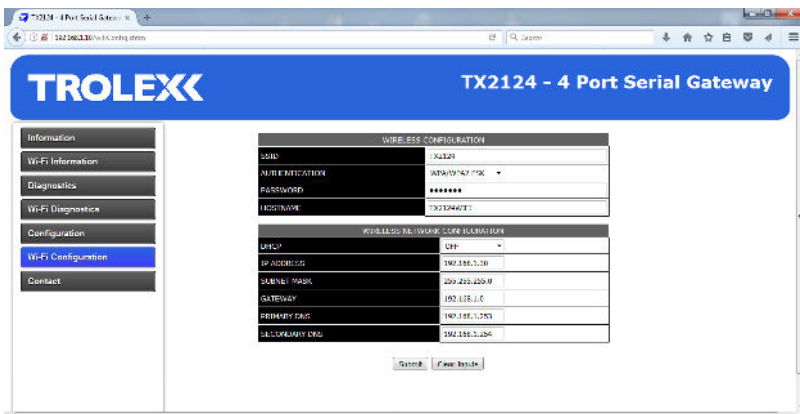

- **SSID** – This should be configured to the same **SSID** as your access point / router you want the unit to connect to.
- **Authentication** – This enables **WPA/WPA2-PSK** security on the Wi-Fi link and is the recommended setting. The only other option is **Open** where no security is used.
- **Password** – This must match the password set on the access point / router you are trying to connect to
- **Hostname** – You can type any name you chose to help identify this device on your network
- There is also the option to use **DHCP** or use **fixed IP** address as required
- Click on the Wi-Fi Diagnostics menu option and you will see the screen below

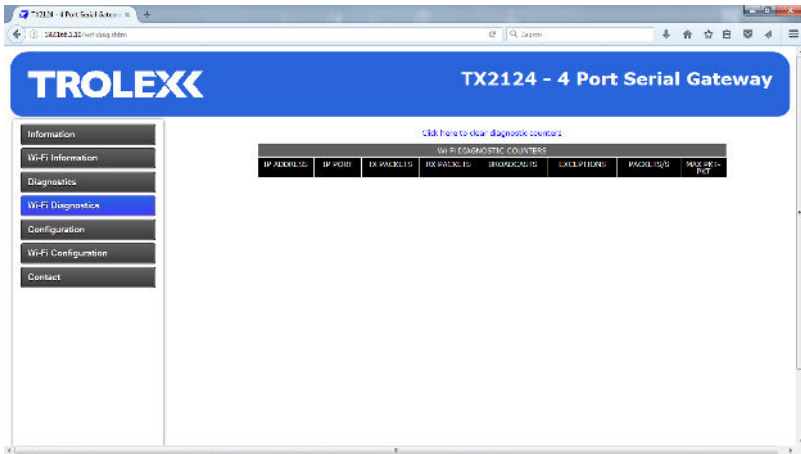

- This page is similar to the Diagnostics page which shows information regarding the LAN and Serial Ports in that it provides information on the Wi-Fi connected Modbus/TCP clients and can be useful for fault finding.

7. Setting up the TX2124 Comms Ports

To change any of the settings this is done in the following step

- Click on the Wi-Fi Configuration menu option, this prompts the user to enter a username and password. The defaults are shown below, both are case sensitive –
 Username: admin
 Password: Tr01ex

You will then see the following screen

- Click on the configuration menu option and you will see the screen below

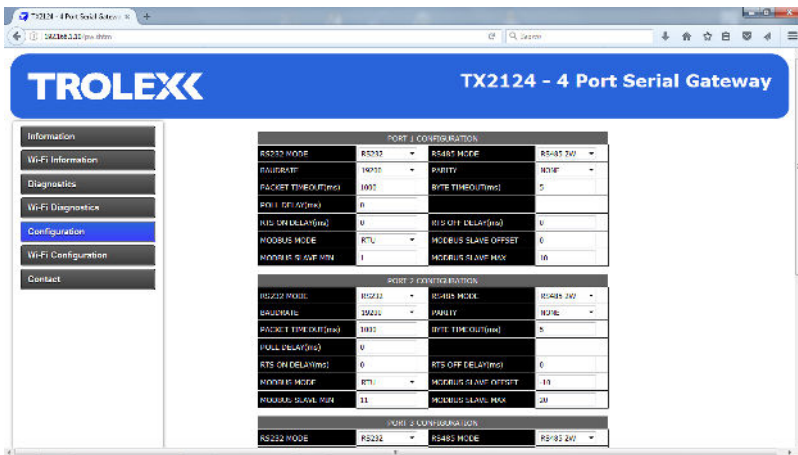

- Using this page you can modify the current settings on each of the 4 Comms ports and set them up accordingly.
- The Slave offset allows the user the option of having the same serial slave addressed devices on the 4 ports. It uses the sign and offset value to alter the slave address received on the Ethernet before it is passed to the serial port. In the above screen, the following configuration is used;

Port	TCP Slave Address	Offset	Serial Slave Address
1	1-10	+0	1-10
2	11-20	-10	1-10
3	21-30	-20	1-10
4	31-40	-30	1-10

- The Modbus slave Min and Max sets the TCP slave address limits for that port.
- Packet Timeout sets the maximum time waiting for the first byte of a reply from a slave. (100ms is typical but may be extended for “slow” slaves or reduced for “fast” ones)
- Byte Timeout determines the end of a slaves reply as when another byte is not received during this time. (typically set between 2ms and 20ms depending upon Baudrate)
- Poll Delay slows down the packet rate if required. (Default is 0ms)
- RTS ON Delay gives a delay after RTS before the packet data is sent, RTS OFF gives a delay after the packet data is sent before releasing RTS signal (typically 0ms to 5ms)
- Once the settings have been configured click the submit button.
- Configuration message will be displayed for 3 seconds before returning back to the main page.
- Click on the Diagnostics page option and it will display the following screen.

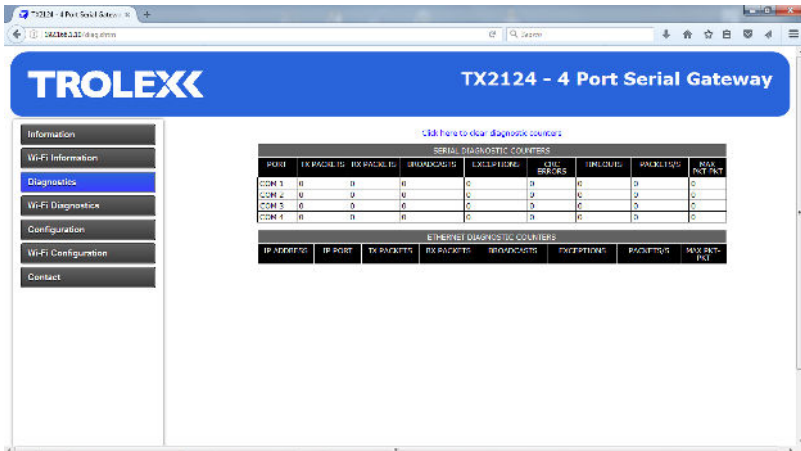

- This page shows the counters for all of the LAN connected Modbus/TCP clients as well as the serial ports, this can be useful for fault finding.

7.1 LED Indication

- The Following table shows the status of the LED's on the front of the TX2124 Module.

Port	OFF	FLASH	ON
PWR (green)	Power Fail	N/A	Power OK
WDG (red/green)	Fault	Green - Healthy (10Hz)	Fault
WLAN (red/blue)	Idle	Red (config mode) Blue (data)	Red (fault) Blue (connected) Purple (connecting)
TX (green)	Idle	Transmitting Serial Data	N/A
RX (red)	Idle	Receiving Serial Data	Fault – RX data polarity is inverted
STAT (red/green)	N/A	Green – Identify module mode	Red (fault) Green (healthy)
RJ45 ACT (yellow)	Ethernet link disconnected	Ethernet link activity	Ethernet link connected
RJ45 100 (green)	10Mbps	N/A	100Mbps

7.2 Factory Reset

To reset the TX2124 to factory defaults, follow this sequence:

- Power on the unit and in less than 3 second press the reset switch – the green status LED will go red and the green watchdog (heartbeat) LED will still keep flashing (100Hz). This has factory default the unit. Cycle the power to reboot to get rid of the red status LED back to green. The LAN IP will now be 192.168.0.200 and other settings reset to factory.
- If the green watchdog (heartbeat) LED turns red and flashes very fast then the button was pressed too quick after power-up and it is now in bootloader mode instead. Cycle the power and try again.
- If the green status LED does not go red then the button was pushed too late (> 3second) after power up. Cycle the power and try again.

8. MECHANICAL DETAILS

Enclosure dimensions

Width	Height	Depth	Weight
45mm	147mm	155mm	357g

All values are approximate

Mounting

- The TX2124 module will clip onto standard DIN Rail (TS35)
- Black plastic clips from the top and bottom of the module can be pulled out to allow it to sit over the DIN Rail, the clips will then be pushed back into place to secure the module.

9. ENVIRONMENTAL

Operating Temperature	-40°C...+70°C
Storage Temperature	-40°C...+70°C
Humidity	0...95% RH, non-condensing
Ingress Protection	Select enclosure to suit application, see certificates for information.

10. WASTE REMOVAL INFORMATION

The Electronic equipment within must not be treated as general waste. By ensuring that this product is disposed of correctly, you will be helping to prevent potentially negative consequences for the environment and human health, which could otherwise be caused by incorrect waste handling of this product.



For more detailed information about take-back and equipment recycling please contact your local Trolex representative.

11. CONFORMITY

Refer to Declaration of Conformity

12. MAINTENANCE

There is no routine maintenance required

13. CERTIFICATION

I M1 Ex ia I Ma

II 1G Ex ia IIC T4 Ga

II (1D) [Ex ia Da] III CT135°C

CML 16ATEX2132X

IECEX CML 16.0054X

See Certificates for further information

13.1 Marking details

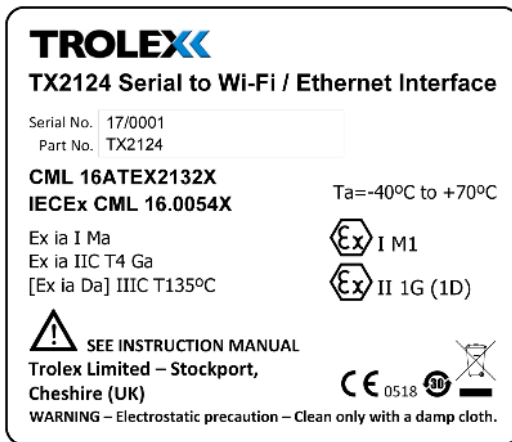

Part No. TX2124 Serial to Wi-Fi/Ethernet Interface

14. ORDERING INFORMATION

TX2124 Serial to WiFi/Ethernet Interface

TX2125.01 Stud Antenna 0.6M cable (2.4 & 5.0 GHz)

TX2125.02 Stud Antenna 1.5M cable (2.4 & 5.0 GHz)

Disclaimers

The information provided in this document contains general descriptions and technical characteristics of the performance of the product. It is not intended as a substitute for and is not to be used for determining suitability or reliability of this product for specific user applications. It is the duty of any user or installer to perform the appropriate and complete risk analysis, evaluation and testing of the products with respect to the relevant specific application or use. Trolex shall not be responsible or liable for misuse of the information contained herein. If you have any suggestions for improvements or amendments, or find errors in this publication, please notify us at: marketing@trolex.com.

No part of this document may be reproduced in any form or by any means, electronic or mechanical, including photocopying, without express written permission of Trolex.

All pertinent state, regional, and local safety regulations must be observed when installing and using this product. For reasons of safety and to help ensure compliance with documented system data, only Trolex or its affiliates should perform repairs to components.

When devices are used for applications with technical safety requirements, the relevant instructions must be followed.

Trademarks

© 2017 Trolex® Limited.

Trolex is a registered trademark of Trolex Limited. The use of all trademarks in this document is acknowledged.

Document History

P5629.1600 Rev A December 2017

Contact Details

Trolex Ltd, Newby Road, Hazel Grove, Stockport, Cheshire, SK7 5DY, UK

+44 (0) 161 483 1435 sales@trolex.com

TROLEX«

Trox Ltd. Newby Road, Hazel Grove, Stockport, Cheshire SK7 5DY, UK
t: +44 (0)161 483 1435 **e:** sales@trolex.com www.trox.com