



TX6355

Sentro Wireless 



TROLEX 

User Manual

TX6355 Sentro Wireless

Contents

1.	Product Overview	4	4.5.4	Module Setup	34
1.1	Operating Features	4	4.5.5	CommTrac	38
1.2	Application	5	4.5.6	Exit	44
1.3	Product Options	5	4.6	Support	44
1.4	Dimensions	6	5.	Diagnostics and Maintenance	45
1.5	Technical Information	7	5.1	Diagnostic Messages	45
1.6	Electrical Details	8	5.1.2	Sensor Negative Drift	46
1.7	Sentro eModules	9	5.1.3	Recovery from Display Freeze	46
1.7.1	Sentro eModules	9	5.2	Maintenance	47
1.7.2	MSHA Certified eModules	9	5.2.1	Introduction	47
2.	Certification	12	5.2.2	Gas Inlet Port - Check and Clean	48
2.1	United States of America (MSHA)	12	5.2.3	Bump Test	48
2.2	South Africa (MASC)	13	5.2.4	Replacing the Batteries	49
2.3	Australia -IECEX	13	5.2.5	Sentro eModule - Calibrate	49
3.	Installation	15	5.2.6	Safety Check	50
3.1	Safety Precautions	15	5.2.7	Sentro eModule - Replace	50
3.2	Tools and Test Equipment Required	16	5.3	Recommended Test Gas Concentrations	51
3.3	Siting Recommendations	16	5.4	Disposal	52
3.4	Connections	17	5.5	Maintenance Records	52
3.5	Connecting in Hazardous Areas	17	5.6	Maintenance and Calibration Log	53
4.	Setup and Calibration	18	Disclaimers	54	
4.1	Controls and Indicators	18	Trademarks	54	
4.2	Software Menus	20	Document History	54	
4.3	Navigation	21	Contact Details	55	
4.4	Power-up	22			
4.5	Main Menu	23			
4.5.1	Calibrate	24			
4.5.2	TX6355 Setup	27			
4.5.3	Modbus Address	32			

1. Product Overview

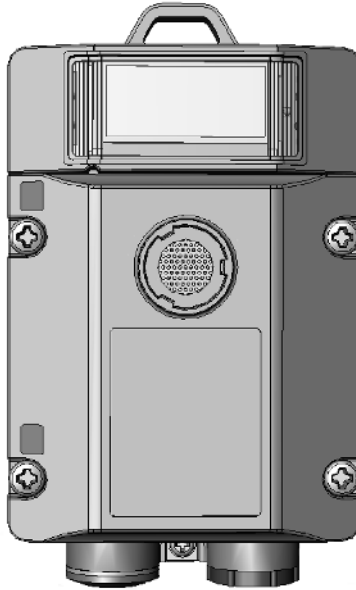

TX6355	Digital wireless output signal Can be used with any Sentro eModule Built in battery pack
--------	--

1.1 Operating Features

- Fixed sensor for the detection of toxic gases and flammable gases
- Exclusive pre-calibrated plug-in gas sensing modules for many types of gas and climatic conditions
- LCD readout and visual LED alarm indicators
- Strata specific digital wireless output signal
- Battery powered operation from built in battery pack
- Heavy duty housing to IP65, EMC compliant
- Simple, easy to use menu structure
- Easy integration into legacy wireless networks

1.2 Application

Fixed point gas detection for safety monitoring in hazardous areas and general purpose applications.

Underground Mining and Tunnelling Ex ia	Supply Voltage: 6 V dc from built in battery pack
TX6355	Type of protection: Intrinsically safe. Ex ia

1.3 Product Options

	Supply Voltage:
TX6355.03	General Purpose - 6 V dc from built in battery pack
TX6355.04.01	MSHA Approved - 6 V dc from built in battery pack
TX6355.04.02	MSHA Approved and QPS Performance Approved- 6 V dc from built in battery pack
TX6355.05	MASC Approved - 6 V dc from built in battery pack
TX6355.06	Australia certified - 6 V dc from built in battery pack

A choice of Sentro eModules for sensing a range of toxic and flammable gases. See pages 9 to 14 for details of compatible Sentro eModules.

1.4 Dimensions

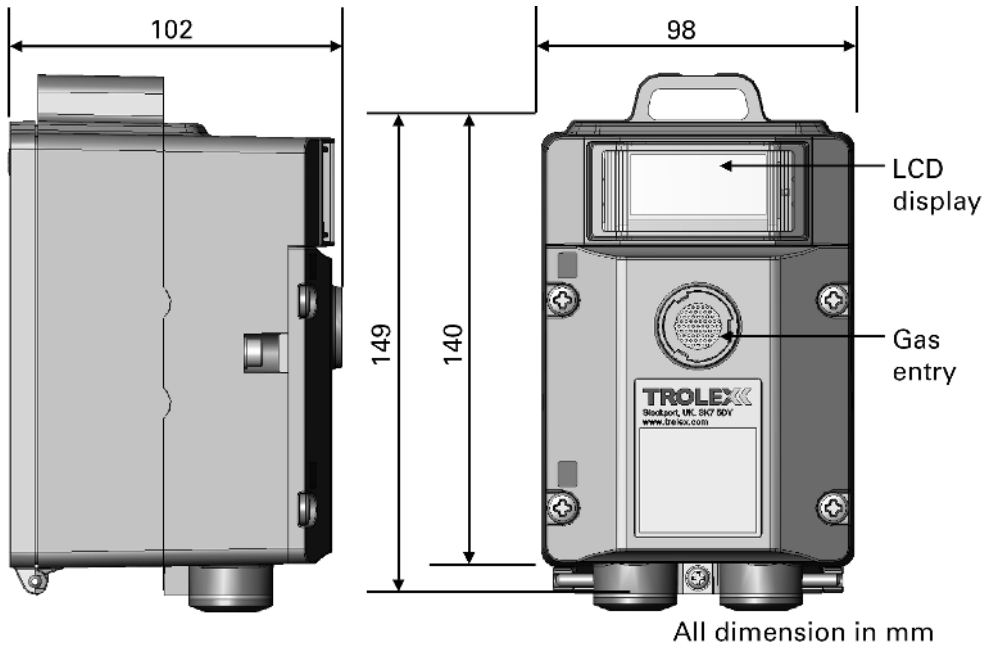

1.5 Technical Information

Ambient temperature limits	-20 °C to +40 °C
Storage temperature	-20 °C to +60 °C
Ambient pressure	800 to 1100 mbar
Humidity	90% non-condensing
Protection classification	Dust and waterproof to IP65. Gas Port: IP54.
Housing material	Reinforced polymer
Nett weight	1400 g
Cable entries	None
Information display	128 x 64 dot graphic backlit LCD
Vibration limits	Vibration limits (EN 60079-29-1): <ul style="list-style-type: none"> • 10 to 30 Hz - 1.00 mm total excursion • 31 to 150 Hz - 19.6 m/s² acceleration peak
Impact limits	20 joules (housing)
Calibration and setup	Digitally controlled ZERO and SPAN pushbutton setting
Signal fix	The analogue output signal of the sensor is fixed during calibration to prevent false alarms from being initiated
Fault indication	Under range signal transmitted and fault display for: <ul style="list-style-type: none"> • Loss of communications from the sensing module • Sensing module absent for more than 10 seconds • Negative drift below zero, 10% full scale • Sensor over-range protect
Key coding	Coding stops prevent insertion of a non-valid sensing module.
Alarms	Programmable General alarms and High alarms with an LED indicator. The two adjustable alarm setpoints are preset during manufacture to default values appropriate to the type of sensor, determined by the sensing module being used.

Output signals	Strata specific digital wireless output signal
Supply voltage	6 V dc from internal battery pack
Current consumption	40 to 45 days life from internal batteries when suitable eModules fitted. (see section 1.7.2)
Mounting	By attachment point on the top of the Sentro Wireless housing - will accept a standard 25 mm strap

1.6 Electrical Details

Description	
Supply voltage	6 V dc (+/- 5%)
Supply current	200 mA (maximum loading including one pellistor eModule)
Output relays	None

1.7 Sentro eModules

Plug-in pre-calibrated eModules with standardised output data.

- Each eModule stores all the necessary data about its type identification, sensing range and specific calibration. This data is automatically recognised by Sentro when the eModule is loaded into the module bay
- The eModules are pre-calibrated so they can be replaced at any time with a replacement sensing module - usually of the same type, but an alternative may be inserted if required
- User configurable coding slots at each module bay can be individually configured using coding stops to prevent invalid sensing module combinations
- The eModule will identify itself when plugged into the sensor housing and auto configuration will take place
- All Sentro eModules have two output alarm signals for General alarm and High alarm. Default values are entered during manufacture and these can be changed to preferred values
- The alarm signals can be set to illuminate built-in flashing LED indicators



eModule Gas Sensor

1.7.1 Sentro eModules

For information and advice on the full range of Sentro eModules contact the Trolex Sales Team: sales@trolex.com

1.7.2 MSHA Certified eModules

Sentro Wireless TX6355 is certified by MSHA for use with the following eModules:

 **Module List**

2 of 2

TX6350.04.249	Methane CH ₄	0 to 100% LEL (5%)	Infrared. See note 1.
TX6350.04.297	Methane CH ₄	0 to 4%/v/v	LED infrared
TX6350.04.248	Methane CH ₄	0 to 5%/v/v	LED infrared
TX6350.04.296	Methane CH ₄	0 to 100% v/v	LED infrared
TX6350.04.298	Methane CH ₄	0 to 100% LEL (4.4%)	LED infrared
TX6350.04.299	Methane CH ₄	0 to 100% LEL (5%)	LED infrared
TX6350.04.278	Carbon Dioxide CO ₂	0 to 5%/v/v	Infrared. See note 1.
TX6350.04.279	Carbon Dioxide CO ₂	0 to 100% v/v	Infrared. See note 1.
TX6350.04.301	Carbon Dioxide CO ₂	0 to 5%/v/v	LED infrared
TX6350.04.302	Carbon Dioxide CO ₂	0 to 100% v/v	LED infrared

Note 1: Not suitable for battery powered version of the Sentro Wireless (short battery life).

**Do Not Change Without
Approval Of MSHA**

Any changes in intrinsically
safe circuits or components
may result in an unsafe condition

Issue	A	B	C							TX6355 Sentro Wireless Gas Sensor
ECR	---		4321							Document No: P5536.285
App'd	LP	AH	AH							
Date	13/01/15	30/10/15	04/04/16							Dirn FT 13/01/15 Cn'd FT 13/01/15



Trox Ltd, Newby Road, Hazel Grove, Stockport, Cheshire, SK7 5DY, UK.
t:+44(0)161 483 1435 e: sales@trolex.com w: www.trolex.com | www.methanemonitoring.net



2. Certification

2.1 United States of America



2.1.1 MSHA Approval

Meets the applicable requirements of Title 30 Code of Federal Regulations, Part 18 (30 CFR Part 18). Approval No. 18-A150002-0. For conditions of use refer to the MSHA controlled drawing no. P5596.1800.

2.1.2 Pennsylvania Approval

Pennsylvania Approval no. BFE 43-15 has been assigned to the equipment. Pennsylvania State has determined that the minimum safe blasting distance is 16.7 feet.

2.1.3 Gas Performance Approval

QPS certification covers the following:

- Sentro Wireless fixed point CO gas detector, model no. TX6355.04.02, when fitted with a CO sensing eModule with part no. TX6350.04.250.50 (0 to 50 ppm range) or eModule part no. TX6350.04.250.500 (0 to 500 ppm range).
- Powered by 4 Energizer E95 D-cell type batteries.
- Indoor use and CO gas only.
- Ambient temperature range of -20°C to +40°C

Note: Only the display and local alarm indications were assessed during the performance verification. The wireless output function was not assessed during the performance verification but may be used for data collection and record keeping functions or other non-safety related functions.

Applicable Standards

- ANSI/ISA-92.00.01-2010 "Performance Requirements for Toxic Gas Detectors, Approved 13 January 2011"
- UL 61010-1 "UL Standards for Safety Electrical Equipment for Measurement, Control, and Laboratory Use; Part 1: General Requirements – Third Edition; Reprint with revisions through and including July 15, 2015".



This warning symbol on the equipment’s marking plate, Represents, “Attention – consult accompanying documents”:

Refer to Section 1.7.2 for the list of approved eModules for Sentro Wireless.



2.2 South Africa (MASC)

Ex certificate number: MASC M/15-0133X Ex certification code:
Ex ia I

Special Conditions of Safe Use (X)

1. May only be used with Energizer EN95/E95 D-type batteries.
2. Outputs #1 and #2 (P5596.01-M sheet 3 of 4) on the Sentro Wireless configuration must be evaluated for intrinsic safety in its final configuration when connected to other devices or equipment.



2.3 Australia IECEx

Model TX6355.06.nn is evaluated against the following standards:

IEC 60079-0:2011 Edition: 6.0

IEC 60079-11:2011 Edition: 6.0

Ex certificate numbers: IECEx TRA 16.0016X Ex certificate code: Ex ia I
Ma

Ingress Protection: IP65 except for gas inlet port (IP54)

Conditions of Use / Warnings:

1. Use only with Energizer E95/EN95 D-type Alkaline Cells. These are wired to screw terminals 4, 5 on J6 Output Board only.
2. The other screw terminals 1, 2, 3, 6 on J6 Output Board shall not be used in the hazardous area.
3. Only Trolex manufactured gas sensing modules (“eModules”) identified by the top level part number “TX6350.06” shall be fitted. The use of these eModules have been assessed for compatibility as part of this certification and are suitable for use in Group I hazardous location.

4. The cover screws must be torqued to a value of 1.24N*m (10in*lbs) following replacement of the eModules (gas sensor) or batteries.
5. Do not open when coal dust is present.
6. Extreme care must be taken to protect the equipment from impact. In the event the unit is dropped or impacted, a competent person must inspect it for any damage that would impair the Ingress Protection (IP54).
7. The batteries must be removed to de-energise the unit before it is transported/relocated.

3. Installation

3.1 Safety Precautions

Hazardous areas

Do not disassemble the sensor whilst in the hazardous area or use a sensor that has a damaged housing in the hazardous area. It is permissible to change the Sentro Wireless batteries whilst in the hazardous area.

Evacuation

If a dangerous level of gas concentration is detected by the instrument, leave the area immediately.

Flammable

Be aware that some toxic gases are also 'flammable' at high percentage concentrations.

Operating Limits of Catalytic Combustion Sensors

Catalytic combustion sensors positively detect the presence of flammable gas. They rely upon the presence of oxygen in the atmosphere and should only be used for gas concentration up to the Lower Explosive Limit (LEL).

After this point, the output becomes non-linear and may erroneously indicate that the gas concentration is below the LEL. They should not be used in oxygen enriched or deficient atmospheres.

Discrimination

Catalytic combustion sensors can detect a wide range of flammable gases but they cannot discriminate between individual gases. They will respond to most, or all, of the flammable components present in the atmosphere without distinguishing between them.

Infrared sensors are highly specific to the defined gas type and may not respond to other similar gases.

Contamination

The response of catalytic combustion gas sensors can be affected by air borne contaminants which will reduce the sensitivity. Substances such as silicones, tetraethyl lead, sulphur compounds and phosphate esters can cause permanent degradation (poisoning). Halogenated hydrocarbons may also cause temporary inhibition.

Interference

If the atmosphere to be monitored contains a gas that dilutes or displaces the air, this may reduce the response of catalytic sensors. Similarly, steam laden atmospheres and condensation can reduce the stability.

High Concentrations of Flammable Gas

Exposure of low concentration catalytic combustion sensors to concentrations of flammable gas greater than the LEL can affect the sensitivity and zero stability of catalytic elements and the calibration should be checked after such an exposure.

Toxicity

Be aware that most flammable gases and vapours are also toxic at low concentrations of LEL.

3.2. Tools and Test Equipment Required

No special tools are needed.

3.3. Siting Recommendations

Location of Gas Detectors

Each installation needs to be considered in its own right, with reference to safety authorities and in compliance with mandatory local safety regulations. The sensor must be operated in accordance with the User Manual to maintain safety, reliability and to preserve safety integrity where applicable.

It is important that sensors are located in positions determined in consultation with those who have specialised knowledge of the plant or installation and of the principles of gas dispersion. Reference should also be made to those responsible for the engineering layout and topology of the plant as they will be most familiar with the nature of the potential dangers and the most likely sources of gas release.

It is also important to recognise that the characteristics of the gas source can be influenced by many factors; including the relative density or buoyancy of the gas, the pressure at the point of release, the ambient temperature and the ventilation of the site.

Sensor coverage cannot be simply expressed in terms of 'number per unit area'. Sensors need to be sited where they are capable of monitoring those parts of a

plant where gas may accumulate or where a source of gas release is expected to occur. This way, the earliest possible warning of a gas release can be given to initiate shutdown functions, alarm functions or safe evacuation of the premises.

Trolex recommends that the Sentro Wireless Gas Detector is positioned a minimum of 6 m (20 ft) and no more than 245 m (800 ft) from a Strata CommTrac C node for the Sentro Wireless Gas Detector to work effectively.

Sensor Management

A very important part of an efficient gas monitoring system is the training of plant personnel in operation and maintenance of the sensors and the complete monitoring system. Training can be provided by qualified Trolex application engineers. Once a sensor installation is complete, the sensor locations and types should be formally recorded and a planned test and maintenance procedure instituted.

STEL and TWA

Selected toxic gas sensors are equipped to automatically calculate STEL and TWA limits in accordance with COSHH standards. If the facility is selected for use, ensure that all accumulated data is reset to zero before the commencement of a working period.

Checkpoint

STEL: Short term exposure limit of total accumulated units over a rolling fifteen minute period. TWA: Time weighted average of gas concentration over a working eight hour period.

3.4 Connections

The Sentro Wireless sensor connects wirelessly to the Strata CommTrac mine wide wireless network. Power is provided by batteries contained within the housing. No hard wiring is required.

3.5 Connecting in Hazardous Areas

Certified Intrinsically Safe for use in underground mine hazardous areas. The installation must be in accordance with the Sentro Wireless certification parameters.

4. Setup and Calibration

4.1 Controls and Indicators

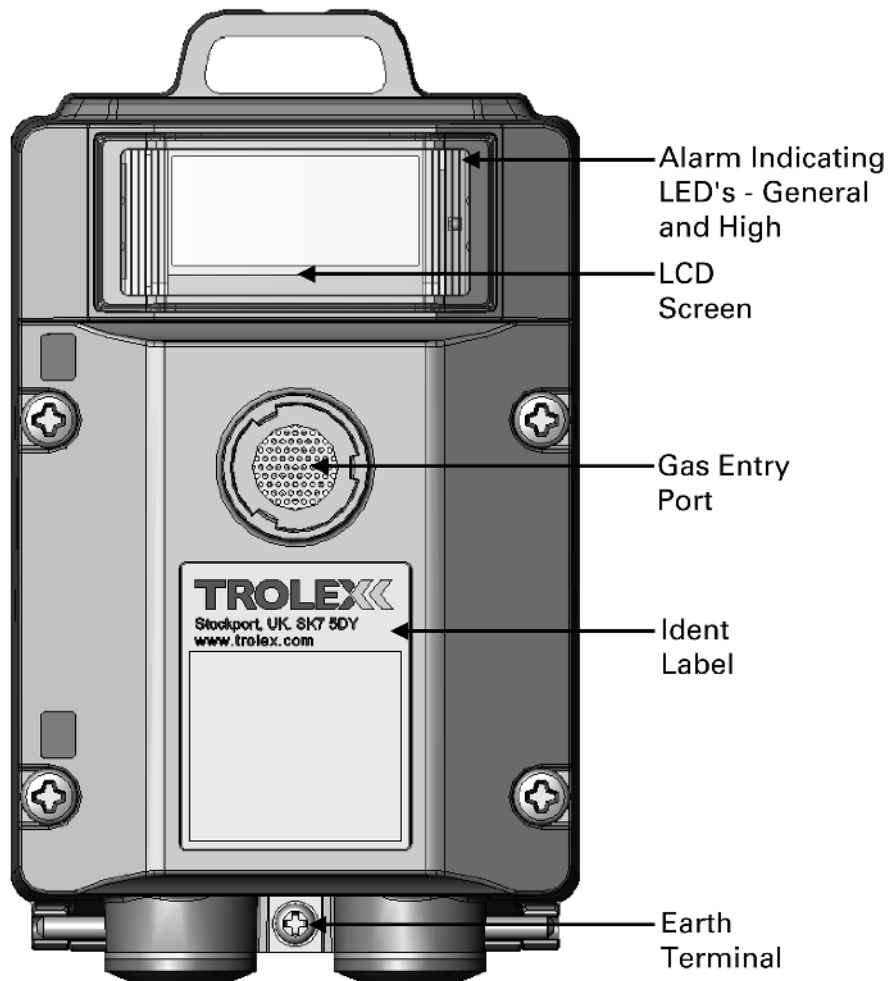

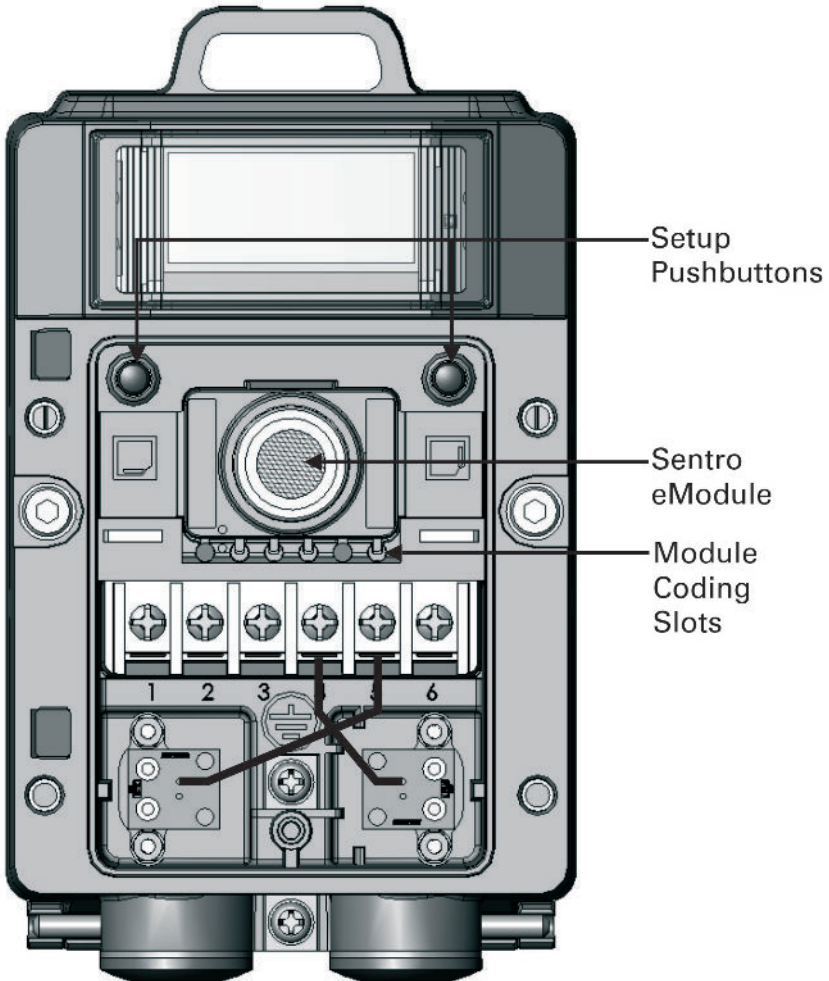

4.2	Software Menus	
4.3	Navigation	21
4.4	Power-up	22
4.5	Main Menu	23
4.5.1	Calibrate	24
4.5.2	TX6355 Setup	27
4.5.3	Modbus Address	32
4.5.4	Module Setup	34
4.5.5	CommTrac	38
4.5.6	Exit	44
4.6	Support	44
5.	Diagnostics and Maintenance	45
5.1	Diagnostic Messages	45
5.1.2	Sensor Negative Drift	46
5.1.3	Recovery from Display Freeze	46

4.3 Navigation



NEXT

SELECT/CHANGE

Checkpoint

To use the Sentro Wireless software and navigate between Function menus you must press the setup keys:

Next is the Left key - L

Select/Change is the Right key - R.

The use of these keys is abbreviated to L and R throughout this User Manual.

To access the L (Next) and R (Select/Change) buttons you need to remove the front cover. Use a cross head screwdriver to remove the four screws securing the front cover and swing it out of the way.

4.4 Power-up

When the Sentro Wireless is powered-up the Start-up Screen will appear. The Start-up Screen displays basic information about the system including the software version, driver version and output type.

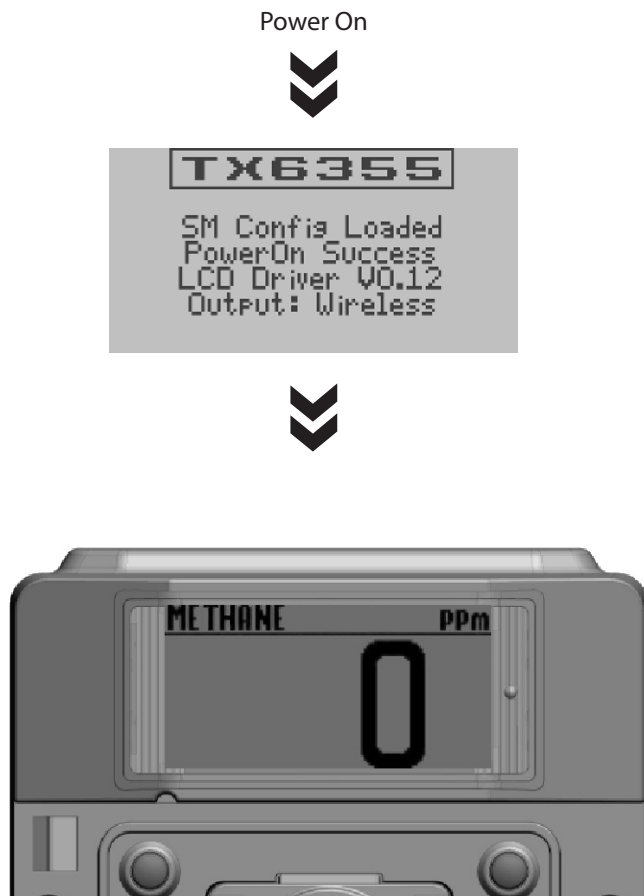

After five seconds the Main Display will appear. The Main Display displays the current gas concentration level and the gas being detected.

4.5 Main Menu

From the Main Display press and hold L, this will bring up the Main Menu.

From the Main Menu the operating parameters of the Sentro and eModule may be set up according to preference. The available menus are as follows:

- Calibrate
- TX6355 Setup
- Output Setup
- Module Setup
- CommTrac
- Exit

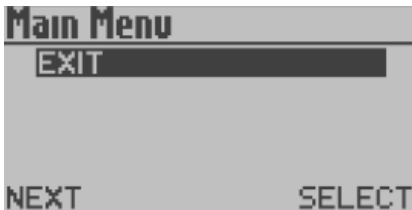

Checkpoint

You can safely remove the front cover of the Sentro Wireless for setup in a hazardous area, even with the power applied.

Checkpoint

The Sentro Wireless will automatically return to the Main Display if no keys are pressed within 30 seconds. The time limit is extended to 8 minutes during Calibrate to allow the gas value displayed on the LCD screen time to stabilise.

4.5.1 Calibrate

This enables you to Calibrate the Sentro Wireless.

From the Main Menu press L, navigate to Calibrate and press R to enter the Calibrate Menu.

4.5.1.1 Calibrate

Calibrate the Zero and Span values of the Sentro Wireless using clean air and test gas of a known concentration.

Checkpoint

Ensure the area where the Sentro Wireless is being calibrated is well ventilated. Observe applicable local Health and Safety legislation and applicable local procedures when handling test gases.

Use a cross head screwdriver and remove the four screws securing the front cover and swing it out of the way. Fit a gas hood to the front of the Sentro eModule, the gas hood is a push fitting.

Using suitable tubing connect a cylinder of clean air test gas to the gas hood fitted to the Sentro eModule.

Open the valve and apply clean air at a rate of 0.5 litre/min. Wait for the reading to settle at a stable value.

Press R to Zero the displayed value. Wait for the reading to stabilise at zero.

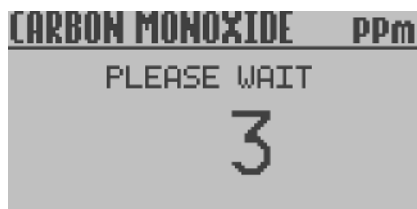
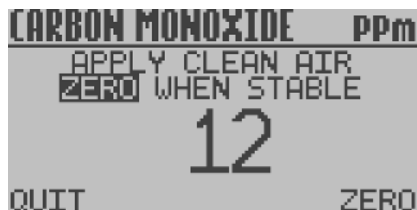

CARBON MONOXIDE ppm
ZERO DONE
REMOVE CLEAN AIR
QUIT SPAN

Shut the valve and stop the supply of clean air. Disconnect the application tubing from the gas hood.

Press R to go to Calibrate Span.

Checkpoint

Press L at any time to Quit and return to the Main Menu.

4.5.1.2 Calibrate Span - Using Test Gas of Current Value

Checkpoint

Refer to page 52 for details of the calibration gas to be used. Methane **MUST** be in balanced air in order for the pellistor sensor to function correctly.

CARBON MONOXIDE ppm
Expected span gas is
250 PPM
CHANGE QUIT NEXT

The screen will show the concentration of Span Gas that is expected to be used.

Check the value of Span Gas displayed and compare it against the value shown on the test gas cylinder.

If the values match press R. If the values **DO NOT** match follow the instructions in the section Calibrate Span - Using Test Gas of a Different Value.

Using suitable tubing connect a cylinder of test gas to the gas hood fitted to the Sentro eModule.

Open the valve and apply test gas at a rate of 0.5 litre/min.

Wait for the reading to settle at the stable value (Not necessarily the test gas value).

Press L and Span the displayed value. If the displayed value continues to shift press L again.

Shut the valve and stop the supply of test gas. Disconnect the application tube from the gas hood and remove the gas hood.

4.5.1.3 Calibrate Span - Using Test Gas of a Different Value.

The screen will show the concentration of Span Gas that is expected to be used.

Check the value of Span Gas displayed and compare it against the value shown on the test gas cylinder. If the values do not match press L.

Press L to increment each digit.

Press R to move to the next digit.

When the last digit is set, press R to select Done and return to the Calibrate Menu.

Continue with Calibrate Span as described in the previous section Calibrate Span - Using Test Gas of Current Value.

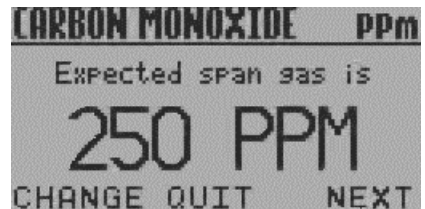
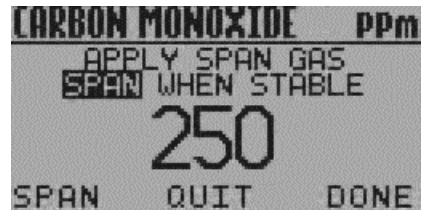

4.5.2 TX6355 Setup

This enables you to Setup the TX6355 Sentro Wireless.

Use a cross head screwdriver and remove the four screws securing the front cover and swing it out of the way. From the Main Menu press L, navigate to TX6355 Setup and press R to enter the TX6355 Setup Menu.

The available menus are as follows:

- System Information
- Display Setup
- Alert Setup
- Set Security Code
- Exit

4.5.2.1 System Information

This displays basic information about the system including the main software version, system date, system time, driver versions and output formats.

From the TX6355 Setup Menu press L, navigate to the System Information and press R to display the System Information.

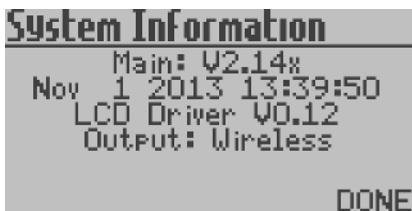
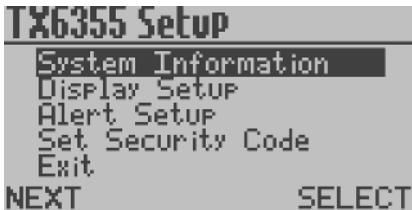

4.5.2.2 Display Setup Menu

This enables you to Setup the Display of the TX6355 Sentro Wireless.

From the TX6355 Setup Menu press L, navigate to the Display Setup and press R to enter the Display Setup Menu.

The available menus are as follows:

- Set Backlight
- Adjust Contrast
- Exit

Set Backlight

The screen backlight illumination may be set to On or Off, to reduce power consumption.

From the Display Setup Menu press L, navigate to Set Backlight and press R to enter the Set Backlight Menu.

From the Set Backlight Menu press R to set the Backlight Illumination to On or Off as required.

Press L to move to Save or Cancel as required. Press R to confirm the selection and return to the Display Setup Menu.



Adjust Contrast

The contrast of the screen may be set for best visual appearance.

From the Display Setup Menu press L, navigate to Adjust Contrast and press R to enter the Adjust Contrast Menu.

Press L to navigate to Increase or Decrease as required. Press R to Increase or Decrease the contrast as required.

Press L and select Save or Cancel as required. Press R to confirm the selection and return to the Display Setup Menu.

Exit

From the Display Setup Menu press L, navigate to Exit, press R to confirm the selection and return to the TX6355 Setup Menu.

4.5.2.3 Alert Setup Menu

This enables you to carry-out the setup of the Alerts.

From the TX6355 Setup Menu press L, navigate to Alert Setup and press R to enter the Alert Setup Menu.

The available menus are as follows:

- Visual Alert
- Confidence Alarm
- Exit



Visual Alert

The integral General and High visual alarms can be set to On or Off.

From the Alert Setup Menu press L, navigate to Visual Alert and press R to enter the Visual Alert Menu.

From the Visual Alert Menu press R to set the Visual Alert to On or Off as required.

Press L and navigate to Save or Cancel as required. Press R to confirm the selection and return to the Alert Setup Menu.

Confidence Alarm

The Confidence Alarm flash can be set to On or Off.

From the Alert Setup Menu press L, navigate to Confidence Alarm and press R to enter the Confidence Alarm Menu.

From the Confidence Alarm Menu press R to set the Visual Alert to On or Off as required.

Press L to move to Save or Cancel as required.

Press R to confirm the selection and return to the Alert Setup Menu.

Exit

From the Alert Setup Menu press L, navigate to Exit and press R to confirm the selection and return to the TX6355 Setup Menu.

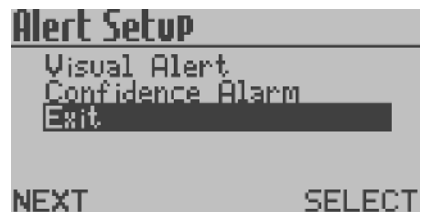
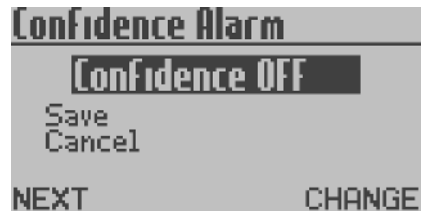
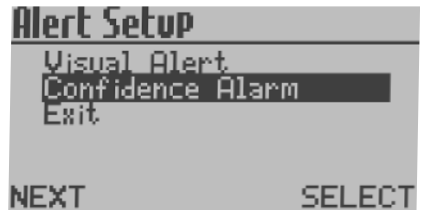
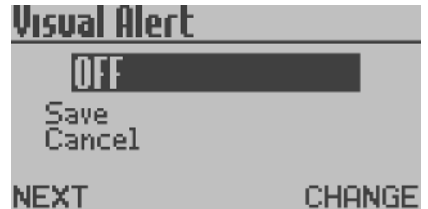
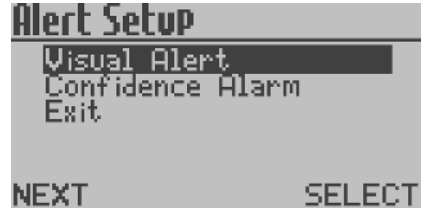



4.5.2.4 Set Security Code

This enables you to enter a Security Code and prevent unauthorised access to the Main Menu.

From the TX6355 Setup Menu press L, navigate to Set Security Code and press R to enter Set Security Code.

From Set Security Code press R to increment the first digit. Press L to confirm the selection and move to the next digit.

Repeat for all four digits. Press L and navigate to Save or Cancel as required and press R to confirm the selection.

4.5.2.5 Exit

From the TX6355 Setup Menu press L, navigate to Exit, press R to confirm the selection and return to the Main Menu.

4.5.3 Modbus Address

The Modbus Address can be set between 1 and 255 as required.

From the Output Setup Menu press L, navigate to Modbus Address and press R to enter the Modbus Address Menu.

Press L to navigate to Increase or Decrease as required. Press R to Increase or Decrease the Modbus Address as required.

Press L and navigate to select Save or Cancel as required. Press R to confirm the selection and return to the Output Setup Menu.

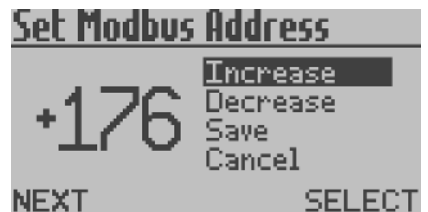
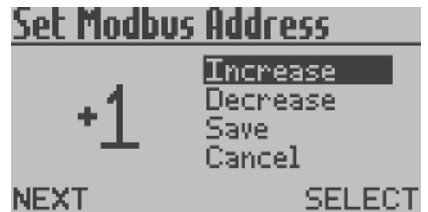

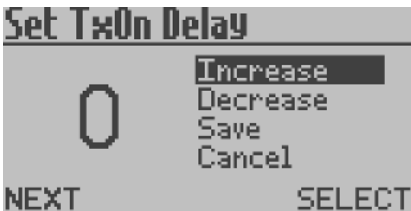
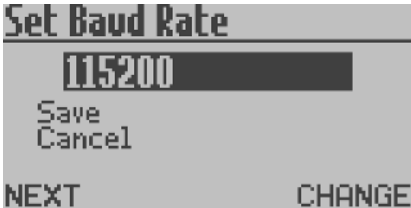
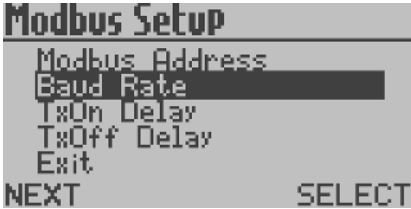

4.5.3.1 Baud Rate

The Baud Rate can be set to 300/600/1200/2400/4800/9600/14400/19200/28800/38400/57600/115200 as required.

From the Output Setup Menu press L, navigate to Baud Rate and press R to enter the Set Baud Rate Menu.

Press R to navigate to the required Baud Rate, press L and select Save or Cancel as required. Press R to confirm the selection and return to the Output Setup Menu.

4.5.3.2 TxOn Delay and TxOff Delay

Checkpoint
TxOn Delay and TxOff Delay are configured in exactly the same way as each other.

The TxOn Delay and TxOff Delay can be set between 0 and 99 ms.

From the Output Setup Menu press L, navigate to TxOn Delay or TxOff Delay as required and Press R to enter the TxOn Delay or TxOff Delay Menu as required.

Press L to navigate to Increase or Decrease as required. Press R to Increase or Decrease as required. Press L and select Save or Cancel as required. Press R to confirm the selection and return to the Output Setup Menu.

4.5.3.3 Exit

From the Output Setup Menu press L, navigate to Exit, press R to confirm the selection and return to the Main Menu.

4.5.4 Module Setup

This enables you to Setup the functional values of the Sentro eModule fitted to Sentro Wireless.

From the Main Menu press L, navigate to Module Setup and press R to enter the Module Setup Menu.

The available menus are as follows:

- Setpoint 1
- Setpoint 2
- STEL & TWA
- Exit

4.5.4.1 Setpoint 1 and Setpoint 2

This enables you to carry-out a setup of Setpoint 1 and Setpoint 2.

From the Module Setup Menu press L, navigate to Setpoint 1 or Setpoint 2 and press R to enter the Setpoint 1 or Setpoint 2 Setup Menu.

The available menus are as follows:

- Activation
- Level
- Exit

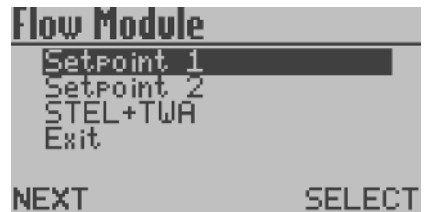
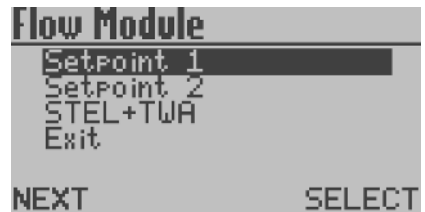



Activation

The Activation cause of Setpoint 1 and Setpoint 2 can be configured.

From the Setpoint 1 or Setpoint 2 Setup Menu press L, navigate to Activation and press R.

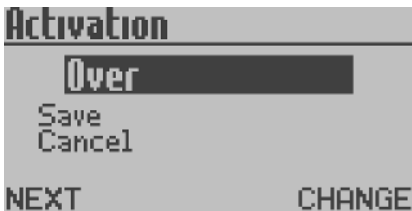

From the Activation Menu press R to set Activation to Over or Under as required.

Press L and navigate to Save or Cancel as required. Press R to confirm the selection and return to the Setpoint 1 or Setpoint 2 Setup Menu.

Checkpoint

Setpoint 2 activation is configured in exactly the same way as Setpoint 1 activation.



Level

The Level at which Setpoint 1 and Setpoint 2 are activated can be configured.

From the Setpoint 1 or Setpoint 2 Setup Menu press L, navigate to Level and press R.

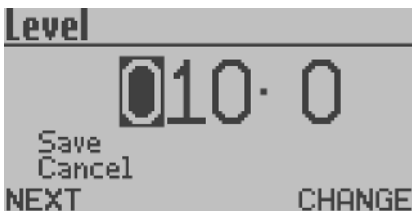

Press R to increment the digits as required.

Press L to move to the next digit. Repeat for all digits and press L.

Press L and select Save or Cancel as required. Press R to confirm the selection and return to the Setpoint 1 or Setpoint 2 Setup Menu.

Checkpoint

Setpoint 2 activation is configured in exactly the same way as Setpoint 1 activation.

Exit

From the Setpoint 1 or Setpoint 2 Setup Menu press L, navigate to Exit, press R to confirm the selection and return to the Module Setup Menu.



4.5.4.2 STEL & TWA

This enables you to control the STEL & TWA functions.

Checkpoint

Selected gas sensors are equipped to automatically calculate STEL and TWA limits in accordance with COSHH standards. If the facility is selected for use, ensure that all accumulated data is reset to zero before the start of a working period.

From the Module Setup Menu press L, navigate to STEL & TWA and press R to enter the STEL & TWA Setup Menu.

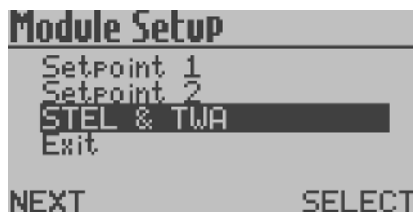

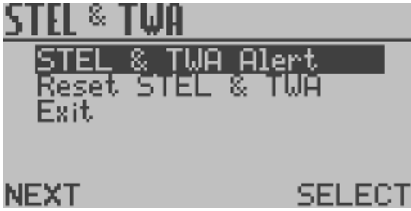

The available menus are as follows:

- STEL & TWA Alert
- Reset STEL & TWA
- Exit

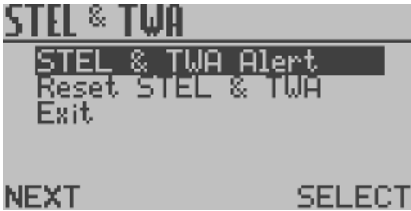

STEL & TWA Alert

The STEL & TWA Alert can be configured to activate or not when the STEL & TWA levels are reached.

From the STEL & TWA Setup Menu press L, navigate to STEL & TWA Alert and press R to enter the STEL & TWA Setup Menu.

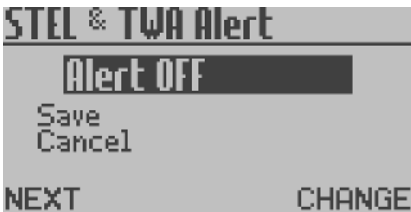

From the STEL & TWA Alert Menu press R to set the STEL & TWA Alert to On or Off as required.

Press L and navigate to Save or Cancel as required. Press R to confirm the selection and return to the STEL & TWA Setup Menu.

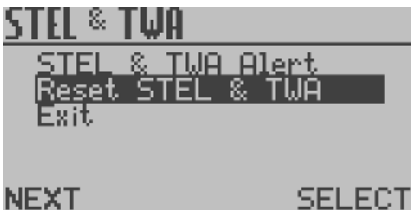

Reset STEL & TWA

The STEL & TWA should be reset at the start of a working period.

From the STEL & TWA Setup Menu press L, navigate to Reset STEL & TWA and press R.



The STEL & TWA are now reset. Press R to select Done and return to the STEL & TWA Setup Menu.

Exit

From the STEL & TWA Setup Menu press L and navigate to Exit. Press R to confirm the selection and return to the Module Setup Menu.

4.5.4.3 Exit

From the Module Setup Menu press L, navigate to Exit and press R to confirm the selection and return to the Main Menu.

4.5.5 CommTrac

This displays the system settings of the CommTrac wireless communication system fitted the Sentro Wireless sensor.

From the Main Menu press L, navigate to CommTrac and press R to enter the CommTrac Setup Menu.

The available menus are as follows:

- Comms
- Firmware Versions
- CN RSSI
- Xmit Freq
- Voltages
- I/O #1
- I/O #2
- Location Msg Interval
- Sensor Msg Interval
- Sensor Polling Interval
- Mute Alarm
- Exit

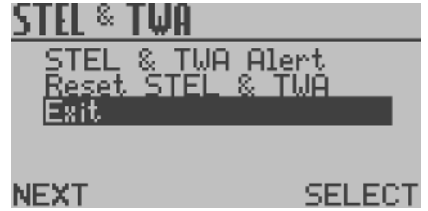

Comms

```
Node ID: 000000
#Rcv Comm Node: 0
```

DONE

4.5.5.1 Comms

From the CommTrac Setup Menu press L, navigate to Comms and press R to enter the Comms Menu.

This displays the Node ID of the Sentro Wireless sensor on the CommTrac wireless network. It also displays the Number of Received Comm Node which is the number of nodes that the Sentro Wireless can see on the CommTrac network.

Firmware Versions

```
PIC SW ver: 0.0.0
CC1110 SW ver: 0.0.0
```

DONE

4.5.5.2 Firmware Versions

From the CommTrac Setup Menu press L, navigate to Firmware Versions and press R to enter the Firmware Versions Menu.

This displays the software versions for the PIC Software and CC1110 Software for the CommTrac system.

CN RSSI

```
CN RSSI: -100 dBm
```

DONE

4.5.5.3 CN RSSI

From the CommTrac Setup Menu press L, navigate to CN RSSI and press R to enter the CN RSSI Menu.

This displays the strength of the wireless signal the gas detector is receiving from the CommTrac node. The value displayed will be between -100 (weak signal) to 0 (strong signal).

4.5.5.4 Xmit Freq

From the CommTrac Setup Menu press L, navigate to Xmit Freq and press R to enter the Xmit Freq Menu.

This displays frequency in MHz that the Sentro Wireless has been configured to transmit to the CommTrac node on. The range displayed will be 868 to 925 MHz.

*NOTE The current TX6355 hardware is only capable of operating between 902 MHz and 928 MHz. DO NOT ATTEMPT TO SET THE OPERATING FREQUENCY OUTSIDE OF THIS RANGE.

This parameter is configured during manufacture. It is user configurable but Trolex strongly recommends that users DO NOT alter the configured frequency.

4.5.5.5 Voltages

From the CommTrac Setup Menu press L, navigate to Voltages and press R to enter the Voltages Menu.

This displays voltages for the Sentro Wireless, including the Battery Voltage, External Voltage and Power Source type.

The Battery Voltage would normally be in the range 0 to 6.5 V. If the Sentro Wireless is operating from the internal battery the External Voltage would be displayed as 0 V. If the Sentro Wireless is operating from the external power source the External Voltage would be displayed as 10 V.

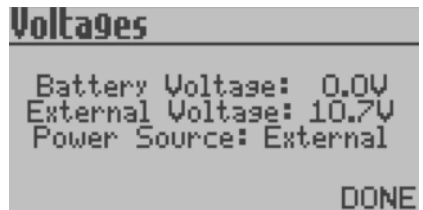
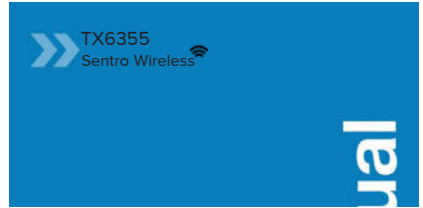

```

I/O #1
-----
Type: NonAlarming
Status: 0

TEST                               DONE

```

4.5.5.6 I/O #1 and I/O #2

From the CommTrac Setup Menu press L, navigate to I/O #1 or I/O #2 and press R to enter the I/O #1 or I/O #2 Menu.

Checkpoint

I/O #1 and I/O #2 are configured in exactly the same way.

This displays the configuration and status of I/O #1 and I/O #2 of the CommTrac wireless module fitted to the Sentro Wireless. The configuration is on of the following:

- Alarming
- Non Alarming
- Confidence Alert
- Visual Alarm
- Sounder Alarm

```

I/O #1
-----
Type: NonAlarming
Busy Performing Test

DONE

```

Press L to start a Test to verify if the Sentro Wireless is communicating with the wireless network. A Test result of Busy, Passed, Failed or Timed Out will display once the Test is completed.

4.5.5.7 Location Msg Interval

From the CommTrac Setup Menu press L, navigate to Location Msg Interval and press R to enter the Location Msg Interval Menu.

This is a user configurable parameter. This is how often (in minutes) the I/O board will queue a CommTrac location message. The default value for this parameter is 1440 minutes. The range is 1 to 32767. This parameter can also be set via a CommTrac over-the-air message.

Press R to increment the digits as required. Press L to move to the next digit. Repeat for all digits, press L and select Save or Cancel as required. Press R to confirm the selection and return to the CommTrac Setup Menu.

4.5.5.8 Sensor Msg Interval

From the CommTrac Setup Menu press L, navigate to Sensor Msg Interval and press R to enter the Sensor Msg Interval Menu.

This is a user configurable parameter to define how often (in seconds) the I/O board will queue a CommTrac sensor message when there are no alarms. If there are alarms a sensor message is generated as soon as the I/O board sees them via polling of the Sentro Wireless. The default value for this parameter is 90 seconds. The range is 10 to 32767. This parameter can also be set via a CommTrac over-the-air message.

Press R to increment the digits as required. Press L to move to the next digit. Repeat for all digits, press L and select Save or Cancel as required. Press R to confirm the selection and return to the CommTrac Setup Menu.

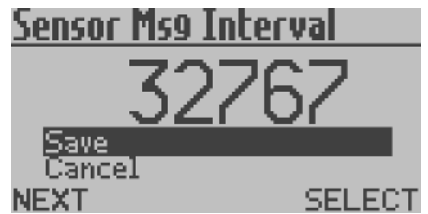

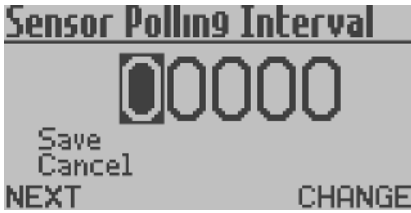

4.5.5.9 Sensor Polling Interval

From the CommTrac Setup Menu press L and navigate to Sensor Polling Interval, press R to enter the Sensor Polling Interval Menu.

This is a user configurable parameter to define how often (in seconds) the I/O board polls the Sentro Wireless for sensor data, alarms and parameter changes. Between polling the Sentro Wireless, the I/O board is in a low power mode. Any changes made to this parameter via the Sentro Wireless controls will not be applied, the value is currently hard coded at 5 seconds.



4.5.5.10 Mute Alarm

From the CommTrac Setup Menu press L, navigate to Mute Alarm and press R to enter the Mute Alarm Menu.

This will clear any I/O's that are set as Alarming I/O's until another event re-sets that Alarming I/O

Press R to change the configuration between Alarm Muted and Alarm Not Muted as required.

Press L and navigate to Save or Cancel as required. Press R to confirm the selection and return to the CommTrac Setup Menu.

4.5.5.11 Exit

From the CommTrac Setup Menu press L, navigate to Exit, press R to Exit and return to the Main Menu.

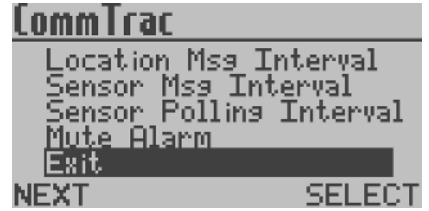

4.5.6 Exit

From the Main Menu press L, navigate to Exit and press R to confirm the selection and return to the Main Display.



4.6 Support

If you need technical support to operate this product, or would like details of our after sales technical support packages, please contact your local Trolex service agent or service@trolex.com.

5. Diagnostics and Maintenance

5.1 Diagnostic Messages

Sensor Over-range

If the Sentro Wireless detects gas levels above the safe working limit of the sensing element:



Pellistor Gas Sensor

- The transmitted output signal from the sensor will be clamped at full scale to prevent ambiguous output data from being transmitted and will latch in this condition
- The pellistor in the gas sensing module will be switched into a protect state to prevent oxidisation damage. The pellistor will automatically reset after 600 seconds and will latch in this state
- Check that the gas concentration has receded, then reset the eModule by removing it for 2 seconds



Electrochemical, Infrared or LED Infrared Gas Sensor

- The screen will display the error message

Loss of Signal From the Sensor

If there is a loss of signal from the eModule to the Sentro Wireless an error message will be shown.



MODULE NOT FITTED

Module Not Fitted

If the eModule has been removed from the Sentro Wireless and is out for more than 10 seconds an error message will be shown.



MODULE NOT FITTED

5.1.2 Sensor Negative Drift

The Sentro Wireless will display a fault indication as shown if the sensor experiences a negative drift below zero equivalent to 10% of the measuring range.



CARBON MONOXIDE PPM

<<F

5.1.3 Recovery from Display Freeze

If the display freezes, it may be unfrozen by pressing and holding the L and R buttons simultaneously for about 10 seconds.

5.2 Maintenance

5.2.1 Introduction

To keep your Sentro Wireless in the best possible condition and minimise downtime, Trolex strongly recommends that you carry out regular planned preventative maintenance and keep records of the maintenance carried out.

The planned preventative maintenance for Sentro Wireless consists of a number of tasks carried out at regular intervals on a cumulative basis, ie at 12 months do the 1 month jobs AND the 12 month jobs. These tasks are listed in the maintenance schedule below:

Equipment Name	Task Type	Task Number	Interval
Sentro Wireless gas inlet port	Check and Clean	5.2.2	1 month
Sentro Wireless	Bump Test	5.2.3	1 month
Sentro Wireless batteries	Replace	5.2.4	40 days
Sentro eModule	Calibrate	5.2.5	6 months
Sentro Wireless	Safety Check	5.2.6	12 months
Sentro eModule	Replace	5.2.7	
	Pellistor		60 months
	Electrochemical		12 to 24 months
	Infra red		up to 60 months

5.2.2 Gas Inlet Port - Check & Clean

1. Check the condition of the gas inlet port and repair or replace as necessary.
2. Clean the gas inlet port with a small brush to remove dust and debris.
3. After the completion of all maintenance, update the maintenance records.



Note: The gas inlet port should be cleaned as required when dust or water ingress is suspected, but at a minimum of one monthly intervals. It is recommended that the sensor face of the eModule is also inspected and cleaned. The eModule may be accessed by opening the front cover.

5.2.3 Bump Test

1. With the Sentro Wireless powered-up, note the background gas level on the LCD screen.
2. Spray a 10 second burst of test gas on to the gas port.
3. On the LCD screen check that the gas concentration reading rises and then falls back to the background level. This may take up to 25 seconds from the end of the burst of test gas.
4. After the completion of all maintenance, update the maintenance records.

Note: When a Carbon Monoxide eModule is fitted, in order to comply with performance standard ANSI/ISA 92.00.01, ensure that any bump test verifies that the accuracy is within +/- 6 ppm or +/- 10% of the reading, whichever is the largest.



Checkpoint

If the Sentro Wireless fails the test, replace the defective eModule with a working eModule of the same type and repeat the bump test on the replaced eModule.

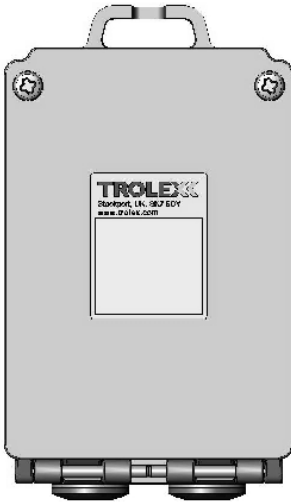

5.2.4 Replacing the Batteries

1. On the back of the Sentro Wireless remove the two captive screws located in the top corners of the back panel.
2. Swing the back panel down.
3. Remove the four D cell batteries located in the battery box.
4. Fit four new D cell batteries to the battery box.

Checkpoint

Only fit Energiser E95/EN95 batteries. Do not mix old and new batteries – only fit as sets of four.

5. Swing the back panel into place and secure using the two screws.
6. Tighten the screws firmly but do not overtighten.
7. Check the Sentro Wireless is showing a gas concentration reading on the screen.
8. Check no error messages are being displayed.
9. After the completion of all maintenance, update the maintenance records.

5.2.5 Sentro eModule - Calibrate

1. Calibrate the Sentro eModule in accordance with the instructions in section 4.5.1.
2. Replace any eModule that fails the calibration.
3. eModules may be pre-calibrated at any location convenient to the user, and installed in another location at some later date.

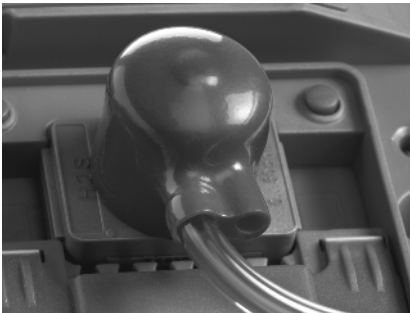

A bump test should be performed to confirm functionality.

4. eModule calibration is good for 6 months from the date of calibration, regardless of when the eModule is placed in service during those 6 months.
5. After the completion of all maintenance, update the maintenance records.

5.2.6 Safety Check

1. The Sentro Wireless will not normally require maintenance or calibration, but it is advisable to return it to your local approved distributor for an annual safety check.
2. After the completion of all maintenance, update the maintenance records.

5.2.7 Sentro eModule - Replace

1. The Sentro eModules should be changed at regular intervals to ensure the accuracy of response.
2. Service history is logged within the eModule and this data is used to periodically assess its condition whenever it is returned for servicing.
3. Simply open the front cover, insert the new eModule into the Sentro Wireless and return the removed eModule for checking and calibration.
4. After the completion of all maintenance, update the maintenance records.

Checkpoint

The replacement period of 60 months for the Pellistor and Infra red eModules, and 12 to 24 months for electrochemical eModule, is dependent on ambient conditions. Gaining knowledge and experience of the condition of eModules when they are replaced will allow you to fine tune this periodicity to suit your location.

5.3 Recommended Test Gas Concentrations

eModule Type	eModule Range	Zero Gas	Span Gas
Carbon dioxide	0 to 2% v/v	Nitrogen 100%	CO ₂ - 1% v/v
Carbon monoxide	0 to 50 ppm	Clean air	CO - 25 ppm
Hydrogen sulphide	0 to 50 ppm	Clean air	H ₂ S - 25 ppm
Methane	0 to 4% v/v	Clean air	CH ₄ - 2% v/v in balanced air
Methane	0 to 100% LEL (4.4% v/v)	Clean air	CH ₄ - 2.2% v/v in balanced air
Methane	0 to 100% LEL (5% v/v)	Clean air	CH ₄ - 2.5% v/v in balanced air
Nitric oxide	0 to 50 ppm	Clean air	NO - 50 ppm
Nitrogen dioxide	0 to 20 ppm	Clean air	NO ₂ - 20 ppm
Oxygen	0 to 25% v/v	Nitrogen 100%	O ₂ - 25% v/v
Sulphur dioxide	0 to 20 ppm	Clean air	SO ₂ - 20 ppm

Standard test gas canisters are available from our Product Support department and can be supplied in a range of capacities from 34 litres up to 110 litres.

Please contact your local Trolex service agent or service@trolex.com for advice regarding recommended test gas procedures and product support plans.

Checkpoint

The calibration gas shown is the recommended level of concentration. Any concentration gas down to 50% of full scale can be utilised for accurate calibration.

5.4 Disposal

Part of the ethos of Trolex is sustainable design. Sentro Wireless contains materials that can be recovered, recycled and reused. At the end of its useful life ensure that the Sentro Wireless is recycled in accordance with local laws and bylaws for the geographic area where it is located. The end of its useful life is to be determined by the owner/operator of the equipment and not Trolex. Ensure that the Sentro Wireless is recycled by licenced waste contractors with the appropriate licences for handling electronic waste in the geographic area where the Sentro Wireless is located.

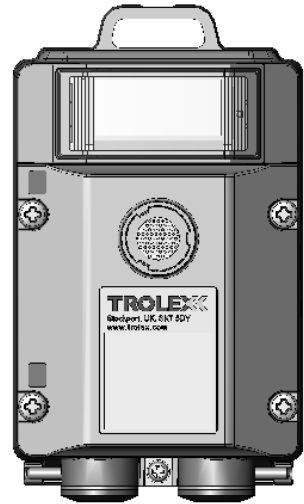

Checkpoint

Consult your local Trolex service agent or the Trolex Product Support Department if you require assistance with disposal:
service@trolex.com

5.5 Maintenance Records

Implement a planned preventative maintenance process and keep good maintenance records.

Consult your local Trolex service agent or the Trolex Product Support Department:
service@trolex.com for help in implementing a planned preventative maintenance process.

The 'Maintenance Log' gives an example of a typical maintenance record system.

Disclaimers

The information provided in this document contains general descriptions and technical characteristics of the performance of the product. It is not intended as a substitute for and is not to be used for determining suitability or reliability of this product for specific user applications. It is the duty of any user or installer to perform the appropriate and complete risk analysis, evaluation and testing of the products with respect to the relevant specific application or use. Trolex shall not be responsible or liable for misuse of the information contained herein. If you have any suggestions for improvements or amendments, or find errors in this publication, please notify us at marketing@trolex.com.

No part of this document may be reproduced in any form or by any means, electronic or mechanical, including photocopying, without express written permission of Trolex.

All pertinent state, regional, and local safety regulations must be observed when installing and using this product. For reasons of safety and to help ensure compliance with documented system data, only Trolex or its affiliates should perform repairs to components.

When devices are used for applications with technical safety requirements, the relevant instructions must be followed.

Trademarks

© 2018 Trolex® Limited.

Trolex is a registered trademark of Trolex Limited. The use of all trademarks in this document is acknowledged.

Document History

Version	Date	ECR
A	26 Feb 2018	4545
B	14 Jul 2020	5009
C	01 Feb 2023	5428

Contact Details

Trolex Ltd, Newby Road, Hazel Grove, Stockport, Cheshire, SK7 5DY, UK

+44 (0) 161 483 1435 sales@trolex.com

TROLEX«

Trolex Ltd. Newby Road, Hazel Grove, Stockport, Cheshire SK7 5DY, UK
t: +44 (0)161 483 1435 **e:** sales@trolex.com www.trolex.com