

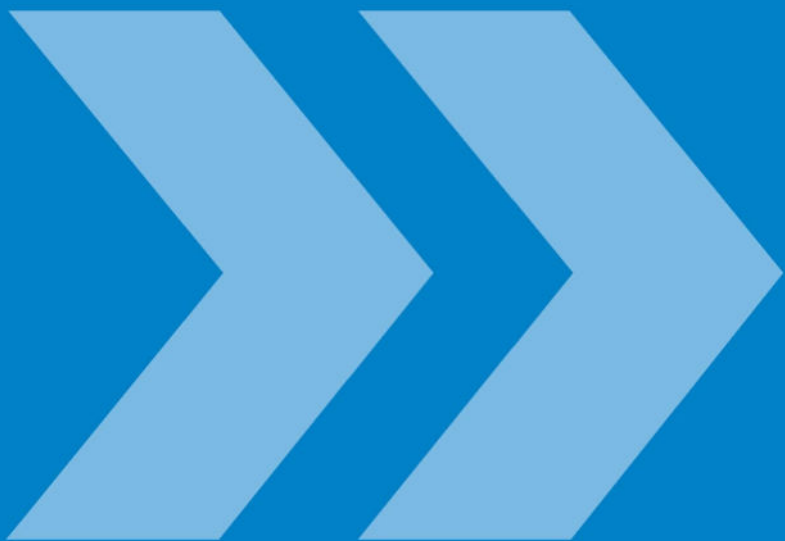

**TX6356**

Sentro Humidity Sensor



**TROLEX**«

# User Manual



# TX6356 Sentro Humidity Sensor

## Contents

<b>1. Product Overview</b>	<b>4</b>	4.5.2 Output Setup	27
1.1 Operating Features	5	4.5.3 Module Setup	38
1.2 Application	5	4.5.4 Exit	45
1.3 Product Options	5	4.6 Support	45
1.4 Dimensions	6	<b>5. Operation</b>	<b>46</b>
1.5 Technical Information	7	5.1 Dual Relay Contact Output Signal	46
1.6 Electrical Details	8	5.1.1 To Reset a Latched Relay	46
1.7 Sentro Module	9	<b>6. Diagnostics and Maintenance</b>	<b>48</b>
<b>2. Certification</b>	<b>10</b>	6.1 Diagnostic Messages	48
2.1 Australia	10	6.2 Maintenance	48
<b>3. Installation</b>	<b>12</b>	6.2.1 Introduction	48
3.1 Safety Precautions	12	6.2.2 Sentro Humidity Sensor - Check	49
3.2 Tools and Test Equipment Required	12	6.2.3 Sentro Humidity Sensor - Clean	50
3.3 Siting Recommendations	12	6.2.4 Sentro Humidity Sensor Output Signal - Check	50
3.4 Connections	13	6.2.5 Sentro Humidity Sensor - Function Test	51
3.4.1 0.4 to 2 V Analogue Output Signal	13	6.3 Disposal	51
3.4.2 4 to 20 mA Analogue Output Signal	13	6.4 Maintenance Records	52
3.4.3 5 to 15 Hz Output Signal	14	6.5 Maintenance and Calibration Log	53
3.4.4 Dual Relay Contact	14	<b>Disclaimers</b>	<b>54</b>
3.4.5 RS485 Data Output Signal	14	<b>Trademarks</b>	<b>54</b>
<b>4. Setup and Calibration</b>	<b>16</b>	<b>Contact Details</b>	<b>54</b>
4.1 Controls and Indicators	16	<b>Document History</b>	<b>54</b>
4.2 Software Menus	18		
4.3 Navigation	19		
4.4 Power-up	20		
4.5 Main Menu	21		
4.5.1 Sentro Setup	22		

## 1. Product Overview

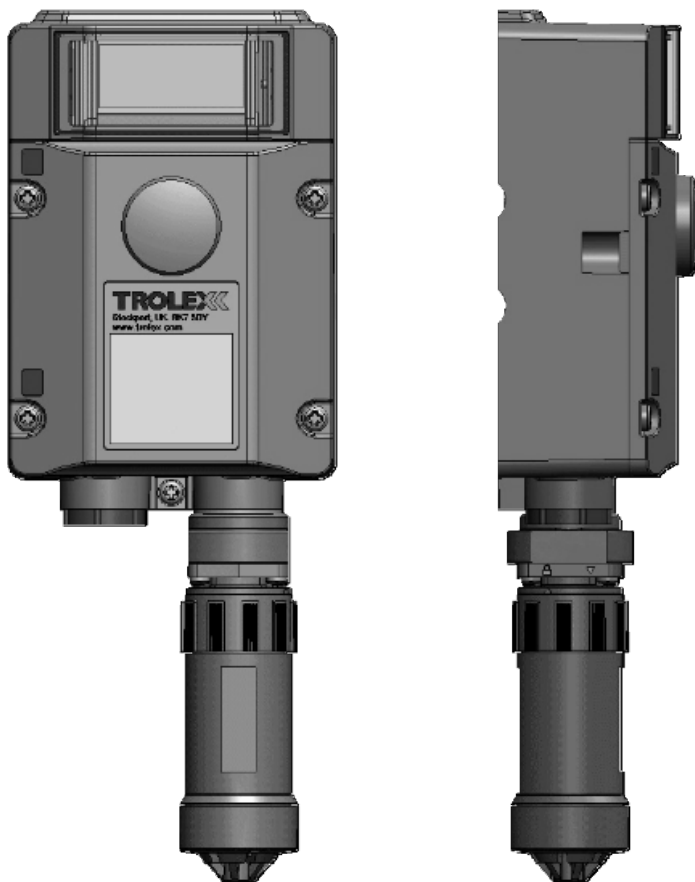

---

**TX6356.06.**  
**01/02/03/04/05/06**

Sentro Humidity Sensor with bottom projecting sensor head. For safety monitoring of humidity, in heavy duty applications. 12 V dc - intrinsically safe - Group I Underground Mining (AUS)

---

**TX6356.01.**  
**01/02/03/04/05/06**

Sentro Humidity Sensor with bottom projecting sensor head. For safety monitoring of humidity, in heavy duty applications. 12 V dc - intrinsically safe - Group I Underground Mining (ATEX)

---

## 1.1 Operating Features

- High accuracy humidity sensor with calibrated input sensing modules
- Choice of output signals:
  - 0.4 to 2 V analogue
  - 4 to 20 mA analogue
  - 5 to 15 Hz analogue
  - RS485 addressable Modbus datacomms
  - Dual relay contacts
- Large backlit LCD screen provides clear sensor information and diagnostic data
- Two programmable setpoints for inbuilt visual alarms
- Easy access terminal chamber with large, vibration secure, terminals for connecting heavy plant cables
- Sensing range: 10 to 90% RH non-condensing
- Sensing accuracy: +/- 5%

## 1.2 Application

Fixed point humidity sensor for safety monitoring of humidity in heavy-duty applications. Suitable for use in mining, storage areas, process plants, utilities and oil & gas.

## 1.3 Product Options

### Bottom Projecting Sensor

#### Order Reference

Output	Group I Underground Mining Ex ia (AUS)	Group I Underground Mining Ex ia (ATEX)
4 to 20 mA output	TX6356.06.01	TX6356.01.01
0.4 to 2 V output	TX6356.06.02	TX6356.01.02
5 to 15 Hz output	TX6356.06.03	TX6356.01.03
RS485 output	TX6356.06.04	TX6356.01.04
Dual relay contacts - normally closed	TX6356.06.05	TX6356.01.05
Dual relay contacts - normally open	TX6356.06.06	TX6356.01.06

## 1.4 Dimensions

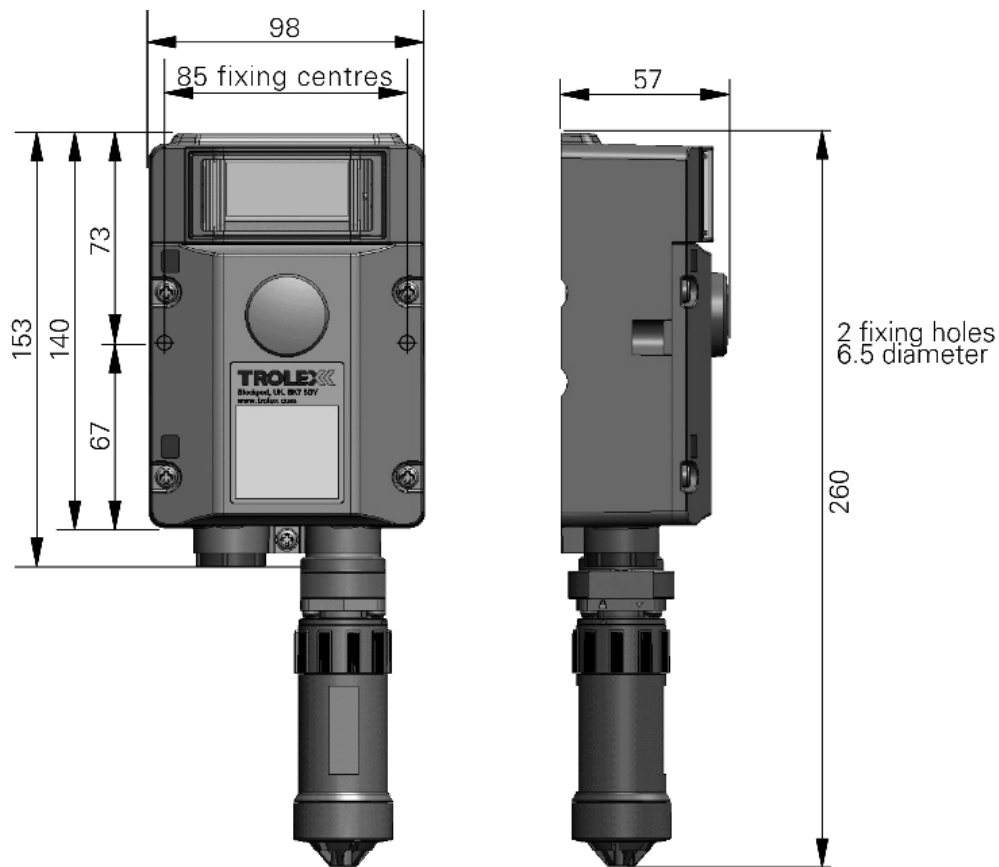

All dimensions in mm

## 1.5 Technical Information

Humidity sensing range	10 to 90% non-condensing
Accuracy	+/- 5%
Linearity	±2% FS
Operating temperature range	-20 to +40°C
Storage temperature limits	-20 to + 60°C
Protection classification	Housing - dust and waterproof to IP65 Sensor head - protected to IP54
Housing material	Reinforced polymer
Sensor housing material	Polycarbonate
Nett weight	750 g
Information display	128 x 64 dot graphic backlit LCD screen
Mounting	Two 6.5 mm diameter fixing holes with Unistrut 6946 indents
Cable entries	1 x M20
Electrical connections	4 mm barrier/clamp terminals with circuit segregation barriers
Conductors	A maximum of two per terminal
Conductor size	A maximum of 2 x 2.5 mm <sup>2</sup>
Terminal torque	<ul style="list-style-type: none"> <li>• 2.4 Nm maximum</li> </ul>
Vibration limits	Vibration limits (EN 60079-29-1): <ul style="list-style-type: none"> <li>• 10 to 30 Hz - 1.00 mm total excursion</li> <li>• 31 to 150 Hz - 19.6 m/s<sup>2</sup> acceleration peak</li> </ul>
Impact limits	20 joules (housing)
Output Signals	<ul style="list-style-type: none"> <li>• 0.4 to 2 V</li> <li>• 4 to 20 mA</li> <li>• 5 to 15 Hz</li> <li>• Dual relay contacts (normally open OR normally closed)</li> <li>• RS485 data</li> </ul>
Alarms	Programmable <b>General</b> and <b>High</b> alarm levels with LED indicators

Menu configuration	<ul style="list-style-type: none"> <li>• Security code protection</li> <li>• Setpoint level and mode adjustment</li> <li>• Data output protocol configuration</li> <li>• Flow units selection</li> <li>• Duty display text entry</li> </ul>
Fault indication	<ul style="list-style-type: none"> <li>• Loss of communications</li> <li>• Sensing module absent</li> <li>• Sensor over-range</li> </ul>

## 1.6 Electrical Details

### 0.4 to 2 V Output Signal - 3/4 wire - remote powered

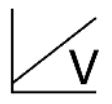

Supply voltage	Group I	10 to 14 V dc
Minimum line load	Group I	10 K ohms
Supply current	Group I	20 mA @ 12 V dc

### 4 to 20 mA Output Signal - 3/4 wire - remote powered



Supply voltage	Group I	10 to 14 V dc
Maximum line load	Group I	220 ohm at 12 V dc
Supply current	Group I	48 mA @ 12 V dc

### 5 to 15 Hz Output Signal - 3/4 wire - remote powered

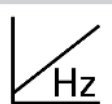

Supply voltage	Group I	10 to 14 V dc
Maximum line load	Group I	Opto isolated to 2 mA maximum
Supply current	Group I	20 mA @ 12 V dc

### Dual Relay Contacts



	Supply voltage	Group I	10 to 14 V dc
	Contact rating	Group I	5 A at 230 V dc
	Supply current	Group I	60 mA

RS485 Data Output			
	Supply voltage	Group I	10 to 14 V dc
	Data protocol	Group I	RS485 Modbus
	Supply current	Group I	25 mA

## 1.7 Sentro Module

Plug-in pre-calibrated sensing module with standardised output data.

- The sensing module stores all the necessary data about its type identification, sensing range and specific calibration. This data is automatically recognised by the Sentro when the sensing module is loaded into the module bay
- The sensing modules are pre-calibrated so they can be replaced at any time by a replacement sensing module
- The sensing module will identify itself when plugged into the sensor housing and auto configuration will take place
- All Sentro sensing modules have two output alarm signals for General alarm and High alarm. Default values are entered during manufacture and these can be changed to preferred values
- The two alarm signals can be set to illuminate built-in flashing LED indicators
- The two alarm signals can be set to operate the General alarm and High alarm relays on the Dual Relay Contact version of the Sentro.

## 2. Certification

### 2.1 Australia

Ex certified for use in underground mines: TX6356.06.xx

Ex Certificate Number: IECEx ITA 14.0006X  
Ex ia I Ma (-20°C ≤ Ta ≤ + 40°C)



### Conditions of Safe Use

The following safety parameters are applicable to the Sentro 1 TX6356 Humidity Sensor/Transmitter.

### Input Parameters

Model	Field Screw	Ui	Ii	Ci	Li	Pi
	Terminals					
TX6356.06.01 (4 to 20 mA)	5 WRT 6	14.4 V	* 1	0	0	-
	1 WRT (2 or 3)	-	-	-	-	-
TX6356.06.02 (0.4 to 2 V)	5 WRT 6	14.4 V	* 1	0	0	-
	1 WRT (2 or 3)	-	-	-	-	-
TX6356.06.03 (5 to 15 Hz)	5 WRT 6	14.4 V	* 1	0	0	-
	1 WRT 2	16.5 V	-	0	0	2.5 W
TX6356.06.04 (RS485)	5 WRT 6	14.4 V	* 1	0	0	-
	1 WRT 2	6.88 V	* 1	0	0	-
	2 WRT 3					
TX6356.06.05 (dual relay normally closed)	5 WRT 6	14.4 V	* 1	0	0	-
	1 WRT 2	30 V	* 1	0	0	-
	3 WRT 4	30 V	* 1	0	0	-
TX6356.06.06 (dual relay normally open)	5 WRT 6	14.4 V	* 1	0	0	-
	1 WRT 2	30 V	* 1	0	0	-
	3 WRT 4	30 V	* 1	0	0	-

## Output Parameters

Model	Field Screw	U <sub>o</sub>	I <sub>o</sub>	P <sub>o</sub>	C <sub>o</sub>	L <sub>o</sub> * 2
	Terminals					
TX6356.06.01 (4 to 20 mA)	5 WRT 6	-	-	-	-	-
	1 WRT (2 or 3)	14.4 V	477 mA	1.72 W	* 3	2.1 mH
TX6356.06.02 (0.4 to 2 V)	5 WRT 6	-	-	-	-	-
	1 WRT (2 or 3)	14.4 V	40 mA	135 mW	* 3	292 mH
TX6356.06.03 (5 to 15 Hz)	5 WRT 6	-	-	-	-	-
	1 WRT 2	0	0	0	0	0
TX6356.06.04 (RS485)	5 WRT 6	-	-	-	-	-
	1 WRT 2	5.88 V	66 mA	97 mW	* 3	26 mH
	2 WRT 3					
TX6356.06.05 (dual relay normally closed)	5 WRT 6	-	-	-	-	-
	1 WRT 2	0	0	0	0	0
	3 WRT 4	0	0	0	0	0
TX6356.06.06 (dual relay normally open)	5 WRT 6	-	-	-	-	-
	1 WRT 2	0	0	0	0	0
	3 WRT 4	0	0	0	0	0

\* 1 I<sub>i</sub> Not critical

\* 2 L<sub>o</sub> I<sub>s</sub> calculated using the formula  $\frac{1}{2}L_o (I_o * 1.5)^2 = 525 \mu J$ .

\* 3 C<sub>o</sub> C<sub>o</sub> = 1  $\mu F$ , unless the conditions stated in 60079-11 2011, Clause 10.1.5.2 part b can be satisfied.

WRT With Respect To

## 2.2 Europe (ATEX)

Ex certified for use in underground mines: TX6356.01.xx

Ex Certificate Number: Sira 16ATEX2048

Ex Certification Marking: Ex ia I Ma (Ta=-20°C to +40°C)

### General Conditions for Safe Use

Prior to installation, it is essential that user refers to the above certificate to ensure that the termination and cable parameters are fully complied with and are compatible with the application copies of certificates are available from Trolex.

## 3. Installation

### 3.1 Safety Precautions

#### **Hazardous areas**

Do not disassemble the humidity sensor whilst in the hazardous area or use a sensor that has a damaged housing in the hazardous area.

### 3.2. Tools and Test Equipment Required

No special tools are needed.

### 3.3. Siting Recommendations

#### **Location of Humidity Sensors**

Each installation needs to be considered in its own right, with reference to safety authorities and in compliance with mandatory local safety regulations. The sensor must be operated in accordance with the User Manual to maintain safety, reliability and to preserve safety integrity where applicable.

It is important that sensors are located in positions determined in consultation with those who have specialised knowledge of the plant or installation and of the principles of humidity. Reference should also be made to those responsible for the engineering layout and topology of the plant as they will be most familiar with the nature of the potential dangers and the most likely sources of high humidity.

Sensor coverage cannot be simply expressed in terms of 'number per unit area'. Sensors need to be sited where they are capable of monitoring those parts of a plant where humidity may accumulate or where a source of humidity is expected to occur. This way, the earliest possible warning of humidity can be given to initiate shutdown functions, alarm functions or safe evacuation of the premises.

#### **Sensor Management**

A very important part of an efficient humidity monitoring system is the training of plant personnel in operation and maintenance of the sensors and the complete monitoring system. Training can be provided by qualified Trolex application engineers.

Once a sensor installation is complete, the sensor locations and types should be formally recorded and a planned test and maintenance procedure instituted.

### 3.4 Connections

#### 3.4.1 0.4 to 2 V Analogue Output Signal

The output signal from terminals 1 and 2 is a low impedance two-wire voltage output. Can be configured as 3 or 4 wire.

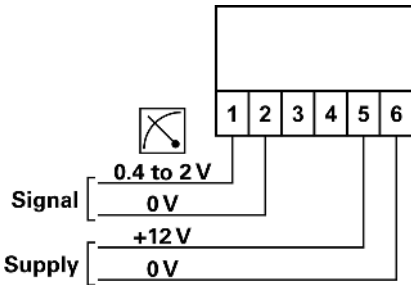
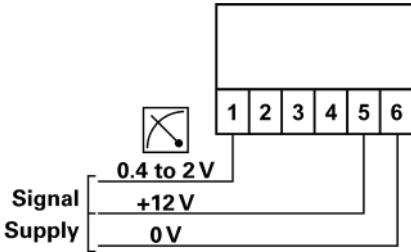

#### 3.4.2 4 to 20 mA Analogue Output Signal

The output signal from terminals 1 and 2 is a conventional 4 to 20 mA two wire current regulated signal loop. Can be configured as 3 or 4 wire.

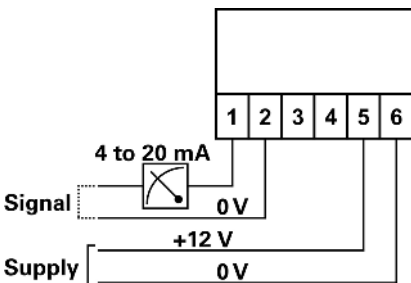
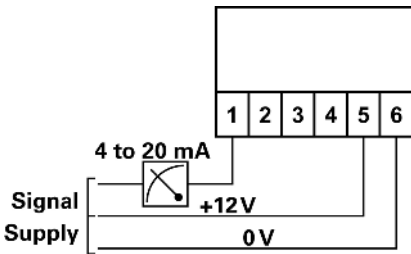

### 3.4.3 5 to 15 Hz Output Signal

A square wave, frequency variable output that is proportional to the measured value.

A pull up resistor may be required at the monitoring device.

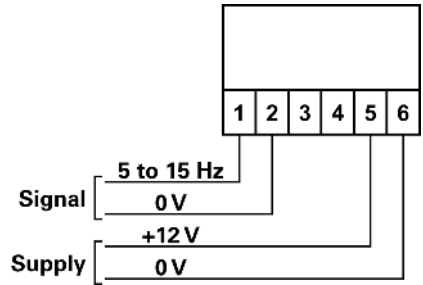
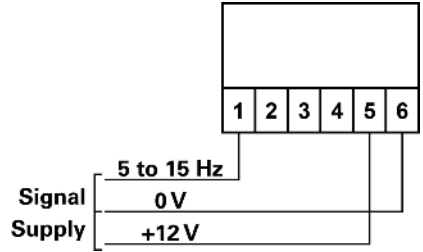

### 3.4.4 Dual Relay Contact

Dual independent relay contacts for remote signalling and control. Setpoint values for General and High alarms may be adjusted to preference.

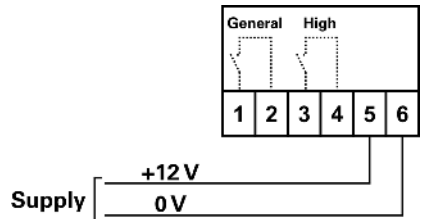

### 3.4.5 RS485 Data Output Signal

RS485 serial data output with analogue signal intelligence.

Use in conjunction with a PC for data display and setpoint alarm warnings.

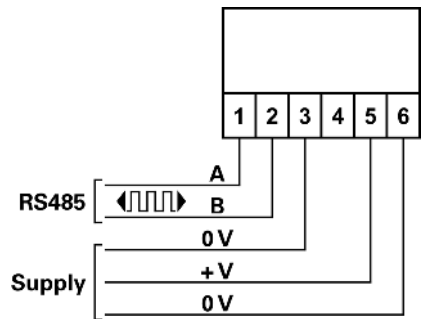

## 32 node RS485 (MODBUS)



Up to 32 sensors acting as slaves can communicate with the master unit on a single data cable.

The address code of the sensor is marked on the duty label of the sensor.

<b>Physical layer:</b>	RS485
<b>Protocol:</b>	Troxel proprietary
<b>Connection mode:</b>	Modbus
<b>Number of points:</b>	32
<b>Maximum distance:</b>	1,000 m

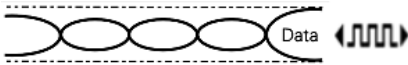

Recommended cable (specified in BS5308 Part 1) for locally powered sensors:

- 1 twisted pair
- 0.5 mm<sup>2</sup>
- Overall screen

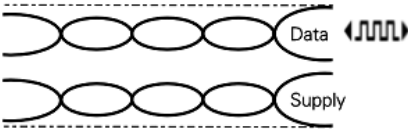

Recommended cable for sensors that are powered through the data cable:

- 2 twisted pair
- 0.5 mm<sup>2</sup>
- Individual/overall screen

## 4. Setup and Calibration

### 4.1 Controls and Indicators

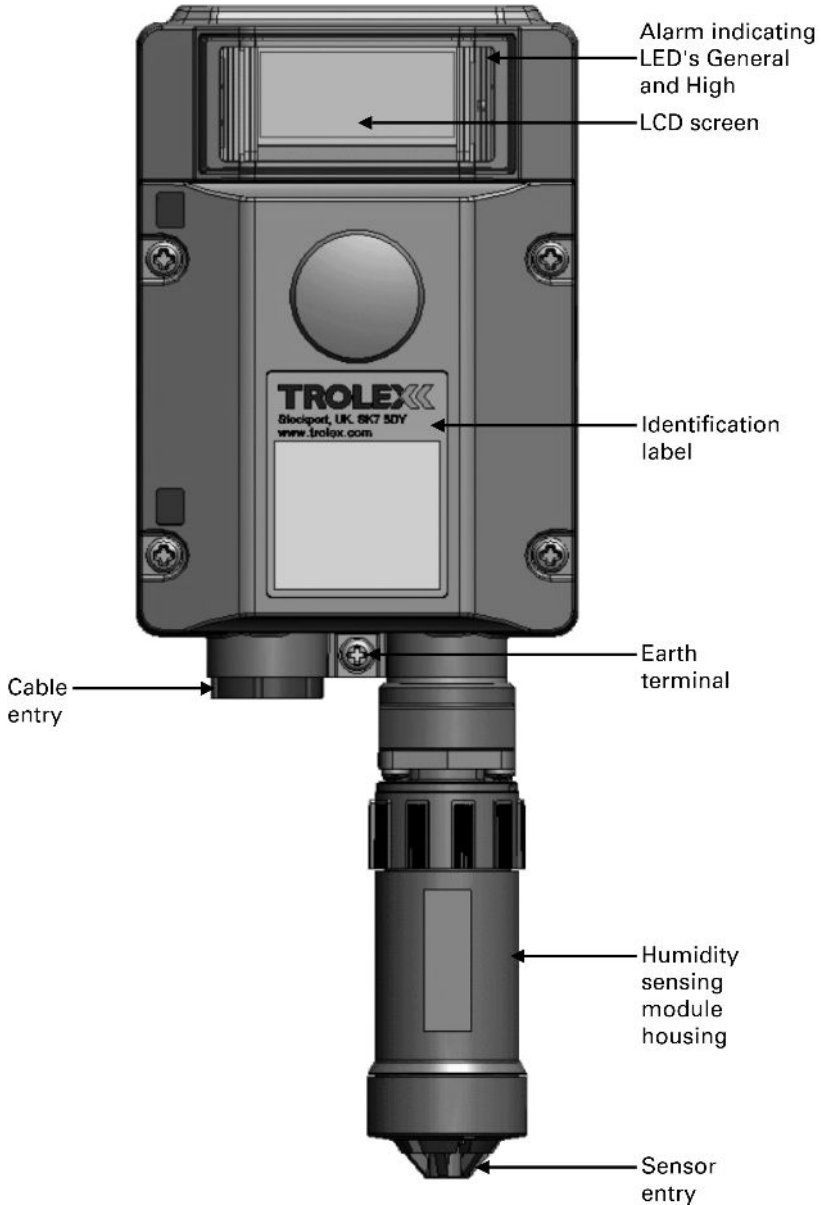



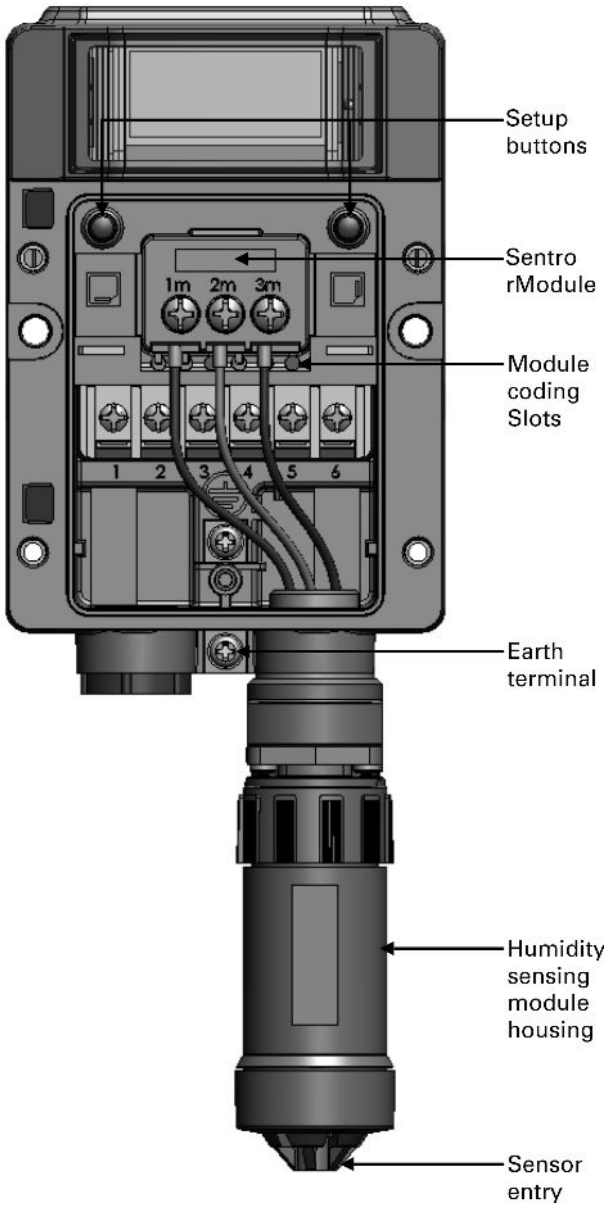

## 4.2 Software Menus

[Start-up Screen - Pg 20](#)

[Main Display - Pg 20](#)

[Main Menu - Pg 21](#)

[Sentro Setup - Pg 22](#)

[System Information - Pg 22](#)

[Display Setup - Pg 23](#)

[Set Backlight - Pg 23](#)

[Adjust Contrast - Pg 24](#)

[Exit - Pg 24](#)

[Alert Setup - Pg 24](#)

[Visual Alert - Pg 25](#)

[Confidence Alarm - Pg 25](#)

[Exit - Pg 26](#)

[Set Security Code - Pg 26](#)

[Exit - Pg 26](#)

[Output Setup - Pg 27](#)

[0.4 to 2 V Analogue Output Signal - Pg 27](#)

[Output Information - Pg 28](#)

[Trim Output Zero - Pg 28](#)

[Trim Output Span - Pg 29](#)

[Reset Output - Pg 29](#)

[Exit - Pg 30](#)

[4 to 20 mA Analogue Output Signal - Pg 30](#)

[Output Information - Pg 30](#)

[Trim Output Zero - Pg 30](#)

[Trim Output Span - Pg 31](#)

[Reset Output - Pg 32](#)

[Exit - Pg 32](#)

[5 to 15 Hz Analogue Output Signal - Pg 32](#)

[Output Information - Pg 33](#)

[Trim Output Zero - Pg 33](#)

[Trim Output Span - Pg 34](#)

[Reset Output - Pg 34](#)

[Exit - Pg 35](#)

[Dual Relay Contact - Pg 35](#)

[Set Relay 1 Mode - Pg 35](#)

[Set Relay 2 Mode - Pg 35](#)

[Exit - Pg 36](#)

[RS485 Data Output Signal - Pg 36](#)

[Modbus Address - Pg 36](#)

[Baud Rate - Pg 37](#)

[TxOn Delay - Pg 37](#)

[TxOff Delay - Pg 37](#)

[Exit - Pg 38](#)

[Module Setup - Pg 38](#)

[Scaling - Pg 39](#)

[Lower Range - Pg 39](#)

[Upper Range - Pg 39](#)

[Exit - Pg 40](#)

[Setpoint 1 - Pg 40](#)

[Activation - Pg 41](#)

[Level - Pg 41](#)

[Exit - Pg 42](#)

[Setpoint 2 - Pg 40](#)

[Activation - Pg 41](#)

[Level - Pg 41](#)

[Exit - Pg 42](#)

[Configuration - Pg 42](#)

[Set DutyText - Pg 43](#)

[Set Update - Pg 44](#)

[Exit - Pg 45](#)

[Exit - Pg 45](#)

[Exit - Pg 45](#)

### 4.3 Navigation

**NEXT****SELECT/CHANGE****Checkpoint**

To use the **Sentro Humidity Sensor** software and navigate between menus you must press the Setup Buttons:

**Next** is the Left button - **L**

**Select/Change** is the Right button - **R**.

The use of these buttons is abbreviated to **L** and **R** throughout this User Manual.

To access the **L (Next)** and **R (Select/Change)** buttons you need to remove the front cover. Use a cross head screwdriver to remove the four screws securing the front cover and move it out of the way.

**Checkpoint**

The **Sentro Humidity Sensor** is factory configured with the Security Code unset. If a **Security Code** has been subsequently set it will need to be successfully entered before the menus can be accessed.

## 4.4 Power-up

When the **Sentro Humidity Sensor** is powered-up the **Start-up Screen** will appear. The **Start-up Screen** displays basic information about the system including the software version, driver version and output type.

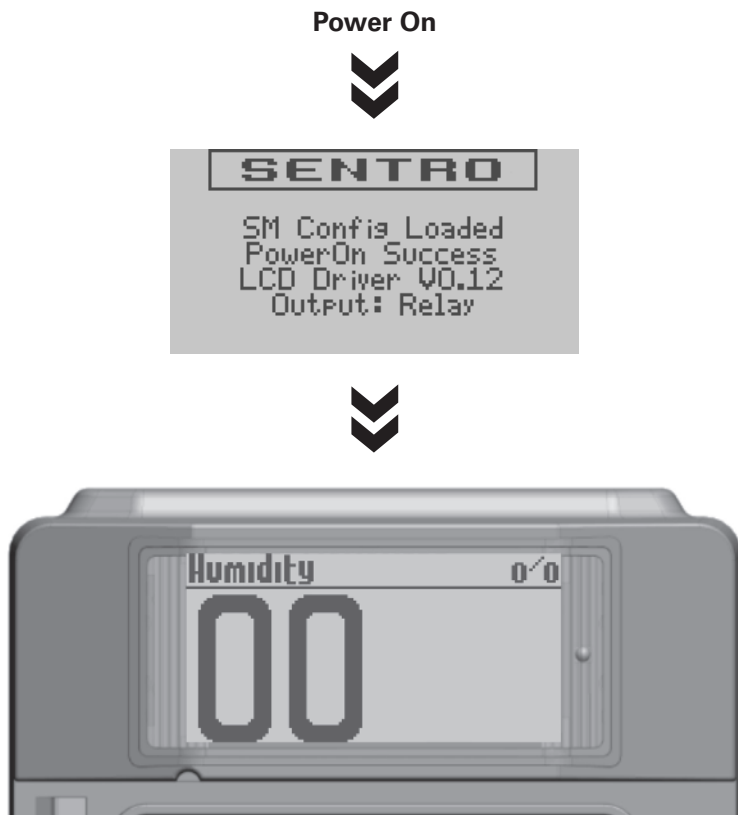

After five seconds the **Main Display** will appear. The **Main Display** displays the current humidity level.

## 4.5 Main Menu

From the **Main Display** press and hold **L**, this will bring up the **Main Menu**.

From the **Main Menu** the operating parameters of the **Sentro Humidity Sensor** may be set up according to preference. The available menus are as follows:

- **Sentro Setup**
- **Output Setup**
- **Module Setup**
- **Exit**

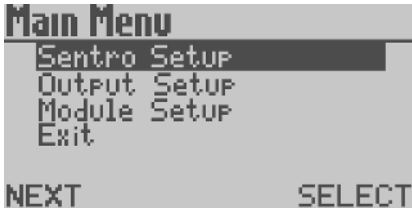

### Checkpoint

You can safely remove the front cover of the **Sentro Humidity Sensor** for setup in a hazardous area, even with the power applied.

### Checkpoint

The **Sentro Humidity Sensor** will automatically return to the **Main Display** if no keys are pressed within 30 seconds.

## 4.5.1 Sentro Setup

This enables you to view and carry-out setup of the **Sentro Humidity Sensor** characteristics.

From the **Main Menu** press **L**, navigate to **Sentro Setup** and press **R** to enter the **Sentro Setup Menu**.

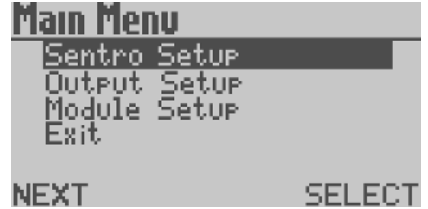

The available menus are as follows:

- **System Information**
- **Display Setup**
- **Alert Setup**
- **Set Security Code**
- **Exit**



### 4.5.1.1 System Information

This displays basic information about the system including the main software version, system date, system time, driver versions and output formats.



From the **Sentro Setup Menu** press **L**, navigate to the **System Information** and press **R** to display the **System Information**.

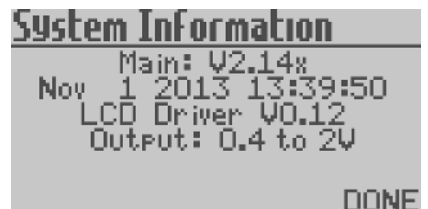



## 4.5.1.2 Display Setup Menu

This enables you to carry-out the setup of the **Display**.

From the **Sentro Setup Menu** press **L**, navigate to the **Display Setup** and press **R** to enter the **Display Setup Menu**.

The available menus are as follows:

- **Set Backlight**
- **Adjust Contrast**
- **Exit**

### Set Backlight

The screen backlight illumination may be set to **On** or **Off**, to reduce power consumption.

From the **Display Setup Menu** press **L**, navigate to **Set Backlight** and press **R** to enter the **Set Backlight Menu**.

From the **Set Backlight Menu** press **R** to set the Backlight Illumination to **On** or **Off** as required.

Press **L** to move to **Save** or **Cancel** as required. Press **R** to confirm the selection and return to the **Display Setup Menu**.



## Adjust Contrast

The contrast of the screen may be set for best visual appearance.

From the **Display Setup Menu** press **L**, navigate to **Adjust Contrast** and press **R** to enter the **Adjust Contrast Menu**.

Press **L** to navigate to **Increase** or **Decrease** as required. Press **R** to **Increase** or **Decrease** the contrast as required.

Press **L** and select **Save** or **Cancel** as required. Press **R** to confirm the selection and return to the **Display Setup Menu**.

## Exit

From the **Display Setup Menu** press **L**, navigate to **Exit**, press **R** to confirm the selection and return to the **Sentro Setup Menu**.

### 4.5.1.3 Alert Setup Menu

This enables you to carry-out the setup of the **Alerts**.

From the **Sentro Setup Menu** press **L**, navigate to **Alert Setup** and press **R** to enter the **Alert Setup Menu**.

The available menus are as follows:

- **Visual Alert**
- **Confidence Alarm**
- **Exit**

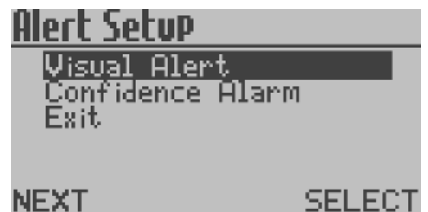



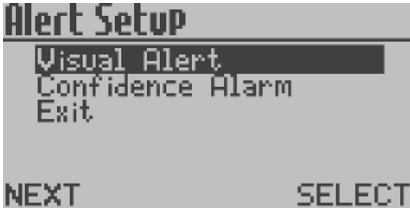

## Visual Alert

The integral **General** and **High** visual alarms can be set to **On** or **Off**.

From the **Alert Setup Menu** press **L**, navigate to **Visual Alert** and press **R** to enter the **Visual Alert Menu**.

From the **Visual Alert Menu** press **R** to set the **Visual Alert** to **On** or **Off** as required.

Press **L** and navigate to **Save** or **Cancel** as required. Press **R** to confirm the selection and return to the **Alert Setup Menu**.

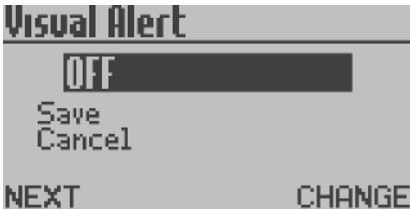

## Confidence Alarm

The **Confidence Alarm** flash can be set to **On** or **Off**. For details of the **Confidence Alarm** refer to **Section 5**.

From the **Alert Setup Menu** press **L**, navigate to **Confidence Alarm** and press **R** to enter the **Confidence Alarm Menu**.

From the **Confidence Alarm Menu** press **R** to set the **Confidence Alert** to **On** or **Off** as required.

Press **L** to move to **Save** or **Cancel** as required.

Press **R** to confirm the selection and return to the **Alert Setup Menu**.

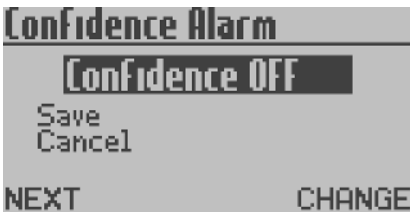

## Exit

From the **Alert Setup Menu** press **L**, navigate to **Exit** and press **R** to confirm the selection and return to the **Sentro Setup Menu**.

### 4.5.1.4 Set Security Code

This enables you to enter a **Security Code** and prevent unauthorised access to the **Main Menu**.

From the **Sentro Setup Menu** press **L**, navigate to **Set Security Code** and press **R** to enter the **Set Security Code** menu.

From **Set Security Code** press **R** to increment the first digit. Press **L** to confirm the selection and move to the next digit.

Repeat for all four digits. Press **L** and navigate to **Save** or **Cancel** as required and Press **R** to confirm the selection.

### 4.5.1.5 Exit

From the **Sentro Setup Menu** press **L**, navigate to **Exit**, press **R** to confirm the selection and return to the **Main Menu**.

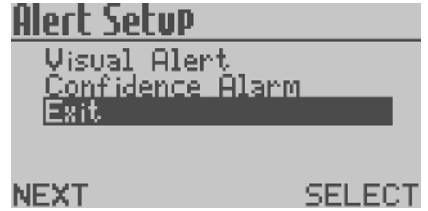

## 4.5.2 Output Setup

This enables you to view information on and setup characteristics of the **Sentro Humidity Sensor** output signal.

### Checkpoint

The output signal type of the **Sentro Humidity Sensor** is configured during manufacture. The output signal will be one of five types:

- 0.4 to 2 V analogue output signal
- 4 to 20 mA analogue output signal
- 5 to 15 Hz output
- Dual relay contacts
- RS485 digital output signal

Each of the five signal types has a unique set of menus that enable you to view and configure characteristics of the output signal. All five sets of menus are described in the following sections.

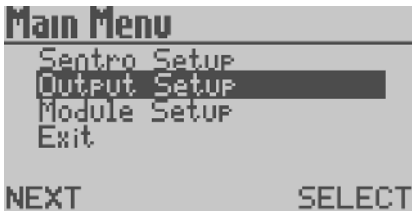

From the **Main Menu** press **L**, navigate to **Output Setup** and press **R** to enter the **Output Setup Menu**.

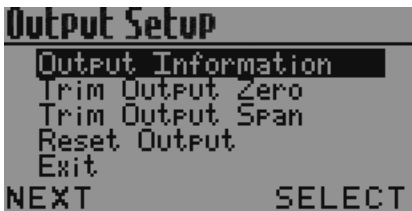

### 4.5.2.1 0.4 to 2V Analogue Output Signal

The available menus are as follows:

- **Output Information**
- **Trim Output Zero**
- **Trim Output Span**
- **Reset Output**
- **Exit**

## Output Information

This displays the factory set output signal type for the **Sentro Humidity Sensor**.

From the **Output Setup Menu** press **L**, navigate to **Output Information** and press **R** to display the **Output Information**.

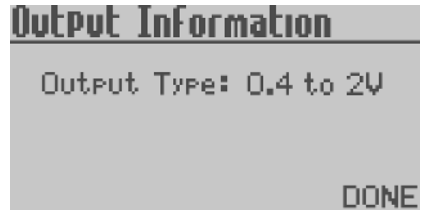
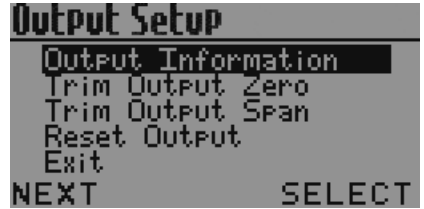

## Trim Output Zero

The level of the transmitted output signal, when the **Sentro Humidity Sensor** is measuring zero humidity can be trimmed or offset.

From the **Output Setup Menu** press **L**, navigate to **Trim Output Zero** and press **R** to enter the **Trim Output Zero Menu**.

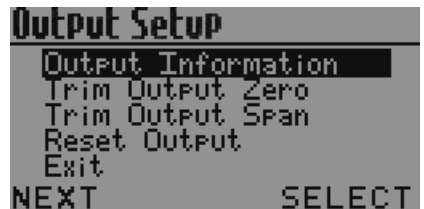

Press **L** to navigate to **Increase** or **Decrease** as required. Press **R** to **Increase** or **Decrease** the **Output Zero** as required.

Press **L** and select **Save** or **Cancel** as required. Press **R** to confirm the selection and return to the **Output Setup Menu**.

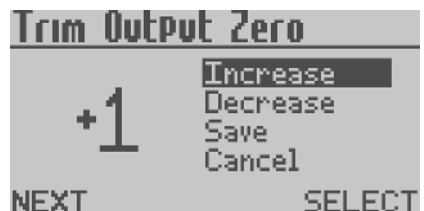

## Trim Output Span

The level of the transmitted output signal, when the **Sentro Humidity Sensor** is measuring a given humidity level can be trimmed or offset.

From the **Output Setup Menu** press **L**, navigate to **Trim Output Span** and press **R** to enter the **Trim Output Span Menu**.



Press **L** to navigate to **Increase** or **Decrease** as required. Press **R** to **Increase** or **Decrease** the **Output Span** as required.

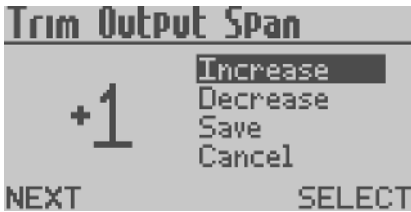

Press **L** and select **Save** or **Cancel** as required. Press **R** to confirm the selection and return to the **Output Setup Menu**.

## Reset Output

This enables you to reset the **Zero** and **Span** output signal levels back to the default factory settings.

From the **Output Setup Menu** press **L**, navigate to **Reset Output** and press **R** to enter the **Reset Output** menu.

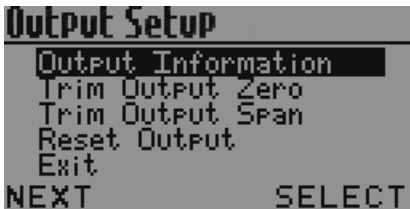

Press **L** to navigate to **Restore Defaults** and press **R** to confirm the selection.

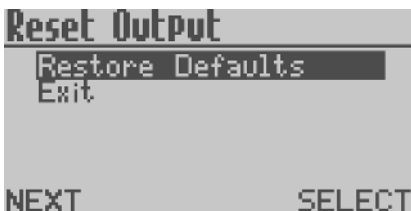

## Exit

From the **Output Setup Menu** press **L**, navigate to **Exit**, press **R** to confirm the selection and return to the **Main Menu**.

### 4.5.2.2 4 to 20 mA Analogue Output Signal

The available menus are as follows:

- **Output Information**
- **Trim Output Zero**
- **Trim Output Span**
- **Reset Output**
- **Exit**

## Output Information

This displays the factory set output signal type for the **Sentro Humidity Sensor**.

From the **Output Setup Menu** press **L**, navigate to **Output Information** and press **R** to display the **Output Information**.

## Trim Output Zero

The level of the transmitted output signal, when the **Sentro Humidity Sensor** is measuring zero humidity can be trimmed or offset.

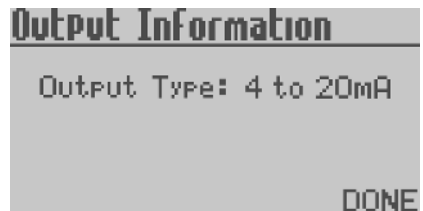
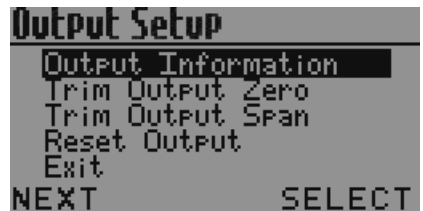
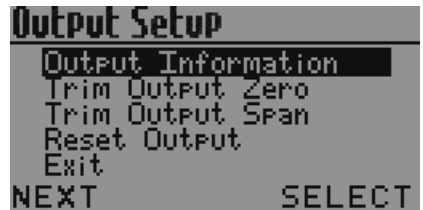
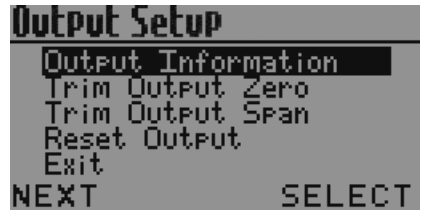

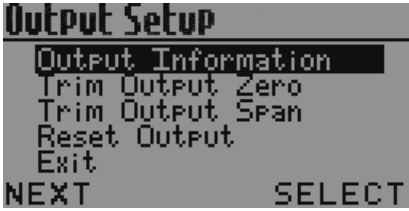

From the **Output Setup Menu** press **L**, navigate to **Trim Output Zero** and press **R** to enter the **Trim Output Zero Menu**.

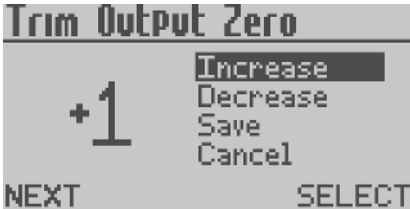

Press **L** to navigate to **Increase** or **Decrease** as required. Press **R** to **Increase** or **Decrease** the **Output Zero** as required.

Press **L** and select **Save** or **Cancel** as required. Press **R** to confirm the selection and return to the **Output Setup Menu**.

## Trim Output Span

The level of the transmitted output signal, when the **Sentro Humidity Sensor** is measuring a given humidity level can be trimmed or offset.



From the **Output Setup Menu** press **L**, navigate to **Trim Output Span** and press **R** to enter the **Trim Output Span Menu**.

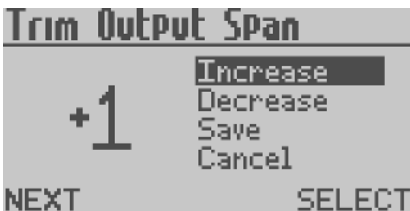

Press **L** to navigate to **Increase** or **Decrease** as required. Press **R** to **Increase** or **Decrease** the **Output Span** as required.

Press **L** and select **Save** or **Cancel** as required. Press **R** to confirm the selection and return to the **Output Setup Menu**.

## Reset Output

This enables you to reset the **Zero** and **Span** output signal levels back to the default factory settings.

From the **Output Setup Menu** press **L**, navigate to **Reset Output** and press **R** to enter the **Reset Output** menu.

Press **L** to navigate to **Restore Defaults** and press **R** to confirm the selection.

## Exit

From the **Output Setup Menu** press **L**, navigate to **Exit**, press **R** to confirm the selection and return to the **Main Menu**.

### 4.5.2.3 5 to 15 Hz Output Signal

The available menus are:

- **Output Information**
- **Trim Output Zero**
- **Trim Output Span**
- **Reset Output**
- **Exit**

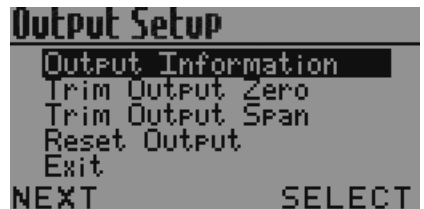
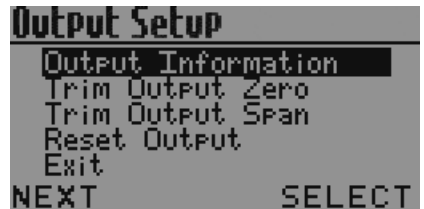
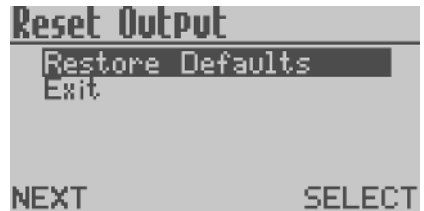
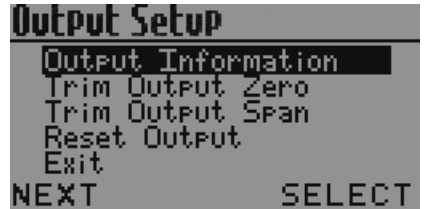



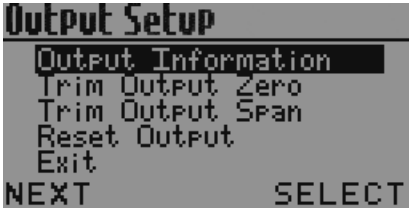

## Output Information

This displays the factory set output signal type for the **Sentro Humidity Sensor**.

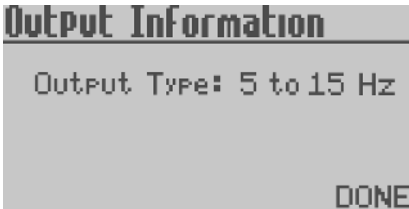

From the **Output Setup Menu** press **L** to navigate to **Output Information**. Press **R** to display the **Output Information**.

## Trim Output Zero

The level of the transmitted output signal, when the **Sentro Humidity Sensor** is measuring zero humidity can be trimmed or offset.

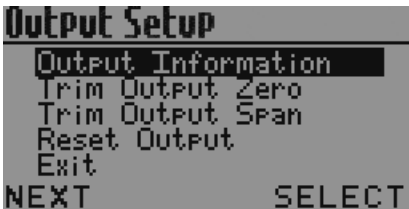

From the **Output Setup Menu** press **L** to navigate to **Trim Output Zero**. Press **R** to enter the **Trim Output Zero** Menu.

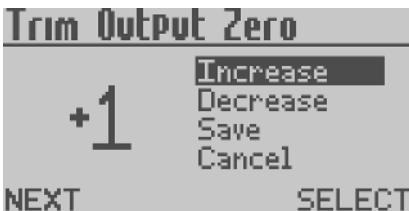

Press **L** to navigate to **Increase** or **Decrease** as required. Press **R** to **Increase** or **Decrease** the **Output Zero** as required.

Press **L** to navigate to **Save** or **Cancel** as required. Press **R** to confirm the selection and return to the **Output Setup Menu**.

## Trim Output Span

The level of the transmitted output signal, when the **Sentro Humidity Sensor** is measuring a given humidity level can be trimmed or offset.

From the **Output Setup Menu** press **L**, navigate to **Trim Output Span** and press **R** to enter the **Trim Output Span Menu**.

Press **L** to navigate to **Increase** or **Decrease** as required. Press **R** to **Increase** or **Decrease** the **Output Span** as required.

Press **L** and select **Save** or **Cancel** as required. Press **R** to confirm the selection and return to the **Output Setup Menu**.

## Reset Output

This enables you to reset the **Zero** and **Span** output signal levels back to the default factory settings.

From the **Output Setup Menu** press **L**, navigate to **Reset Output** and press **R** to enter the **Reset Output** menu.

Press **L** to navigate to **Restore Defaults** and press **R** to confirm the selection.

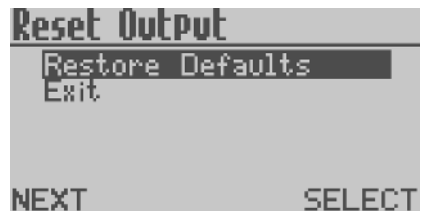
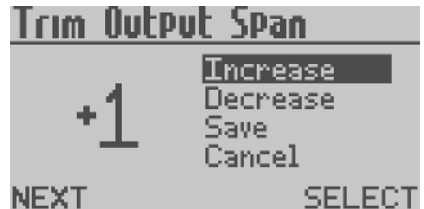

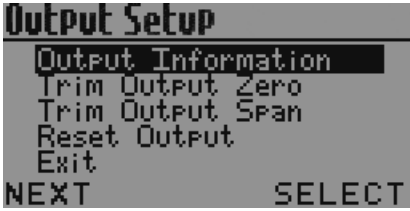

## Exit

From the **Output Setup Menu** press **L**, navigate to **Exit**, press **R** to confirm the selection and return to the **Main Menu**.



## 4.5.2.4 Dual Relay Contact

The available menus are as follows:

- **Set Relay 1 Mode**
- **Set Relay 2 Mode**
- **Exit**

## Set Relay 1 Mode and Set Relay 2 Mode

This enables you to setup the operating function of each relay. Each Relay can be independently setup.

### Checkpoint

**Set Relay 1 Mode** and **Set Relay 2 Mode** are configured in exactly the same way as each other.

### Checkpoint

A relay can be configured to **Latch** or **Automatically Reset** according to preference.



From the **Output Setup Menu** press **L**, navigate to **Set Relay 1 Mode** or **Set Relay 2 Mode** and press **R** to enter **Set Relay 1 Mode** or **Set Relay 2 Mode**.

Press **R** to change from **Latch** and **Auto**. Press **L** and select **Save** or **Cancel** as required. Press **R** to confirm the selection and return to the **Output Setup Menu**.

### Checkpoint

A relay configured to **Latch** cannot be reset until the initiating signal has receded.

### Exit

From **Set Relay 1 Mode** or **Set Relay 2 Mode** press **L**, navigate to **Exit** and press **R** to confirm the selection and return to the **Output Setup Menu**.

### 4.5.2.5 RS485 Data Output Signal

The available menus are as follows:

- **Modbus Address**
- **Baud Rate**
- **TxOn Delay**
- **TxOff Delay**
- **Exit**

### Modbus Address

The **Modbus Address** can be set between **1** and **255** as required.

From the **Output Setup Menu** press **L**, navigate to **Modbus Address** and press **R** to enter the **Modbus Address Menu**.

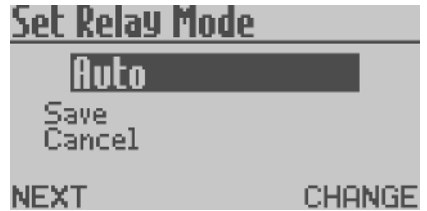

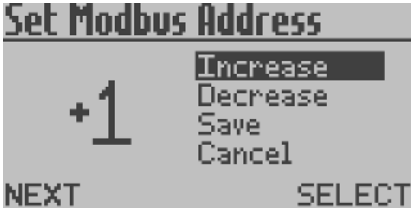

Press **L** to navigate to **Increase** or **Decrease** as required. Press **R** to **Increase** or **Decrease** the **Modbus Address** as required.

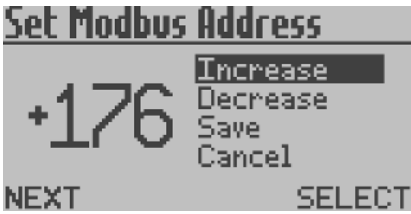

Press **L** and navigate to select **Save** or **Cancel** as required. Press **R** to confirm the selection and return to the **Output Setup Menu**.

## Baud Rate

The Baud Rate can be set to 300/600/1200/2400/4800/9600/14400/19200/28800/38400/57600/115200 as required.



From the **Output Setup Menu** press **L**, navigate to **Baud Rate** and press **R** to enter the **Set Baud Rate Menu**.

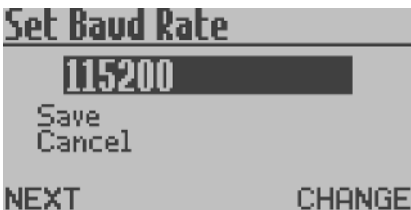

Press **R** to navigate to the required **Baud Rate**, press **L** and select **Save** or **Cancel** as required. Press **R** to confirm the selection and return to the **Output Setup Menu**.

## TxOn Delay and TxOff Delay

### Checkpoint

**TxOn Delay** and **TxOff Delay** are configured in exactly the same way as each other.

The **TxOn Delay** and **TxOff Delay** can be set between 0 and 99 ms.

From the **Output Setup Menu** press **L**, navigate to **TxOn Delay** or **TxOff Delay** as required and Press **R** to enter the **TxOn Delay** or **TxOff Delay Menu** as required.

Press **L** to navigate to **Increase** or **Decrease** as required. Press **R** to **Increase** or **Decrease** as required. Press **L** and select **Save** or **Cancel** as required. Press **R** to confirm the selection and return to the **Output Setup Menu**.

### Exit

From the **Output Setup Menu** press **L**, navigate to **Exit**, press **R** to confirm the selection and return to the **Main Menu**.

## 4.5.3 Module Setup

This enables you to setup the functional values of the **Sentro Module** fitted to **Sentro Humidity Sensor**.

From the **Main Menu** press **L**, navigate to **Module Setup** and press **R** to enter the **Module Setup Menu**.

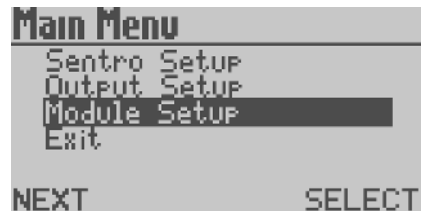
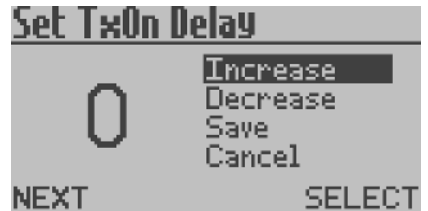

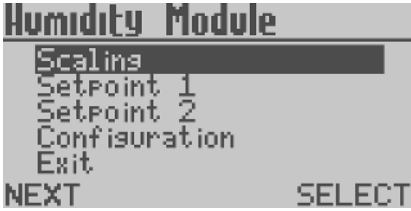

The available menus are as follows:

- **Scalings**
- **Setpoint 1**
- **Setpoint 2**
- **Configuration**
- **Exit**

### 4.5.3.1 Scalings

This enables you to carry-out a setup of the **Scalings** functions.

From the **Module Setup Menu** press **L**, navigate to **Scalings** and press **R** to enter the **Scalings Setup Menu**.

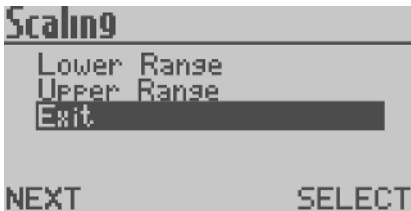

The available menus are as follows:

- **Lower Range**
- **Upper Range**
- **Exit**

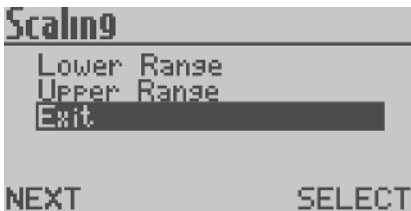

### Lower Range and Upper Range

Set the desired **Lower Range** and **Upper Range** of the displayed reading for a given magnitude of input signal. This can be any numeric value and the polarity can be any negative value through to any positive value.

From the **Scalings Setup Menu** press **L**, navigate to **Lower Range** or **Upper Range** as required and press **R** to enter the **Lower Range** or **Upper Range Menu** as required.

Press **R** to change the minus to a plus.  
Press **L** to move to the first digit, press **R** to increment the digit and press **L** to move to the next digit.

Press **L** and select **Save** or **Cancel** as required. Press **R** to confirm the selection and return to the **Scaling Setup Menu**.

## Exit

From the **Scaling Setup Menu** press **L**, navigate to **Exit** and press **R** to **Exit** the **Scaling Setup Menu** and return to the **Module Setup Menu**.

### 4.5.3.2 Setpoint 1 and Setpoint 2

This enables you to carry-out a setup of **Setpoint 1** and **Setpoint 2**.

#### Checkpoint

**Setpoint 1** and **Setpoint 2** are configured in exactly the same way.

From the **Module Setup Menu** press **L**, navigate to **Setpoint 1** or **Setpoint 2** and press **R** to enter the **Setpoint 1** or **Setpoint 2 Setup Menu**.

The available menus are as follows:

- **Activation**
- **Level**
- **Exit**

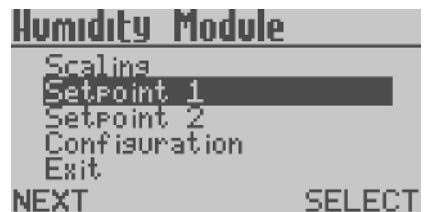
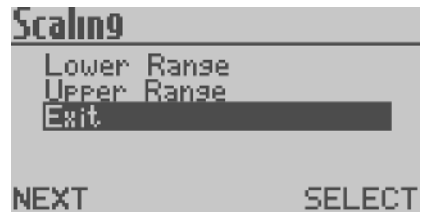
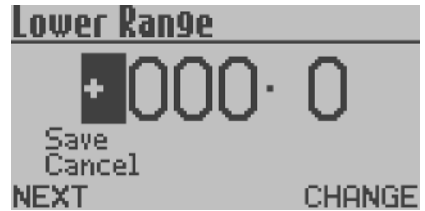



## Activation

The **Activation** mode of **Setpoint 1** and **Setpoint 2** can be configured to **Over** or **Under** as required.

From the **Setpoint 1** or **Setpoint 2 Setup Menu** press **L**, navigate to **Activation** and press **R**.



From the **Activation Menu** press **R** to set **Activation** to **Over** or **Under** as required.

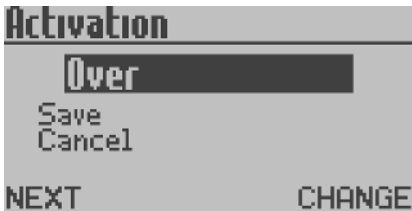

Press **L** and navigate to **Save** or **Cancel** as required. Press **R** to confirm the selection and return to the **Setpoint 1** or **Setpoint 2 Setup Menu**.

## Level

The **Level** at which **Setpoint 1** and **Setpoint 2** are activated can be configured.

### Checkpoint

The default setting for **Setpoint 1** is 40% and for **Setpoint 2** is 65%.

From the **Setpoint 1** or **Setpoint 2 Setup Menu** press **L**, navigate to **Level** and press **R**.



Press **R** to increment the digits as required.  
Press **L** to move to the next digit. Repeat for all digits and press **L**.

Press **L** and select **Save** or **Cancel** as required. Press **R** to confirm the selection and return to the **Setpoint 1** or **Setpoint 2 Setup Menu**.

## Exit

From the **Setpoint 1** or **Setpoint 2 Setup Menu** press **L**, navigate to **Exit**, press **R** to confirm the selection and return to the **Module Setup Menu**.

### 4.5.3.3 Configuration

This enables you to setup the **Configuration** of the sensing module.

From the **Module Setup Menu** press **L**, navigate to **Configuration** and press **R** to enter the **Configuration Setup Menu**.

The available menus are as follows:

- **Set Duty Text**
- **Set Update**
- **Exit**

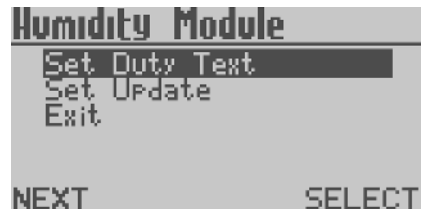
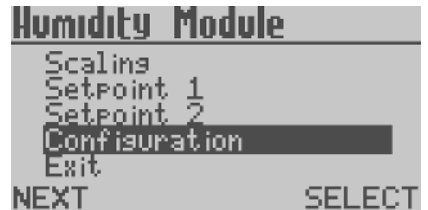
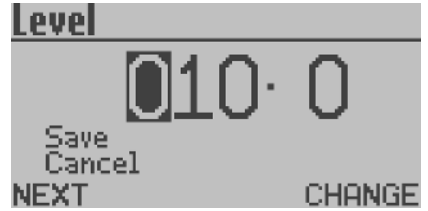

## Set Duty Text

The **Duty Text** can be set according to preference, by default it reads **Humidity**.

From the **Configuration Setup Menu** press **L**, navigate to **Set Duty Text** and press **R** to enter the **Set Duty Text Menu**.

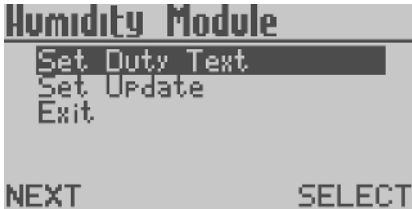

From the **Set Duty Text Menu** press **R** to increment a character as required and press **L** to move to the next character.

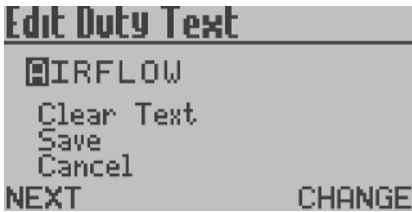

### Checkpoint

The characters are in the sequence **A** to **Z**, **0** to **9** and a **Blank Space**.

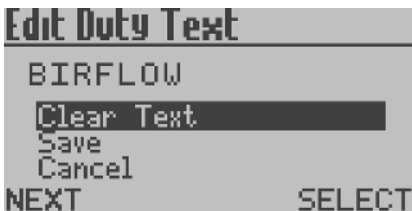

### Checkpoint

If you wish to clear all text press **L**, navigate to **Clear Text** and press **R** to clear all **Duty Text** as required.

### Checkpoint

The maximum number of characters that can be entered in the **Duty Text** field is 16.

Press **L** and select **Save** or **Cancel** as required. Press **R** to confirm the selection and return to the **Configuration Setup Menu**.

## Set Update

The value of the analogue input signal is averaged and up-dated at periodic intervals. You can configure the up-date period in the **Set Update Menu**.

### Checkpoint

A low **Set Update** setting will give rapid reaction to the input signal and a higher setting may be entered where damping of a fluctuating input is necessary, or simply as a means of applying a delay to the input. This is particularly useful in electrically noisy environments.

From the **Configuration Setup Menu** press **L**, navigate to **Set Update** and press **R** to enter the **Set Update Menu**.

Press **L** to navigate to **Increase** or **Decrease** as required. The field is configurable between 0 and 99 seconds.

Press **R** to **Increase** or **Decrease** as required. Press **L** and select **Save** or **Cancel** as required. Press **R** to confirm the selection and return to the **Configuration Setup Menu**.

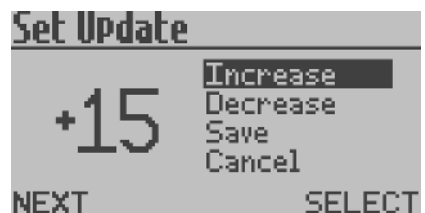
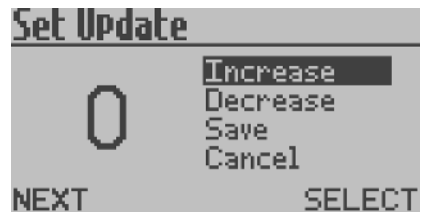

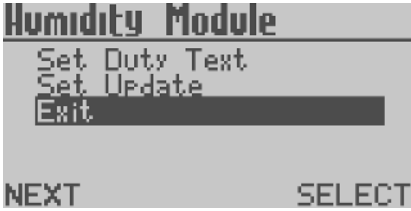

## Exit

From the **Configuration Setup Menu** press **L** and navigate to **Exit**. Press **R** to confirm the selection and return to the **Module Setup Menu**.

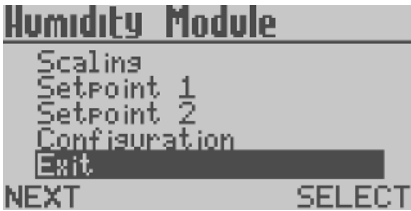

## 4.5.3.4 Exit

From the **Module Setup Menu** press **L**, navigate to **Exit** and press **R** to confirm the selection and return to the **Main Menu**.



## 4.5.4 Exit

From the **Main Menu** press **L**, navigate to **Exit** and press **R** to confirm the selection and return to the **Main Display**.

## 4.6 Support

If you need technical support to operate this product, or would like details of our after sales technical support packages, please contact your local Trolex service agent or [service@trolex.com](mailto:service@trolex.com).

## 5. Operation

In normal operation the **Sentro Humidity Sensor** will display the humidity on the LCD screen, this is the **Main Display**. If the **Confidence Alert** has been enabled it will flash every 15 seconds.



### 5.1 Dual Relay Contact Output Signal

On the Dual Relay Contact version of the **Sentro Humidity Sensor** the functional mode and status of the relays can be displayed at any time. Press **L** and the relay state will be displayed.



#### 5.1.1 To Reset a Latched Relay

If a relay is latched during operation, reset it as follows. From the **Main Display** press **R** to open the **Unlatch Relays** menu.

The available menus are as follows:

- **Unlatch Relay 1**
- **Unlatch Relay 2**
- **Go to Main Menu**
- **Exit**



#### 5.1.1.1 Unlatch Relay 1 and Unlatch Relay 2

##### Checkpoint

**Relay 1** and **Relay 2** are unlatched in exactly the same way.

## Checkpoint

A relay configured to **Latch** cannot be reset until the initiating signal has receded.



From the **Unlatch Relays Menu** press **L**, navigate to **Unlatch Relay 1** or **Unlatch Relay 2** and press **R**.



Press **L** to navigate to **Unlatch Relay 1** or **Unlatch Relay 2** and press **R** to confirm the selection.



### 5.1.1.2 Go to Main Menu

From the **Unlatch Relays Menu** press **L**, navigate to **Go to Main Menu**, press **R** and return to the **Main Menu**.



### 5.1.1.3 Exit

From the **Unlatch Relays Menu** press **L**, navigate to **Exit**, press **R** and return to the **Main Display**.

## Checkpoint

A relay configured to **Latch** cannot be reset until the initiating signal has receded.

## 6. Diagnostics and Maintenance

### 6.1 Diagnostic Messages

#### Sensor Over-range

If the **Sentro Humidity Sensor** goes over-range then the following message will be seen on the LCD screen.

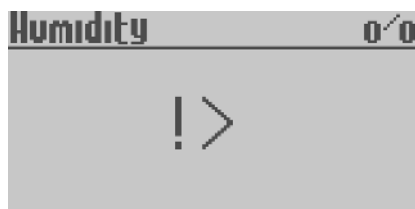

#### Loss of Signal From the Sensor

If there is a loss of signal from the sensing module to the **Sentro Humidity Sensor** an error message will be shown.

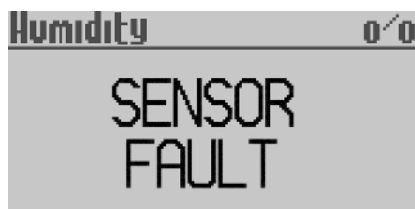

#### Module Not Fitted

If the sensing module has been removed from the **Sentro Humidity Sensor** and is out for more than 10 seconds, an error message will be shown.

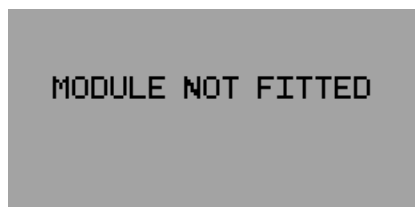

### 6.2 Maintenance

#### 6.2.1 Introduction

To keep your **Sentro Humidity Sensor** in the best possible condition and minimise downtime, Trolex strongly recommends that you carry out regular planned preventative maintenance and keep records of the maintenance carried out. The planned preventative maintenance for **Sentro Humidity Sensor** consists of a number of tasks carried out at regular intervals on a



cumulative basis, ie. at 12 months do the 1 month task, the 3 month task, the 6 month task AND the 12 month task. These tasks are listed in the maintenance schedule below:

Equipment Name	Task Type	Task Number	Interval
Sentro Humidity Sensor	Check	6.2.2	1 month
Sentro Humidity Sensor	Clean	6.2.3	3 months
Sentro Humidity Sensor Output Signal	Check	6.2.4	6 months
Sentro Humidity Sensor	Function Test	6.2.5	12 months



## 6.2.2 Sentro Humidity Sensor - Check

1. Check the exterior of the **Sentro Humidity Sensor** for cracks, penetration, water ingress and other signs of damage.
2. Check that the front cover is free from damage and is securely fitted.
3. Check the LCD screen is clear and free from damage.
4. If any part of the **Sentro Humidity Sensor** shows any signs of damage, deformation or missing parts, contact your local Trolex service agent or **service@trolex.com** for advice on repair or replacement.
5. After the completion of all maintenance, update the maintenance records.

## 6.2.3 Sentro Humidity Sensor - Clean

1. Examine the sensor housing and assess its condition.
2. Clean the sensor head with a soft brush or cloth if necessary.

### Checkpoint

Do not use sharp tools as this may cause damage to the humidity sensor.

3. After the completion of all maintenance, update the maintenance records.



## 6.2.4 Sentro Humidity Sensor Output Signal - Check

1. Using a test meter check that the value of the output signal agrees with the value of the display reading.
2. After the completion of all maintenance, update the maintenance records.





## 6.2.5 Sentro Humidity Sensor - Function Test

1. Under normal circumstances, the calibration of the humidity sensor will not change significantly.
2. Check the accuracy by comparing the display reading with a reference value of humidity.

OR

2. Alternatively, the **Sentro Humidity Sensor** can be removed and returned to your local Trolex service agent, for checking and calibration across the full operating spectrum. Contact **service@trolex.com** for further information.
3. After the completion of all maintenance, update the maintenance records.

## 6.3 Disposal

Part of the ethos of Trolex is sustainable design. The **Sentro Humidity Sensor** contains materials that can be recovered, recycled and reused. At the end of its useful life ensure that the **Sentro Humidity Sensor** is recycled in accordance with local laws and bylaws for the geographic area where it is located. The end of its useful life is to be determined by the owner/operator of the equipment and not Trolex. Ensure that the **Sentro Humidity Sensor** is recycled by licenced waste contractors with the appropriate licences for handling metal, plastic and electronic waste in the geographic area where the **Sentro Humidity Sensor** is located.

## 6.4 Maintenance Records

Implement a planned preventative maintenance process and keep good maintenance records.

Consult your local Trolex service agent or the Trolex Product Support Department: **service@trolex.com** for help in implementing a planned preventative maintenance process.

The 'Maintenance Log' gives an example of a typical maintenance record system.



## Disclaimers

The information provided in this document contains general descriptions and technical characteristics of the performance of the product. It is not intended as a substitute for and is not to be used for determining suitability or reliability of this product for specific user applications. It is the duty of any user or installer to perform the appropriate and complete risk analysis, evaluation and testing of the products with respect to the relevant specific application or use. Trolex shall not be responsible or liable for misuse of the information contained herein. If you have any suggestions for improvements or amendments, or find errors in this publication, please notify us at [marketing@trolex.com](mailto:marketing@trolex.com).

No part of this document may be reproduced in any form or by any means, electronic or mechanical, including photocopying, without express written permission of Trolex.

All pertinent state, regional, and local safety regulations must be observed when installing and using this product. For reasons of safety and to help ensure compliance with documented system data, only Trolex or its affiliates should perform repairs to components.

When devices are used for applications with technical safety requirements, the relevant instructions must be followed.

## Trademarks

© 2015 Trolex® Limited.

Trolex is a registered trademark of Trolex Limited. The use of all trademarks in this document is acknowledged.

## Document History

Issue 01    24 February 2015    Original publication of this document - 4th draft

## Contact Details

Trolex Ltd, Newby Road, Hazel Grove, Stockport, Cheshire, SK7 5DY, UK  
+44 (0) 161 483 1435    [sales@trolex.com](mailto:sales@trolex.com)



**TROLEX**«

**Trolex Ltd.** Newby Road, Hazel Grove, Stockport, Cheshire SK7 5DY, UK  
**t:** +44 (0)161 483 1435 **e:** sales@trolex.com [www.trolex.com](http://www.trolex.com)