

TX6373 TOXIC GAS SENSOR/TRANSMITTER



ANZEx



PETROCHEMICAL
PROCESSING

MINING &
TUNNELLING

OFFSHORE
PLATFORMS

MANUFACTURING
& PROCESS
PLANTS

STORAGE AREAS &
WAREHOUSING

WATER
MANAGEMENT
& SEWAGE
TREATMENT

POWER GENERATION

GAS STORAGE &
DISTRIBUTION

TELECOMMS



INSTALLATION & OPERATING DATA

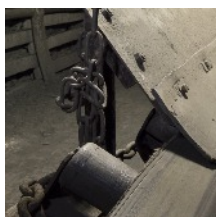
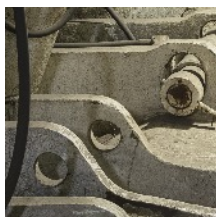

contents...

	page
1 PRINCIPAL OPERATING FEATURES	2
2 APPLICATION	3
3 DIMENSIONS AND MOUNTING	4
4 TECHNICAL DETAILS	4
5 INSTALLATION	6
6 CONNECTIONS	10
7 CONTROLS AND INDICATORS	13
8 CALIBRATION	14
9 MAINTENANCE	17
10 APPROVALS AND CERTIFICATION	20
11 FUNCTIONAL SAFETY	22

INSTALLATION & OPERATING DATA

1 PRINCIPAL OPERATING FEATURES



ANZEx

EAC



Stationary gas sensors for the detection of a wide range of toxic gases.

Suitable for use in SIL 1 and SIL 2 applications, in accordance with any conditions or restrictions.



High accuracy electrochemical sensing elements.

Pre-calibrated plug-in gas sensing module with a standardised output signal for convenient replacement and servicing.

Calibration available for a wide range of toxic gases.



Convenient push button calibration of ZERO and SPAN.

Signal fix during calibration to prevent false alarms - 4 wire systems only

Output signal versions:- 4 to 20 mA, 0.4 to 2 V & 5 to 15 Hz



Anti-static polycarbonate/ABS housing.

Intrinsically safe for use in Group I and Group II hazardous areas.

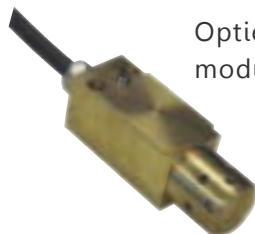

Optional format with remote mounted gas sensing module in robust metal housing.

2 APPLICATION



Fixed gas monitoring for point-source hazards and perimeter protection in arduous duty and exposed locations. Safety protection for toxic gas risk occurring in hazardous areas and general industrial applications.

Petrochemical processing.

Mining and tunnelling.

Offshore platforms.

Manufacturing and process plants.

Storage areas and warehousing.

Water management and sewage treatment.

Power generation.

Gas storage and distribution.

Telecommunications.

A choice of output signals for direct interfacing with most standard industrial monitoring systems.

A range of primary instrumentation and monitoring modules is available from Trolex to which the sensors can be directly connected to provide a flexible choice of display and control functions.



TRIP AMPLIFIER

for use with analogue output sensors.

CONFIGURABLE SENSOR CONTROLLER

for monitoring up to 8 analogue output sensors.



COMMANDER DISTRIBUTED I/O SYSTEM

for large scale general plant monitoring systems and the mining and tunnelling industries.



ANZEx



3 DIMENSIONS

3.1 TX6373 Toxic Gas Sensor/Transmitter 3.2 TX6373.84 Toxic Gas Sensor/Transmitter with Remote Gas Sensing Module

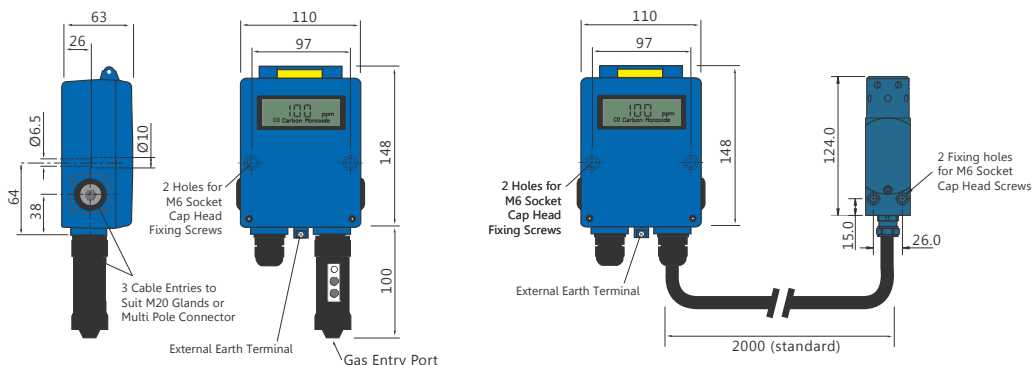

ALL DIMENSIONS IN MM

4 TECHNICAL DETAILS

4.1 Specification

Ambient Temperature Limits:	-10°C to +50°C
Storage Temperature Limits:	-20°C to +60°C
Ambient Pressure Limits:	Atmospheric ± 10%
Humidity:	90% RH non-condensing
Protection Classification:	Dust and waterproof to IP66. Gas inlet port to IP54
Housing Material:	Anti-static polycarbonate/ABS
Nett Weight:	450 g
Cable Entries:	M20 x 1.5
Electrical Connections:	4 mm Barrier/clamp terminals
Information Display:	Graphic LCD
Impact Limits:	20 joules (Housing)
Calibration:	Digitally controlled ZERO and SPAN. Push button setting
Signal Fix:	The transmitted output signal of the sensor is FIXED at 00.0 during calibration to prevent false alarms from being initiated

METHANE CATALYTIC COMBUSTION

ELECTROCHEMICAL SENSOR	SENSING RANGE	LINEARITY	DRIFT	REPEATABILITY	RESPONSE TIME T63%	OPERATING LIFE*	ORDER REF
Carbon Monoxide	0 to 50 ppm 0 to 250 ppm 0 to 500 ppm	±2% FS	2% month	±2%	9 secs	> 2 years	(250.50) (250.250) (250.500)
Hydrogen Sulphide	0 to 50 ppm	±2%	2% month	±2%	14 secs	> 2 years	(251)
Sulphur Dioxide	0 to 20 ppm	±2%	2% month	±2%	7 secs	> 2 years	(252)
Nitrogen Dioxide	0 to 20 ppm	±2%	2% month	±2%	15 secs	> 2 years	(254)
Chlorine	0 to 10 ppm	±2%	2% month	±2%	37 secs	> 2 years	(255)
Oxygen	0 to 25%	±5%	10% year	±2%	5 secs	> 1 year	(257)
Nitric Oxide	0 to 100 ppm	±5%	2% month	±2%	9 secs	> 2 years	(259)
Hydrogen	0 to 1000 ppm	±1%	2% month	±2%	13 secs	> 2 years	(261)

*IN CLEAN AIR



ANZEx



4 TECHNICAL DETAILS *continued*

4.2 Electrical Details

TX6373.01 GROUP I APPLICATIONS (12 V dc)

Output:	0.4 to 2 V dc	
Min Load	10 k ohms	
Supply	6.5 to 16.5 V dc	
Max Current	<10 mA	

Output:	4 to 20 mA	
Max Load	275 ohms @ 12 V	
Supply	6.5 to 16.5 V dc	
Max Current	24 mA	

Output:	5 to 15 Hz	
Max Load	Opto isolated 2 mA max	
Supply	6.5 to 16.5 V dc	
Max Current	<20 mA	

TX6373.02 GROUP II APPLICATIONS (24 V dc)

When used in conjunction with safety barriers. (Section 6)

Refer to Section 6

Output:	4 to 20 mA	
Max Load	875 ohms @ 24 V dc	
Supply	6.5 to 30 V dc	
Max Current	24 mA	

TX6373.03 GENERAL PURPOSE APPLICATIONS (24 V dc)

NOT SUITABLE FOR USE IN CLASSIFIED HAZARDOUS AREAS

Output:	4 to 20 mA	
Max Load	875 ohms @ 24 V dc	
Supply	6.5 to 30 V dc	
Nominal Current	24 mA	



INSTALLATION & OPERATING DATA

5 INSTALLATION

5.1 Conformity Check



ANZEx

EAC



(Refer to Test Certificate provided with the sensor).

Does the output signal of the sensor concur with the input requirement of the monitoring equipment being used?

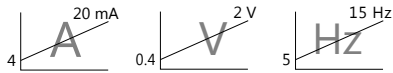

12 V dc

24 V dc

Is the correct supply voltage available for the sensor?

Is the type of gas and its anticipated maximum level of concentration, within the operating parameters of the sensor?

Is the temperature variation range, at the installation, within the stated temperature range of the sensor?



Is the hazardous area classification correct?

If the hazard is Group II – are the correct safety barriers fitted?

GENERAL PURPOSE

GROUP I

GROUP II

STANDARD OPTIONS AVAILABLE



TX6373.01	TOXIC GAS SENSOR/ TRANSMITTER	GROUP I
TX6373.02	TOXIC GAS SENSOR/ TRANSMITTER	GROUP II
TX6373.03	TOXIC GAS SENSOR/ TRANSMITTER	GENERAL PURPOSE



TX6373.84.01	TOXIC GAS SENSOR/ TRANSMITTER with Remote Gas Sensing Module	GROUP I
TX6373.84.02	TOXIC GAS SENSOR/ TRANSMITTER with Remote Gas Sensing Module	GROUP II



TX6373.84.03	TOXIC GAS SENSOR/ TRANSMITTER with Remote Gas Sensing Module	GENERAL PURPOSE
--------------	--	-----------------

TYPE OF GAS

Refer to Section 4.2

OUTPUT SIGNAL	0.4 to 2 V	(11)
	4 to 20 mA	(12)
	5 to 15 Hz output	(13)

5 INSTALLATION continued

5.2 Location

Each installation needs to be considered in its own right, with reference to safety authorities and in compliance with mandatory local safety regulations. The sensor must be operated in accordance with the Installation and Operating Data to maintain safety, reliability and to preserve Intrinsic Safety integrity where applicable.

It is important that sensors are located in positions determined in consultation with those who have specialised knowledge of the plant or installation and of the principles of gas dispersion. Reference should also be made to those responsible for the engineering layout and topology of the plant as they will be most familiar with the nature of the potential dangers and the most likely sources of gas release.

It is also important to recognise that the characteristics of the gas source can be influenced by many factors; including the relative density or buoyancy of the gas, the pressure at the point of release, the ambient temperature and the ventilation of the site.

Sensor coverage cannot be simply expressed in terms of 'number per unit area'. Sensors need to be sited where they are capable of monitoring those parts of a plant where gas may accumulate or when a source of gas release is expected to occur. This way the earliest possible warning of a gas release can be given to initiate shutdown functions, alarm functions or safe evacuation of the premises.

5.3 System Integrity

If a gas monitoring system should fail for any reason, it is important that the system is capable of immediately alerting operational staff to this fact. The sensor will indicate a system failure or mechanical defect and this information can be utilised to initiate a warning alarm. It is good practice to provide emergency facilities to protect against the loss of the mains power supply.

Standby batteries can be incorporated with automatic changeover facilities, so guaranteeing continued operation of the gas sensing system even in the event of a plant breakdown as a result of a power supply failure.

Certainly, in critical plants, duplication or triplication of sensors is recommended.

The Trolex TX9042 or TX9044 Programmable Sensor Controller can be programmed to operate with sensors in the multiple voting mode.



5.4 Sensor Management

A very important part of an efficient gas monitoring system is the training of plant personnel in operation and maintenance of the sensors and the complete monitoring system. Training facilities can be provided by qualified Trolex application engineers.

Once a sensor installation is complete, the sensor locations and types should be formally recorded and a planned test and maintenance procedure instituted.



ANZEx



5 INSTALLATION *continued*

5.5 Relative Density



The relative density or buoyancy of the gas or vapour with respect to air is a very important consideration. This determines its propensity to rise or fall when released into the atmosphere.

Gases or vapours with a buoyancy less than air will tend to rise from the source of release.

Conversely, gases or vapours heavier than air will tend to fall and accumulate in concentrations for long periods of time.

This is a particular problem in pits, trenches, machine rooms, etc. Normal air movements in and around such gas concentrations will have the inevitable effect of producing zones of highly toxic mixtures.

This knowledge of the characteristics of the gas assists when positioning the gas sensor.

The behaviour of the gas accumulation will also be affected by the velocity and location of the gas release and by ambient air movement caused by ventilation systems or draughts.

Pockets of gas can be trapped in trenches or ceiling cavities, all of which adds to the unpredictability of critical gas concentrations.

Hydrogen	LIGHTER THAN AIR
Carbon Monoxide	
Nitric Oxide	HEAVIER THAN AIR
Oxygen	
Sulphur Dioxide	
Chlorine	
Nitrogen Dioxide	

5.6 Hazardous Areas

Do not disassemble the sensor whilst in the hazardous area or use a sensor that has a damaged housing in the hazardous area.

5.7 Evacuation

If a dangerous level of gas concentration is detected by the instrument, leave the area immediately.



5 INSTALLATION *continued*

5.8 Operating Life

Electrochemical cells contain an electrolyte that is gradually consumed during use. The average life is about two years, dependent upon the duty cycle. The response should be checked at regular intervals.

5.9 Sensitivity

Electrochemical cells for toxic gases can be affected by other interfering gases which may displace the subject gas being monitored. Steam laden atmospheres and condensation can also reduce the sensitivity.

5.10 Flammable

Be aware that some toxic gases are also 'flammable' at high percentage concentrations.

5.11 Biased Sensors

Some gas sensors must be continuously powered to maintain the calibration.

If the gas head is removed from any supply voltage for greater than 10 minutes, it could take 24–48 hours to restore its calibration.



ANZEx

EAC



6 CONNECTIONS



ANZEx



OUTPUT SIGNAL OPTIONS

TX6373 TOXIC GAS SENSOR/ TRANSMITTER
2 - WIRE CURRENT LOOP OPERATION

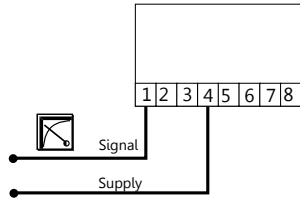

TX6373 TOXIC GAS SENSOR/ TRANSMITTER
4 - WIRE OPERATION

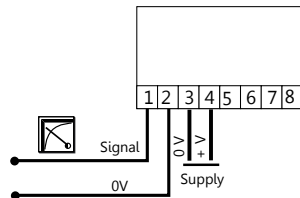

6.1 0.4 to 2 V Output Signal

A low impedance two-wire voltage output signal requiring a separate power supply to the sensor.

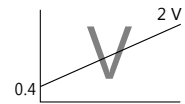

This can be derived from a TX9132

Trip Amplifier or TX9042 Programmable Sensor Controller, when one of those is used as the monitoring instrument.

This connection configuration works well up to about 2000 metres distance between the sensor and the monitoring equipment.

Both the signal and the power supply to the sensor are being carried in the common 0 V conductor so at some point – influenced by the length of the cable and the resistance of the cable cores – the current flowing in the 0 V conductor will impose an unacceptable voltage error onto the signal.

This effect can be reduced on long distance connections by increasing the size of the cable cores, or even better, running a separate 0 V conductor to power the sensor enabling operating distances up to 5000 metres.

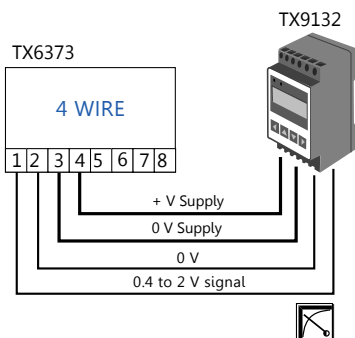
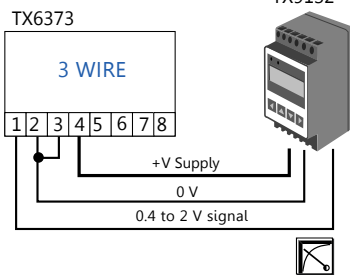

APPLICATION

GROUP I HAZARDOUS AREAS

6 CONNECTIONS continued



ANZEx

EAC



6.2 4 to 20 mA Output Signal

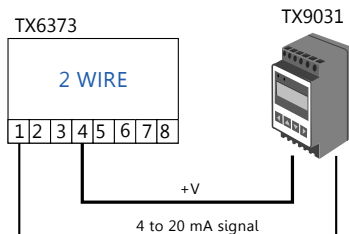

The output signal from terminals 1 and 4 is a conventional 4 to 20 mA two wire current regulated signal loop. Electrochemical sensors have very low power consumption so the same loop can be used to also power the sensor.

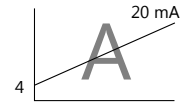

No separate power supply is needed.

APPLICATION

**GROUP I HAZARDOUS AREAS
GROUP II HAZARDOUS AREAS
GENERAL PURPOSE**

6.3 5 to 15 Hz Output Signal

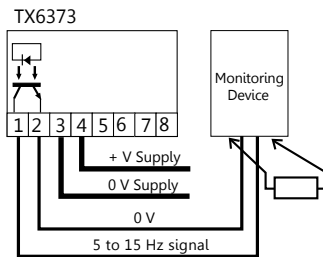

A pull up resistor may be required at the monitoring device.

A square wave, frequency variable output that is proportional to the measured value. The output device is an open collector NPN transistor.

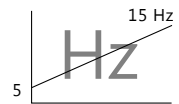

Output:	5 to 15 Hz (zero = 5 Hz) (span = 15 Hz)
Maximum Voltage:	15.4 V
Maximum Current:	2 mA
Minimum Pulse Rise Time:	5 V/ms

APPLICATION

GROUP I HAZARDOUS AREAS

6.4 Using Gas Sensors in Hazardous Areas

6.4.1

GROUP I HAZARDOUS AREAS (MINING)

TX6373.01 TOXIC GAS SENSOR/ TRANSMITTER

All options of the TX6373.01 sensor (0.4 to 2 V, 4 to 20 mA and 5 to 15 Hz) are certified Intrinsically Safe for use in Group I hazardous areas (Mining) when used with approved equipment eg. TX9131 Trip Amplifier or a TX9042 Programmable Sensor Controller.

THE COMPLETE SYSTEM, BOTH SENSOR AND MONITORING DEVICE, CAN BE MOUNTED IN THE HAZARDOUS AREA.

The interconnecting cable between the sensor and the monitoring device must have steel wire armoured protection or a braided earth screen. The cross sectional area of the conductors must be a minimum of 1 mm².

SAFE

HAZARDOUS



6 CONNECTIONS continued

6.4.2

GROUP II HAZARDOUS AREAS (24 V dc)

TX6373.02 TOXIC GAS SENSOR/ TRANSMITTER

This version of the sensor (4 to 20 mA) is certified Intrinsically Safe for use in Group II hazardous areas, when used in conjunction with safety barriers.

THE SAFETY BARRIERS ARE MOUNTED IN THE SAFE AREA, ONLY THE SENSOR IS MOUNTED IN THE HAZARDOUS AREA. The system may be used with either zener safety barriers or isolation safety barriers.

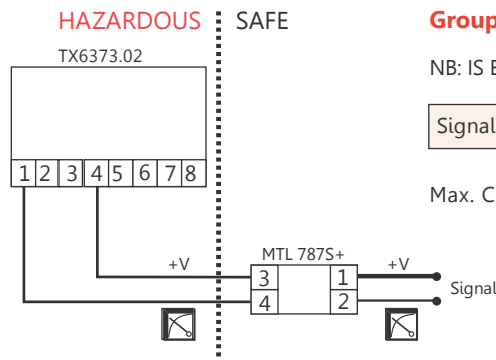
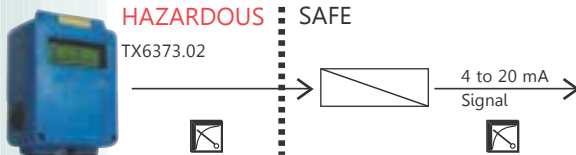

Group II sensor connections using zener safety barriers.

NB: IS EARTH MUST BE LESS THAN 10 OHMS LOOP RESISTANCE

Signal Safety Barrier: MTL787S+

Max. Cable Length: 1 km using 1.5 mm² cable conductors.

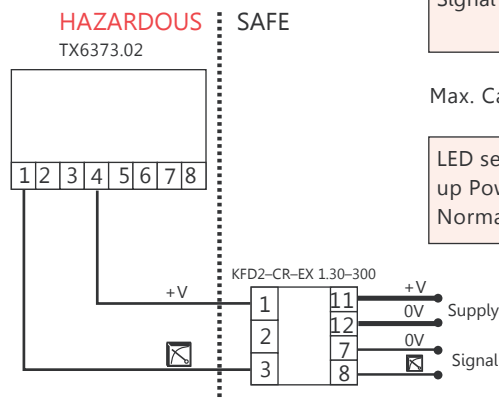

Group II sensor connections using isolation safety barriers.

Signal Isolation Barrier: Pepperl & Fuchs
KFD2-CR-EX 1.30-300

Max. Cable Length: 1 km using 1.5 mm² cable conductors.

LED sequence on power-up
Power up: Red LED flashes 3 times
Normal Operation: No LEDs illuminated

If you require any help with the use and connection of hazardous area equipment please contact the Trolex Technical Department.









ANZEx

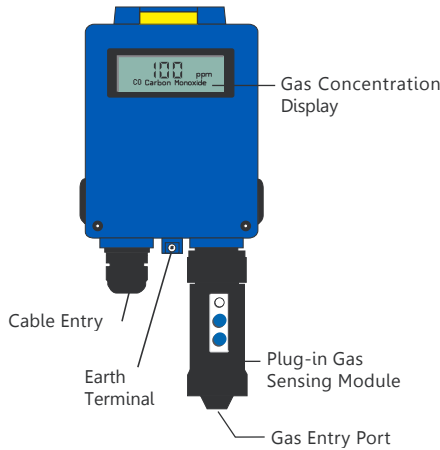

7 CONTROLS AND INDICATORS

TX6373 TOXIC GAS SENSOR/ TRANSMITTER



-  Calibration STATUS indicator 
-  SPAN calibrate pushbutton 
-  ZERO calibrate pushbutton 

TX6373.84 TOXIC GAS SENSOR/ TRANSMITTER REMOTE GAS SENSING MODULE.

This version uses the same pre-calibrated gas sensing module as the TX6373. The module is fitted into a robust metal housing which can be mounted at a remote location where space is constricted or the operating conditions are extremely harsh.

Connections:	2 metres, flexible cable in a flexible armoured conduit (other lengths available to specification - max. of 10 m)
Protection Classification:	Dust and waterproof to IP66
Housing Material:	Brass or Stainless steel
Maximum Cable Length:	Extendible up to 250 m using 1.5 mm ² cable conductors



CHECK POINT DISCONNECTING THE REMOTE GAS SENSING MODULE

The connecting cable between the remote gas sensing module and the Transmitter is normally supplied connected at both ends. The cable can be disconnected via a plug and socket connector inside the Transmitter housing for servicing or transportation.

The Ribbon Cable Assembly must lie flat against the inside rear of the enclosure & must be connected to the feed through in the orientation shown.

IMPORTANT!

Double line indicates red marker on ribbon cable.



View showing orientation of ribbon cable. (All other parts removed for clarity).

Secure connector to inside of the enclosure with a double sided adhesive foam pad. (Trim off any excess before fitting).

8 CALIBRATION



The gas sensing module will gradually change its response characteristics, by a small amount, during normal use. The output signal is standardised so the module can be quickly changed when necessary.

Service replacement modules can be supplied by our Product Support Department.

Alternatively the gas sensing module may be re-calibrated when required, using a Trolex TX6520 Gas Test Kit equipped with both Air and

Test Gas canisters.



ANZEx



8.1 Prepare to Calibrate

Connect the application tube of the gas test kit to the inlet aperture of the gas sensing module.

8.2 Enter Calibrate Mode



Press BOTH pushbuttons on the gas sensing module for about 5 seconds. Then release.

The indicator will be RED denoting that the module is now setup ready for:



Calibrate ZERO
OR

Calibrate SPAN

Refer to Section 8.3

Refer to Section 8.4



When the Gas Sensing Module is setup into the CALIBRATE MODE it will instruct the transmitted output signal of the sensor to be FIXED at a value of 0.00. This will prevent the possibility of false alarm signals being activated in the

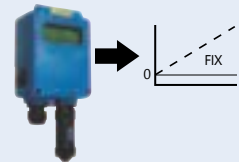

monitoring equipment during the calibration process. The display will continue to show the measured value of gas concentration during the calibration process.

This function is not operational on 4 to 20 mA, 2 wire systems.

INSTALLATION & OPERATING DATA

8 CALIBRATION *continued*



ANZEx

EAC



8.3 Calibrate ZERO



Apply purge air, at a flow rate of 0.2 to 1 l/min, for a few seconds to clear all remnants of gas.



The Gas Sensing Module will automatically return to the NORMAL measuring mode if NO pushbuttons are operated within 60 seconds.

Press CALIBRATE ZERO (5 seconds) until the indicator is flashing GREEN (3 times).



Release and the indicator will briefly show RED to denote ZERO setup.



The Gas Sensing Module will commence auto-zero. Once the auto-zero has completed, the indicator will briefly show amber to indicate trim mode has been entered.



TRIM MODE

Trim mode allows the output from the GSM to be adjusted to give an accurate 'zero' level. During this mode, the CALIBRATE ZERO button decreases the output signal and the CALIBRATE SPAN increases it. Once set, the GSM will return automatically to normal mode about 25 seconds after the last button press.

8 CALIBRATION continued



8.4 Calibrate SPAN



Apply test gas, at a flow rate of 0.2 to 1 l/min, for a few seconds until the display value stabilises.



The Gas Sensing Module will automatically return to the NORMAL measuring mode if NO pushbuttons are operated within 50 seconds.

Press CALIBRATE SPAN (5 seconds) until the indicator is flashing YELLOW (3 times).

(SPAN CALIBRATION will not occur if an insufficient concentration of span gas is present).

SCROLL the display value UP/DOWN until it concurs with the value of gas concentration marked on the test gas canister.

50 seconds after SCROLLING has ceased the gas sensing module will automatically return to the NORMAL measuring mode.

Keep the test gas applied for a few seconds to verify the response of the sensor.

Switch off the test gas supply.



9 MAINTENANCE

It is good safety practice to carry out regular preventative maintenance to confirm correct operation.

9.1 Output Signal

Check the response of the sensor at pre-determined intervals by injecting a test gas using a Trolex TX6520.32 Gas Test Kit.

Compare the value of the display with the value marked on the test gas canister.

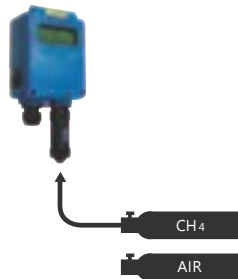

9.2 Proof Test

Calibrate the TX6373 using the instructions in Section 8.

Insert an approved test meter into the signal line.

Inject a test gas using a Trolex TX6520.32 Gas Test Kit.

Compare the value on the test meter display with the measured line value.

If the value on the test meter does not match the value on the display:

Recalibrate and then carry out the proof test again

OR

change the gas sensing module, calibrate and then carry out

the proof test.

Refer to Section 8

Refer to Section 9.2

9.3 Gas Sensing Modules

The gas sensing modules should be changed at regular intervals to ensure accuracy of response.

Electrochemical cells contain an electrolyte that is gradually consumed during use.

The average life is about two years, influenced mostly by duty cycle, ambient temperatures and humidity. The shifting response of the cell should be checked at regular intervals.

The modules are conveniently replaceable giving a pre-calibrated standardised output signal. They can be changed in seconds.

Service replacement modules can be supplied by our Product Support Department on a regular basis.

Simply insert the new module into the instrument and return the original for checking and calibration.

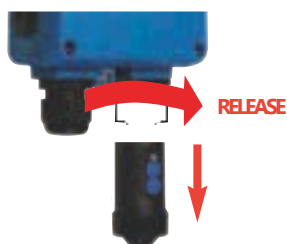
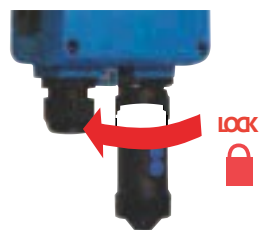

The sensor will transmit a LOW alarm signal if a replacement gas sensing module is not fitted within 15 seconds



ANZEx



9 MAINTENANCE continued

9.4 Display

In addition to displaying the gas type and actual gas readings, the display can indicate the status of the instrument.

Head Removal

If a gas sensing head is removed, the display will indicate this by showing .

The output current will fall to about 1.5 mA for 2-wire systems. On non-2-wire systems the output signal will remain fixed for 15 seconds and then down scale to about 3 mA.

If the head is replaced, then normal operation is resumed.

Underrange

If for any reason the signal from the head drops below the normal baseline level (head failure for example) the display will indicate . Once the underrange condition is cleared, then the display will return to normal.

Overrange

If the gas sensing head 'sees' a gas concentration of 1% or more above its full scale output, the display will indicate .

This mode may only be cleared by cycling the power.

9.5 Remove Gas Sensing Modules (TX6373.84)

Insert a bar into one of the radial holes in the gas inlet bush (take care not to damage the internal filter) and unscrew the gas inlet bush. Remove the filter from the gas inlet bush. Clean or replace the filter as necessary. Fit a new or cleaned filter to the gas inlet bush. Using a spanner, remove the sensor retaining nut from the remote housing. Remove the gas sensing module from the remote housing. Fit a new gas sensing module to the remote housing, refit the sensor retaining nut and tighten. Refit the gas inlet bush and tighten using a bar inserted into one of the radial holes, taking care not to damage the filter.



9.6 Annual Safety Check

The main transmitter itself will not normally require maintenance or calibration but it is advisable to return it to the Trolex Product Support Department for an annual safety check.

9.7 Damaged Sensors

A Sensor that has been dropped or damaged in any way should be taken out of service immediately for inspection, repair and re-calibration.

9.8 Record Keeping

Institute a regular calibration and maintenance procedure and keep a record.

Incorrect use of the Sensor or inadequate maintenance may not necessarily be self evident in the Sensor and consequently it must be regularly checked and maintained.



ANZEx



INSTALLATION & OPERATING DATA

9 MAINTENANCE *continued*

9.9 Maintenance and Calibration Log

ORDER REF TX6373	DATE SUPPLIED
SERIAL No.	USER
GAS TYPE	LOCATION



ANZEx

EAC



DATE	SCHEDULED	FAILURE	RE-CALIBRATE	CHANGE GAS SENSING MODULE	RETURN TO MANUFACTURER	COMMENTS

10 APPROVALS AND CERTIFICATION

10.1 Europe (ATEX)



TX6373.01.xx Toxic Gas Sensor / Transmitter (Group I)

Ex Certificate number:

SIRA 02ATEX2052X

Ex Certification code:

I M1 Ex ia I Ma (Ta = -20°C to +60°C)

TX6373.02.12 Toxic Gas Sensor / Transmitter (Group II)

Ex Certificate number:

SIRA 02ATEX2052X

Ex Certification code:

II 1G Ex ia IIC T4 Ga (Ta = -20°C to +60°C)

Special Conditions for Safe Use

When the TX6373 is specifically required for group II, category 1 equipment, the TX6373 should not be installed in a location where the external conditions are conducive to the build-up of electrostatic charge as the polycarbonate window may store an ignition-capable level of electrostatic charge. Additionally, the equipment should only be cleaned with a damp cloth.

General Conditions for Safe Use

Prior to installation, it is essential that user refers to the above certificate to ensure that the termination and cable parameters are fully complied with and are compatible with the application. Copies of certificates are available from Trolex.



ATEX Directive (94/9/EC)

10.2 Australia/New Zealand (ANZEx)



TX6373-series Toxic Gas Sensor / Transmitter

Ex Certificate Number:

ANZEx 12.3016X

Ex Certification Code:

Ex ia I (Ta = -20°C to +60°C)

Ex ia IIC T4 (Ta = -20°C to +60°C)

Special Conditions for Safe Use:

Prior to installation, it is essential that the user refers to the above certificate to ensure that the termination and cable parameters are fully complied with and are compatible with the application. Copies of certificates are available from Trolex.

When the TX6373 is specifically required for group II, Zone 0, the TX6373 should not be installed in a location where the external conditions are conducive to the build-up of electrostatic charge as the polycarbonate window may store an ignition-capable level of electrostatic charge. Additionally, the equipment should only be cleaned with a damp cloth.



ANZEx



10 APPROVALS AND CERTIFICATION *continued*

10.3 Russia (Customs Union)

	Ex certificate number:	TC RU C-GB.ГБ05.B.00356
	Ex certification codes:	PO Ex ia I Ma
		0 Ex ia IIC T4 Ga

Conditions of Use:

Prior to installation, it is essential that user refers to the above certificate for any specific conditions of use. The user must ensure that the termination and cable parameters are fully complied with and are compatible with the application. Copies of certificates are available from Trolex.

10.4 South Africa (MASC)

	Ex certificate number:	MASC MS/11-358X
	Ex certification codes:	Ex ia I (-20°C ≤ Ta ≤ +60°C)
		Ex ia IIC T4 (-20°C ≤ Ta ≤ +60°C)

Specific Conditions of Use:

Under certain extreme circumstances, the polycarbonate window may store an ignition-capable level of electrostatic charge. Therefore, when it is used for applications that specifically require group II, category 1 equipment, the TX6373 shall not be installed in a location where the external conditions are conducive to the build-up of electrostatic charge. Additionally, the equipment shall only be cleaned with a damp cloth.

General Conditions of Use:

Prior to installation, it is essential that user refers to the above certificate to ensure that the termination and cable parameters are fully complied with and are compatible with the application. Copies of certificates are available from Trolex.

10.5 India (CIMFR)

	Test report number:	CIMFR/TC/P/H630
---	---------------------	-----------------



ANZEx



11 FUNCTIONAL SAFETY

11.1 Overview of Safety Integrity Level

The following instructions are applicable when the TX6373 Toxic Gas Sensor/Transmitter is used as an element in a safety instrumented function that is specified to achieve a Safety Integrity Level (SIL), eg, SIL 1, SIL 2, etc.

The reliability of the TX6373 Toxic Gas Sensor/Transmitter has been independently assessed in accordance with IEC 61508 for use in SIL applications. The compliance with IEC 61508 includes hardware reliability (probabilistic type failures) and measures to address systematic type failures.

The information that follows forms the 'Safety Manual' required by IEC 61508-2 and is intended to allow correct product selection, system integration, installation, operation and maintenance to enable the SIL specified for the safety instrumented function to be achieved and maintained, as far as the TX6373 Toxic Gas Sensor/Transmitter is concerned.

The actual SIL will depend on many system considerations that are outside the scope of the TX6373 Toxic Gas Sensor/Transmitter and will rely on personnel who are competent in the functional safety aspects of the various lifecycle activities mentioned above.

11.2 SIL Suitability

The versions and configurations of the TX6373 Toxic Gas Sensor/Transmitter identified in Table 1 in Section 11.3 below are suitable for use in gas detection safety functions that have a specified Safety Integrity Level (SIL) in accordance with IEC 61508 or IEC 61511 up to and including:

SIL 2 - when used in a 'Low Demand' safety function ^[1]

SIL 1 - when used in a 'High Demand' safety function ^[1]

The functional safety data in Tables 1 and 2 in Section 11.3 must be taken into account by integrators and end-users, including compliance with the restrictions in use (Section 11.4) and all other provisions and conditions in this manual.

System integrators and end users responsible for other lifecycle phases (system specification, integration, installation, commissioning, operation, maintenance, etc) need to perform assessments on the complete scope of their activities to ensure a target SIL for the safety function is and continues to be met.

^[1] Low Demand and High Demand modes of operation are defined in IEC 61508-4, 3.5.16



11 FUNCTIONAL SAFETY *continued*

11.3 Summary of the Verified Functional Safety Data

The product, configuration and Safety Manual that have been assessed are shown in Table 1.

Product Information	Details
Product identification	TX6373.01.12 / TX6373.84.01.12 / TX6373.02.12 / TX6373.84.02.12 - Toxic Gas Detector
Product specification	See Section 4 of this manual
Product configuration	4 to 20 mA output Sensor types: CO, H ₂ S, SO ₂ , H ₂ , NH ₃ , NO ₂ , Cl ₂ , NO, O ₂
System configuration	2/3-wire loop, or 4-wire powered connection; power supply and load as specification (noting Group I certified equipment requirements)
Element safety function	To produce a 4 to 20 mA output that correlates with a specific toxic gas concentration range
Safety Manual	See Section 11 of this manual

Table 1 Basic Element Information

The hardware failure data for the TX6373 element safety function is based on an extensive analysis of field failure data with a 90% single sided confidence limit is shown in Table 2.

Parameter	Value
Dangerous failure rate (λ_D)	3.1E-07
Safe failure rate (λ_s)	N/R ^[1]
Safe failure fraction (SFF)	N/R ^[1]
Element type	Type B
Hardware fault tolerance (internal architecture)	0
Diagnostic coverage (DC)	60%
Diagnostic test interval	N/A ^[2]
Probability of Failure on Demand (PFD _{AVG}) ^[1 year proof test; 24hr MTTR]	1.4E-03 ^[3]
Probability of Failure on Demand (PFD _{AVG}) ^[3mth proof test; 24hr MTTR]	3.5E-04 ^[3]
Probability of dangerous Failure per Hour (PFH)	3.1E-07

Table 2 Hardware Failure Data

^[1] Not required by Route 2_H

^[2] This parameter is determined by the controller being used

^[3] To be conservative, no credit has been taken for effectiveness of the diagnostics



11 FUNCTIONAL SAFETY *continued*

11.4 Conditions or Restrictions for use in SIL Applications

The sections of this Installation and Operating Data Manual shall be strictly complied with to ensure validity of the failure data and systematic safety integrity. The following additional restrictions and conditions apply when the unit is used in SIL applications:

1. The host controller must monitor the TX6373 Toxic Gas Sensor/Transmitter output at an appropriate frequency for the application (safety time) and initiate a safe action (eg. process shutdown, evacuation, etc) or be repaired within the MTTR assumed in the PFD calculations shown in Table 2 in Section 11.3 above, if an out-of-range (low) output signal is indicated.
2. If the MTTR or the proof test interval (T_1) is different from those assumed in this document, then the PFD_{AVG} should be re-calculated and the SIL capability re-verified accordingly (refer to the Safety Manual in Section 11.5 below).
3. The display is for indication only and is not part of the safety function.
4. The environmental limits are restricted to:
 - +20 to +40°C
 - relative humidity <90%.
5. IEC 61508-2, 7.4.4.3.1c limits use to SIL 1 in high or continuous mode of operation when used in a non-redundant configuration.
6. The unit must be calibrated at commissioning and at 3 month intervals during operation and the sensor head replaced as indicated by the calibration check.

11.5 Proof Testing

Periodic proof tests of the element safety function must be performed to identify any dormant failures, particularly when used in 'low demand' safety functions - refer to Section 9.2 of this manual, for the proof test procedure. (Note that calibration alone does not operate the 4 to 20 mA signal). Faults identified by this test must be repaired within the MTTR and the unit returned to full working order.

A suitable proof test interval (T_1) should be used in order to achieve the required average probability of failure on demand (PFD_{AVG}). A nominal interval of 8,760 hrs (1 year) and Mean Time to Repair (MTTR) of 24 hours has been used in the derivation of PFD_{AVG} for illustration purposes. If different values are used, the PFD_{AVG} for a non-redundant arrangement (ie. where the safety function relies on a single element) can be re-calculated as follows:

$$PFD_{AVG} = (\lambda_{DU} + \lambda_{DD}) t_{CE}$$

Where t_{CE} (the channel equivalent down time) = $(\lambda_{DU} / \lambda_D) (T_1/2 + MTTR) + (\lambda_{DD} / \lambda_D) MTTR$

For redundant arrangements refer to IEC 61508-6 for the equations.



Those responsible for specifying proof testing of safety functions should refer to IEC 61508-6:2010 clause B.3.2.5 for considerations of the effect of non-perfect proof tests.



ANZEx



11 FUNCTIONAL SAFETY *continued*

11.6 System Configuration Drawing

The illustration below shows how the TX6373 is to be used with other system elements.



If a controller other than the TX9042 is used then the out of range (fault indication) signal from the TX6373 must be detected and acted upon to assert a system fault.



ANZEx

