



# AUDIO/VISUAL ALARM

**combination audible and visual alarm signalling device for use with sensors and monitoring systems**

## INSTALLATION & OPERATING DATA



**A T E X**  
GROUP I  
INTRINSICALLY  
SAFE

**FOR USE WITH  
SENSORS AND  
MONITORING  
SYSTEMS  
IN  
HAZARDOUS  
AREAS**



**direct sensor mounting**

The alarm can be fitted directly to any Trolex sensor/transmitter. Connections are made to the sensor terminals inside the sensor housing.



**junction box mounting**

The alarm can be supplied fitted directly to a junction box. Many sizes available.

### contents...

	page
1 PRINCIPAL OPERATING FEATURES	2
2 DIMENSIONS	2
3 TECHNICAL DETAILS	2
4 ELECTRICAL DETAILS	3
5 SETUP	4
6 APPLICATION	4
7 CERTIFICATION AND APPROVAL	4

**INSTALLATION & OPERATING DATA**



**1 PRINCIPAL OPERATING FEATURES**

- Compact and strong polycarbonate housing.
- Self contained construction saves cost of installation and cabling.
- High intensity LED all-round visual flashing alarm with 85dB audible sounder.
- Confidence blip at 15 second intervals.
- Choice of input signal; Contact state or analogue.
- 4...20mA or 0.4...2V analogue compatibility with user adjustable alarm trigger setpoint.
- Certified intrinsically safe to CENELEC standard for use in Group I hazardous areas.
- Versions with visual alarm only.

**2 DIMENSIONS**

ALL DIMENSIONS IN MM

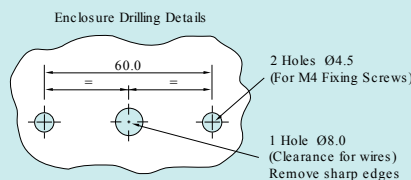
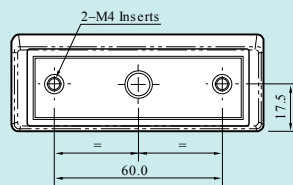
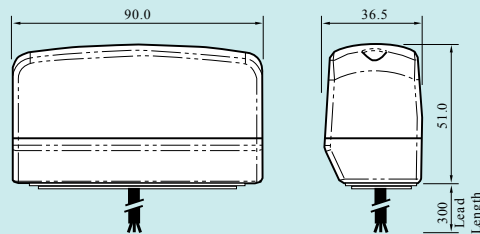

- Max. insertion from inner wall of enclosure 10mm + wall thickness (T).
- Min. insertion from inner wall of enclosure 7mm + wall thickness (T).

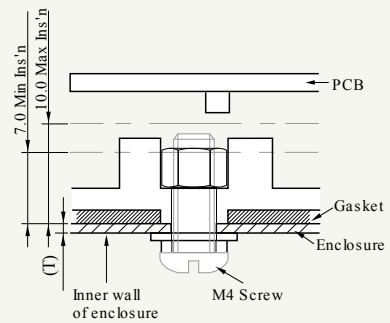

**Ex**  
**ATEX**  
**GROUP I**  
**INTRINSICALLY**  
**SAFE**

**3 TECHNICAL DETAILS**

Light Source:	High intensity LEDs.
Input Signal:	<ul style="list-style-type: none"> <li>• Contact state. CLOSE or OPEN for alarm.</li> <li>• Analogue signal with potentiometer adjustable setpoint for UNDER or OVER alarm.</li> </ul>
Audible Alarm:	High intensity audible sounder 85dB @ 1 metre (12V dc).
Alarm Indication:	<ul style="list-style-type: none"> <li>• 1/sec flashing visual with optional audible alarm.</li> <li>• Confidence blip at 15 second intervals.</li> </ul>
Alarm Signal Out of Limits:	Alternating LED flash with double sounder 'beep' (when fitted).
Hysteresis:	5% of setpoint.
Housing Material:	Polycarbonate.
Protection Class:	IP65 (Sounder: IP54).
Nett Weight:	100gms.

**INSTALLATION & OPERATING DATA**

**4 ELECTRICAL DETAILS**



Supply Voltage:	7.5...16.5V dc		
Power Consumption:	15mA (mean). 75mA peak during LED flash state.		
Analogue Input Signal:	4...20mA / 0.4...2V options.		
State Input Signal:	(low):	0V min.	1.1V max.
	(high):	1.3V min	+Supply V max.

**Connections**

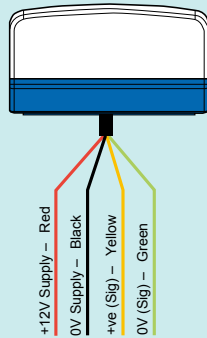

Ensure that the unit is set up correctly.



The TX6831 Audio/Visual Alarm must only be interconnected with approved power supplies, signal sources and monitoring equipment when used in hazardous areas.



**ATEX**  
GROUP I  
INTRINSICALLY  
SAFE

**4.1 Connecting into a 4...20mA signal loop.**

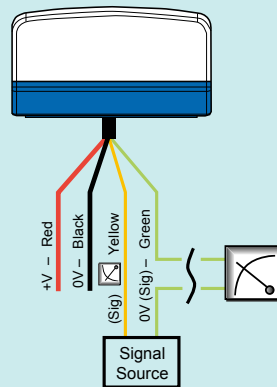

REMOTE MONITORING DEVICE

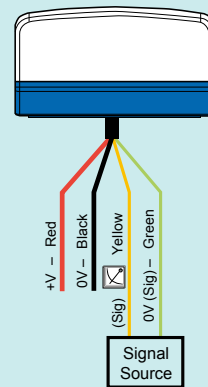

ONLY THE AUDIO/VISUAL ALARM  
IN THE LOOP

**4.2 Connecting to a 0.4...2V signal source.**

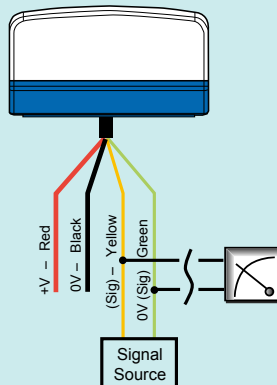

**4.3 Volt-free input contact.**

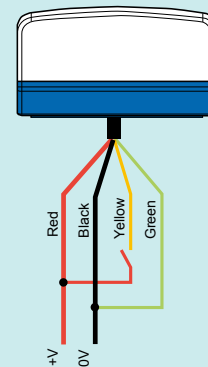

**4.4 5V State input.**

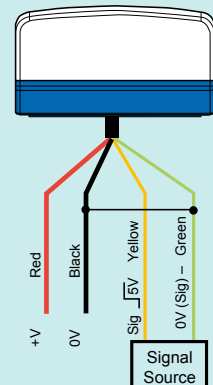

**INSTALLATION & OPERATING DATA**



**5 SETUP**

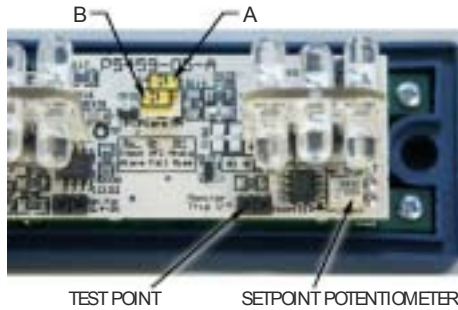

**ADJUSTING THE SETPOINT**

- The setpoint can be setup empirically by adjusting the SETPOINT potentiometer.
- For more accurate setup, connect an approved test instrument (0...2V) to the TEST POINT and adjust the SETPOINT to the desired level.

**TYPE OF INPUT SIGNAL**

	4...20mA Analogue Input	0.4...2V Analogue Input	5V State Input	Contact State Input
<b>A</b>	OFF	OFF	ON	ON

0.4V	4mA	0.4V
2V	20mA	2V

**ALARM SETPOINT MODE**

	Analogue Input	Analogue Input	Voltage Free Contacts
<b>B</b>	Alarm on rising signal = OFF	Alarm on 'high' level = OFF	Alarm on contacts closing = OFF
	Alarm on falling signal = ON	Alarm on 'low' level = ON	Alarm on contacts opening = ON

**6 APPLICATION**

**6.1 A TX6373 Gas Sensor fitted with a TX6831 Audio/Visual Alarm (4...20mA)**

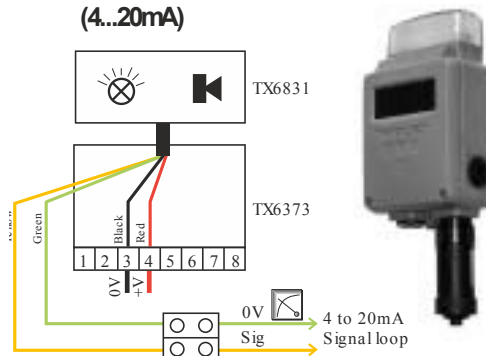

- A 2-way terminal block will be required within the termination chamber in order to connect to the 4...20mA loop.

**6.2 A TX5921 Vortex Air Flow Sensor fitted with a TX6831 Audio/Visual Alarm (4...20mA)**

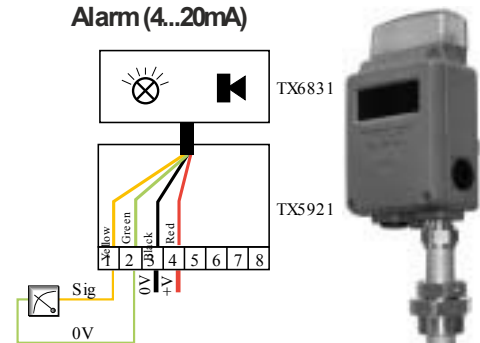

- The TX6831 Audio/Visual alarm uses the same power supply connections as the TX5921 Vortex air flow sensor.

**7 CERTIFICATION & APPROVAL**



Certified IS to Euronorm Standards  
• EEx ia I IMI



Designed to comply with  
• ATEX directive (94/9/EEC)  
• EMC directive (89/336/EEC)

**SPECIAL CONDITIONS FOR SAFE USE**  
The internal temperature of this equipment may rise above 150°C under normal or fault conditions, therefore, care shall be taken when the enclosure is opened to ensure that no dust enters the equipment.

**INSTALLATION & OPERATING DATA**

**PROTECTING THE ENVIRONMENT**



Many of our products are often used to monitor the quality of environmental conditions consequently Trolex is also particularly aware of the need to protect human health and the environment in which we live.

The Company has instituted a radical environment protection policy to ensure that all aspects of our manufacturing programme have the minimum possible detrimental impact on the environment. This covers all stages beginning with sustainable product design supported by careful selection of the materials used in their production, through to managed recovery and disposal at the end of the useful life of a product.

This policy also incorporates the principles of the Waste Electrical and Electronics Equipment (WEEE) directive, and the associated Restriction of Hazardous Substances (RoHS) directive, to be implemented in EU countries.

Progress is already well advanced on the introduction of a completely new range of products that maximise the central principle of sustainable design with the intention of reducing the end-of-life cost to the end user.

All Trolex products are manufactured to exacting standards in accordance with our stringent quality control ethos. Having chosen to use one of our products will, in itself, guarantee extended durability and a long operating life, endorsed by our commitment to recycling and recovery.

■ All packaging materials are carefully selected to be bio-degradable or re-cycleable where possible.

■ All plastic materials are identified for recycling purposes and re-cycled materials are used where it is possible to do so.

- Printing paper and material are sourced from suppliers that have a declared environmental management system.
- Product design centred around high quality and long term durability. Modular architecture both in construction and software design suitable for future upgrades and adaptability to alternative duty.
- Ease of product disassembly, minimisation of fixing devices, and clear separation of functional parts to benefit re-use and re-cycling.
- Control and monitoring of suppliers of components and sub-assemblies. Deal only with suppliers that have a defined commitment to environmental monitoring principles.
- Control the use of restricted substances within the design process. Deal only with suppliers that have a defined commitment to the control of restricted substances.
- Provide an efficient high speed service within Trolex for repair, refurbishing and conversion of products for alternative duty.
- Provision of an end-of-life product Take-back service for recovery, re-use, and recycling of electrical and electronic components. Retain the packaging of a new product and re-use it to return the device to us at the end of its working life. Trolex will guarantee to recover all materials and components, where practicable and arrange for them to be re-cycled in an appropriate and in a safe manner.

**TROLEX LIMITED**  
NEWBY ROAD, HAZEL GROVE, STOCKPORT,  
CHESHIRE SK7 5DY, UK  
**+44 (0)161 483 1435**  
**sales@trolex.com**  
**www.trolex.com**