

TX9030
series

PROGRAMMABLE TRIP AMPLIFIER



Further copies of this document are available from
troxel.com

TROLEX LIMITED
Newby Road, Hazel Grove, Stockport, Cheshire SK7 5DY, UK.
Tel: +44 (0)161-483 1435 E-mail: sales@trolex.com
Internet: www.troxel.com

INDEX

	<i>Page</i>
1. PRINCIPAL OPERATING FEATURES	3
2. APPLICATION	3
3. PREPARATION	3
4. DIMENSIONS	4
5. TECHNICAL DETAILS	4
6. CONNECTIONS	5
7. CONTROLS AND INDICATORS	8
8. INFORMATION DISPLAY	8
9. THE MENU OF FUNCTIONS	10
10. ENTERING THE MAIN SETUP	11
11. CALIBRATE THE REPEATER OUTPUT SIGNAL	12
12. POWER ON DELAY PERIOD	13
13. SCALE AND DISPLAY SETTINGS	14
13.1 Units	14
13.2 Decimal point	15
13.3 Update	15
13.4 Lower	16
13.5 Upper	16
14. SETPOINT CHARACTERISTICS	17
14.1 Level	17
14.2 Hysteresis	17
14.3 Alarm	18
14.4 Delay (ON)	18
14.5 Delay (OFF)	18
14.6 Operation	19

	<i>Page</i>
15. CONTRAST CONTROL	20
16. KEYCODE	20
17. APPROVALS	21

1. PRINCIPAL OPERATING FEATURES

The TROLEX TX9030 series of Programmable Trip Amplifiers offers complete versatility of sensor monitoring through an easy to use, fully programmable menu system, with a large range of operating options.

Developed specifically for monitoring sensors in industry, we have exploited our years of experience in the field of industrial controls and sensor applications to produce a system that offers unparalleled simplicity of operation.

The Trip Amplifier will accept input signals from a variety of analogue sensors. The input signal is conditioned and processed, by a microprocessor, to control two independent output relays with indicating LEDs and a dot matrix data display. Some versions are provided with a repeater output signal for communicating with remote data systems.

All functions of the Trip Amplifiers can be programmed, by the user, through the 4-way keypad. A simple, easy to use, menu system guides the user through the programming sequence and all settings are retained under power failure.

External control functions are also available for POWER ON DELAY which can be used to inhibit the output relays during the warm-up or start up period of a machine or process, and an external reset input is provided to reset any latched alarm functions.

Further technical application data is available on request and our Applications Department will be pleased to provide any technical advice and support that you may require.

2. APPLICATION

- Environmental monitoring.
- Gas detection systems.
- Conveyor monitoring.
- Pump and compressor monitoring.
- Machine condition monitoring.
- Fan vibration monitoring.
- Plant protection.

There are three mountings formats:-

- DIN Rail Mounting.
- 19" Rack Mounting.
- Front of Panel Mounting.

The modules can be incorporated into existing equipment or fitted into the standard range of TROLEX housings.

3. PREPARATION

3.1 Check that the supply voltage is correct (i.e. 20...28V).

Check that the INPUT signal format is compatible with the sensor or system being used.

Check that the OUTPUT contact/signal format is compatible with the system being used.

3.2 The conventional fail safe mode for relay output contacts is NORMALLY OPEN so that if a power supply failure occurs or an output fails, the contact of the relay will OPEN.

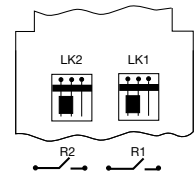

The Trip Amplifier is supplied with output contacts set NORMALLY OPEN when the output relay is DE-ENERGISED.

The contacts can be changed to NORMALLY CLOSED if required:-

- Remove the back cover.
- Two miniature plastic connectors on the bottom PCB determine the contact mode. Change either or both as required.
- Replace the back cover.

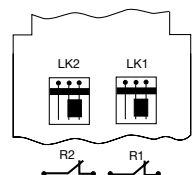

This does not affect the ELECTRICAL operation of the relay. This also can be programmed for a RISING or FALLING alarm function (Sections 6.2 and 14.3).

4. DIMENSIONS

4.1 DIN RAIL MOUNTING

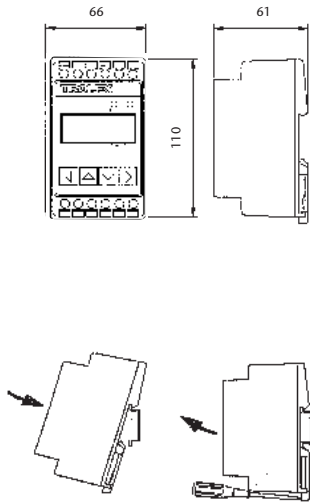

4.2 19" RACK MOUNTING

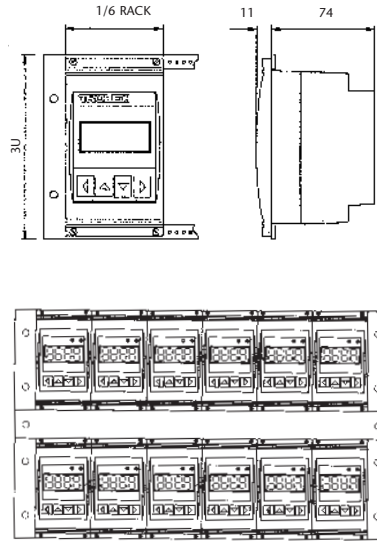

4.3 FRONT OF PANEL MOUNTING

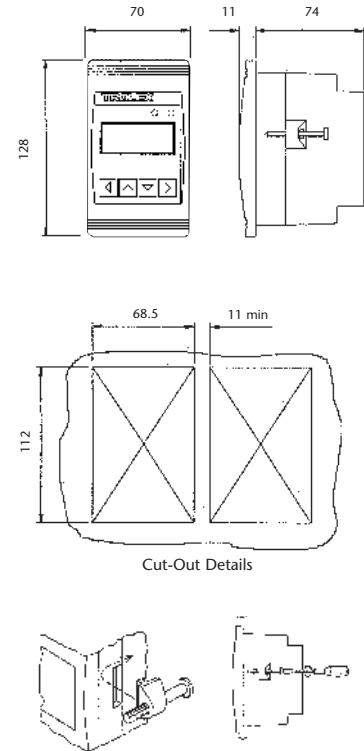

NB: The front of the panel seal is environment proof to IP65, enabling the module to be used in outside operating conditions.

5. TECHNICAL DETAILS

Display Accuracy:	±0.5% (analogue channels).
Set Point Accuracy:	±0.5%.
Ambient Temperature Limits:	-10...50°C.
Electrical Connections:	4mm barrier/clamp terminals.
Housing Material:	ABS.
Nett Weight:	300gms.
Information Display:	LCD. 16 characters x 2 lines. 5mm high.
Mounting:	DIN Rail (EN 50022), 19" Rack or Front of Panel.
Operation:	Microprocessor controlled, menu operation with non-volatile data retention.
Set Point Adjustment:	0...99%.
Hysteresis Adjustment:	0...99%.
Power ON Delay Adjustment:	0...255 seconds.
Output Delay Adjustment:	0...25 seconds.
Engineering Units Menu:	mV, V, mA, A, °C, °F, g, kg, mbar, bar, Pa, kPa, PSI, %, ppm, %RH, mm, m, m/s, mm/s, m3/s, ft, ins, ft/sec, rpm, pps, Hz, kHz, g, m3, %LEL, %v/v, (ASCII code user entry).
Input Signal Averaging: Period Adjustment:	0...250 seconds.
Input Signal Failure Alarm:	Open or Short Circuit signal line will de-energise both output relays and display HIGH or LOW SIGNAL ERROR.
Supply Voltage:	20V...28V dc.
Supply Current:	40mA at 24V (With both relays energised).
Output Relays:	Two relays with independent setpoint adjustment.
Relay Contact Rating:	5A 230V ac. Changeover contacts.
Contact Format:	NORMALLY OPEN or NORMALLY CLOSED (user selectable).
Repeater Output Signal:	4...20mA Analogue (Max. load resistance 600R).

6. CONNECTIONS

The TX9030 Series Trip Amplifier offers the choice of the following analogue input signals.

- TX9031 Current signals: 4...20mA.
- TX9032 Voltage signals: 0.4...2V.

Versions are also available with a 4...20mA repeater output signal in place of the second relay, R2.

6.1 Connections

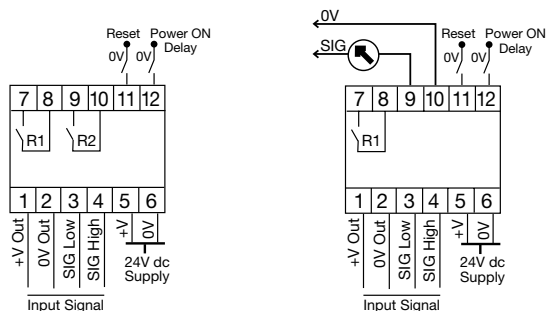

6.2 Relays are shown de-energised – i.e. POWER OFF or setpoint EXCEEDED.

3

6.3 Terminal 12 is used to control the POWER ON DELAY facility.
 0V = INHIBIT.
 Open Input = Start the POWER ON DELAY time period (leave open if not used).

12

6.4 Terminal 11 is used to RESET any LATCHED relays and to reset the count display from an external contact impulse.
 0V = RESET.

14.6

INPUT CHANNEL CONFIGURATION

	RANGE	CONNECTIONS
<p>6.5 TX9031 Current</p> <p>Fully floating differential input.</p>	<p>0...20mA. 4...20mA.</p> <p>Impedance: 10R.</p>	<div style="display: flex; justify-content: space-around;"> <div style="text-align: center;"> <p>2 wire (loop powered)</p> </div> <div style="text-align: center;"> <p>3 wire (separate powered)</p> </div> </div>
<p>6.6 TX9032 Voltage</p> <p>Fully floating differential.</p>	<p>0...2V. 0.4...2V. 0...10V.</p> <p>Impedance: 100K.</p>	<div style="display: flex; justify-content: space-around;"> <div style="text-align: center;"> <p>3 wire (short distance)</p> </div> <div style="text-align: center;"> <p>4 wire (long distance)</p> </div> </div>

Refer to section

6.7 Cable Distance Calculation for Loop Powered, 4...20mA Sensors.

Maximum cable distance. = $\frac{V_s - V_{ms}}{0.02 \times R \text{ cable}}$ km.

V_s = Supply voltage.

V_{ms} = Minimum acceptable sensor voltage (eg 20V).

R cable = Total resistance of connecting cable in ohms/km.

6.8 Adding a Digital Display into a 4...20mA Signal Loop.

It is sometimes necessary to provide readout at a remote point somewhere along a 4...20mA signal loop.

A Trolex TX9061 loop powered display can be added into the loop at any point to display the signal value.

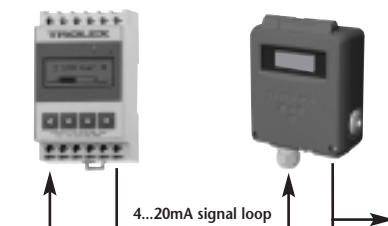

6.9 Cable Distance for Voltage Inputs (0.4...2V).

The input impedance of the Trip Amplifier is very high, so cable distance is usually not a problem. Voltage drop in the power supply line is the critical factor, particularly on a three wire system where the 0V of the power supply line is 'commoned' with the signal line.

Use a 4 wire system on distances above 100m to minimise this effect.

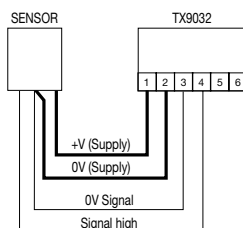

6.10 Dual Input Signals (Differential).

The differential input stage of the 0.4...2V version of the Trip Amplifier also enables it to monitor two input signals simultaneously and respond to the difference between the two.

This technique is frequently used to monitor differential temperature, differential pressure and differential speed. It is important, however, that the two sensors or input signals are calibrated to the same operating parameters.

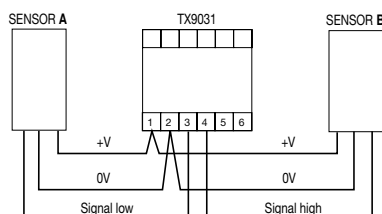

6.11 Repeater Output Signal.

Where a repeater output signal is fitted it will displace output relay R2.

The magnitude of the signal is proportional to the display value (Lower to Upper).

13.4 &
13.5

<p>4...20mA</p>	<p>Standard current regulated signal loop.</p> <p>Maximum loop impedance : 600R @ 24V supply.</p> <p>Supply voltage: 20V...28V dc.</p>	
------------------------	--	--

Refer to
section

7. CONTROLS AND INDICATORS

7.1

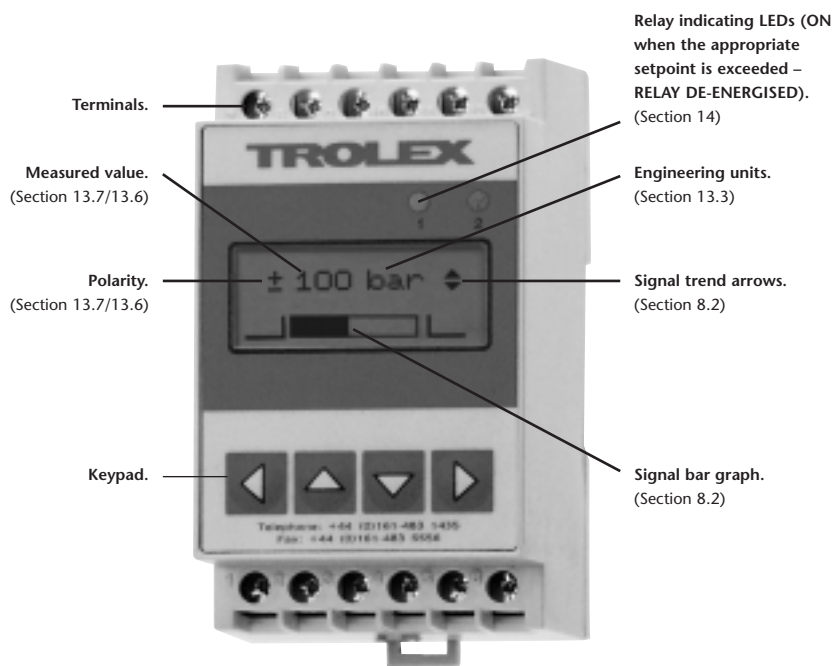

7.2 Keypad Functions

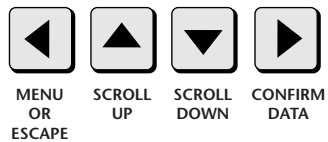

— Hold the SCROLL Keys down for two seconds for rapid self keying.



DATA MEMORY

The data memory is permanent and all settings are retained with power failure.

8. INFORMATION DISPLAY

8.1 Switching ON.

When first switched on, the processor will initialise previously programmed settings and any default values.

See the MENU OF FUNCTIONS for default values

9

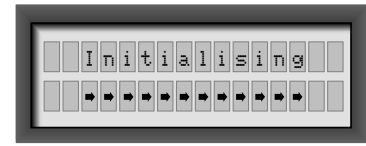

8.2 Signal Display.

The display will now show the main SIGNAL DISPLAY.

The 'trend' of the input signal to increase or decrease will be indicated by the tendency arrows:

— : Steady unchanging input signal.

▲ : Rising tendency input signal.

▼ : Falling tendency input signal.

Slowly changing sensor signals under suspicion may be assessed.

7



- If any POWER ON DELAY has been previously programmed, the display will initially show the length of delay in seconds.

The displayed time will count down until the POD period is complete then the display will revert to the SIGNAL DISPLAY.

12



8.3 Measuring the Supply Voltage.

The incoming supply voltage to the Trip Amplifier can be checked.

Key ► to DISPLAY the voltage.

(The display will also show the software version: Vx.x.).

A warning will be given if the supply falls below 20V.

14.1



8.4 Relay Setpoint Review.

The programmed relay setpoint levels can be reviewed on the display.

Key ▲ to DISPLAY the setpoint levels.

R. Denotes a RISING alarm function.

F. Denotes a FALLING alarm function.

14.3



R1 R2
● ●



8.5 Peak/Low Review.

PEAK: The stored value of the MAXIMUM Signal value since last reset.

LOW: The stored value of the MINIMUM Signal value since last reset.

Key ▼ to DISPLAY PEAK and LOW.

Key ◀ then ▶ to RESET PEAK/LOW values.

Any stored values of PEAK and LOW will automatically reset to zero when the power supply is first switched on.

Refer to section



8.6 Signal Error Information.

ANALOGUE versions will also display information about any input signal ERROR condition that has occurred. A signal that transgresses beyond its normal operating boundaries (i.e. above 2V or below 0.4V on a 0.4...2V input) will initiate warnings at preset levels of discrepancy and trigger exclusive ERROR signals.

5%

Signal exceptionally HIGH
($>2.2V$).



OVER RANGE

Signal OVER the calibrated range
(i.e. $> 2.1V$).



NORMAL

Signal Minimum/normal/maximum
(i.e. 0.4...2V).



UNDER RANGE

Signal UNDER the calibrated range
($<0.3V$).

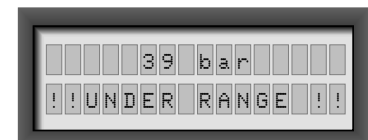

-5%

Signal exceptionally LOW
($<0.2V$).



- Error signals will de-energise Relay 1 and Relay 2.

Refer to
section

9. THE MENU OF FUNCTIONS

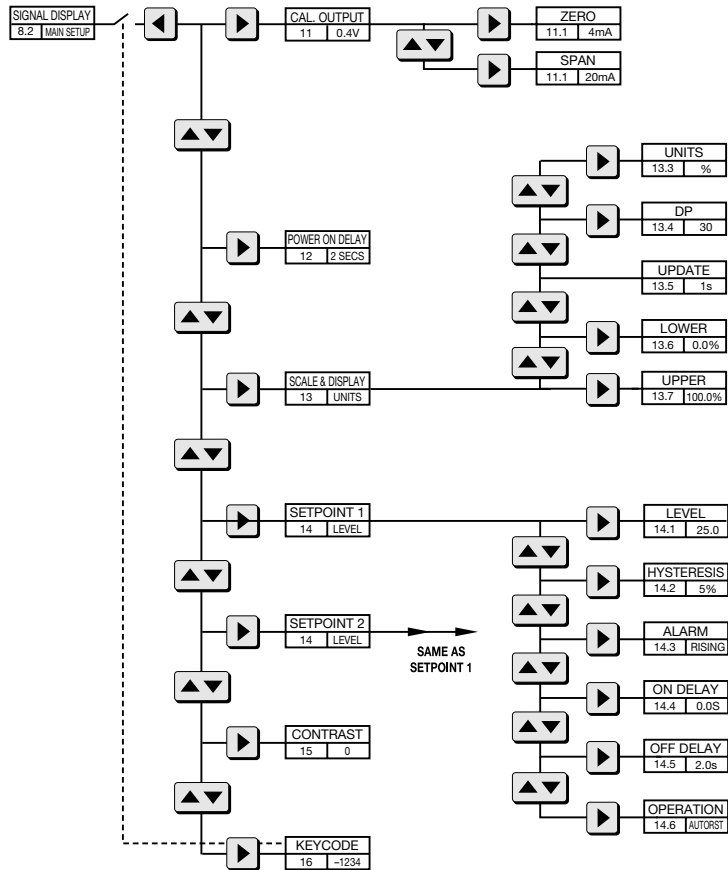
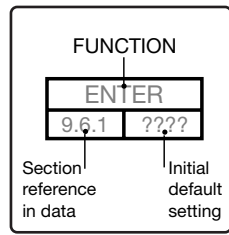

10. ENTERING THE MAIN SETUP

All the operating functions can be programmed through the keypad by entering into the MAIN SETUP menu.

10.1 Enter.

Key  to ENTER the MAIN SETUP menu.

The bottom line of the display will show the first of the options available in the MAIN SETUP menu.

(Previously programmed settings will be displayed in brackets where appropriate).

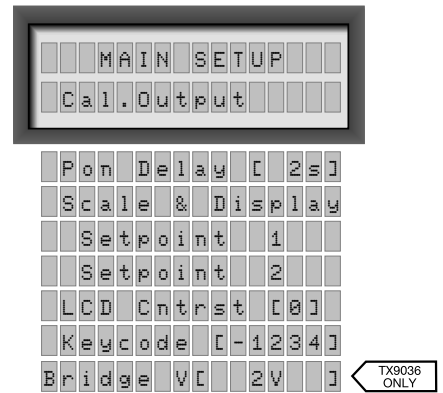

- If selected, the KEYCODE security lockout will deny entry into the MAIN SETUP until the correct entry code is confirmed.

Key  to TRAVERSE the cursor along the digits.

Key  to SCROLL the number.

Key  to CONFIRM.

16



Key  to  SCROLL up and down the menu.

Key  to CONFIRM.

(Previously programmed settings will be displayed alongside each item in a menu).

Function changes can now be programmed as described in the following sections.

- DATA SAVED will flash briefly on the display whenever a new value is entered during function programming.
- NOT SAVED will flash briefly on the display if a value is not entered during function programming.
- The display will automatically return to the MENU being used after a value or selection has been entered.



10.2 Escape.

Key  to ESCAPE from any position in the MENU sequence.

Each operation of the key will revert the display one step back until the SIGNAL DISPLAY is reached.

The display will progressively step back at 10 second intervals if no keys are operated.

Refer to section

11. CALIBRATE THE REPEATER OUTPUT SIGNAL

Some versions will have an output signal in place of Relay R2. The output signal level is directly proportional to the display value.

The signal will be calibrated during manufacture to concur with the LOWER and UPPER programmed values:

	LOWER	UPPER
4...20mA	4	20

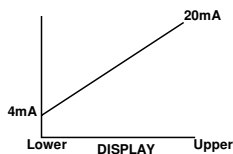

13.4 &
13.5

• **To re-adjust the repeater output signal.**

The repeater signal should not normally require re-adjustment. Recalibration can be carried out if required by connecting an accurate test instrument to the output circuit, set to the appropriate measuring range (current).

Example for 4...20mA version.

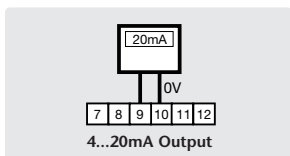

Key or to select.

Key to CONFIRM.

Key or to ADJUST the reading.

The display value shows a representation of the pulse width modulation generated by the internal processor to produce the analogue output signal and can be used as a guide depicting the increase/decrease of the signal during adjustment.

eg. $\frac{210}{49} \approx \frac{4\text{mA}}{20\text{mA}}$



Key to CONFIRM.



Refer to
section

12. POWER ON DELAY PERIOD

The setpoint output relays R1 and R2 can be inhibited for an adjustable time period after the power is switched on. This feature is useful for an initial start-up override when a machine is running up to speed or a process is stabilising.

Key  or  to SCROLL the value.

Key  to CONFIRM.

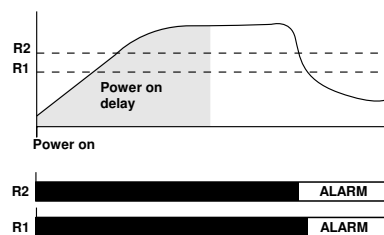

Range: 0...255s

- In a situation where the Trip Amplifier is powered from an independent power source, the commencement of the *Power On delay period* can be controlled by a remote contact.

A 0V signal on terminal **12** prevents the delay timer from starting. The *Power On delay period* can only commence when instructed from a control contact associated with the machine or process being initially started up. (The *Power On delay* will reset when the power supply is removed).

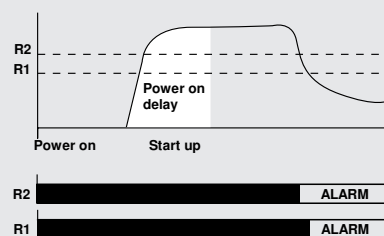
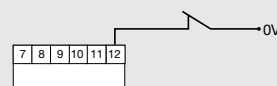

6.3

Refer to section

13. SCALE AND DISPLAY SETTINGS

The various characteristics of the signal scale and display can be determined.

- The contents of the menu will vary, depending upon the input version. See the menu of functions for individual menu listings.

Key  or  to SCROLL the menu.

Key  to CONFIRM.

13.1 Units.

A menu of standard engineering units is available for adding to the signal value display.

e.g. bar, mA, m/s, °C, °F.

(On temperature input versions, TX9033, TX9034, TX9035 the choice will be limited to °C, °F or °K).

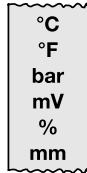

Key  or  to SCROLL the units.

Key  to CONFIRM.

- Specific Units.**

Non standard or special units can be entered at the next position in the menu.

There are 192 different characters available and up to 4 characters can be entered by a simple ASCII programme routine. Please ask for programming details if you have a specific requirement.

9 & 17



5

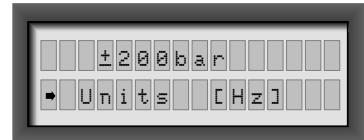

Range: (Section 5)

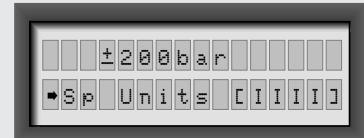

Range: 192 characters per position

Refer to section

13.2 Decimal Point.

Once the numerical value of the UPPER and LOWER display reading has been set – the decimal point can be TRAVERSED along to any desired position in the number.

Key  or  to TRAVERSE the decimal point.



Key  to CONFIRM.

13.3 Update.

The input signal is sampled at a pre-determined interval.

The value of an ANALOGUE signal is averaged and up-dated at periodic intervals and the up-date period is adjustable. A low setting will give rapid reaction to the input signal and higher settings may be entered where damping of a fluctuating input is necessary, or simply as a means of applying a delay to the input. This is particularly appropriate in electrically noisy environments.

- For maximum accuracy, sampling takes place at the front end, prior to pre-scaling.
- Analogue levels are AVERAGED between samples.
- Pulse frequencies are SAMPLED over a time period.

Key  or  to SCROLL the value.

Key  to CONFIRM.

13.4 & 13.5



Range: x 0.100000...100000.0

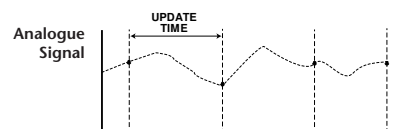

0...250 seconds

Refer to section

13. SCALE AND DISPLAY SETTINGS *continued*

13.4 Lower.

13.5 Upper.

Independently adjustable, these two parameters are closely inter-related.

They set the desired LOWER LIMIT and UPPER LIMIT of the display reading for a given input signal.

The 'range' of the display can be programmed to show 'true' unit values incorporating multiplication constants, zero offset values or negative values.

Key  to TRAVERSE the cursor along the digits.

Key  to SCROLL the digit with the cursor under.

Key  to CONFIRM.

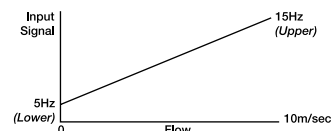
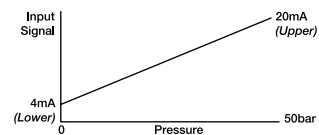

Range: ± .9999999

- The signal response between LOWER and UPPER will be assumed to be linear.
- Signals from non conforming devices such as thermocouples will be automatically linearised to the appropriate standard.
- Non linear relationships such as square law signals from DP sensors and polynomials can also be incorporated in software to specific requirements.

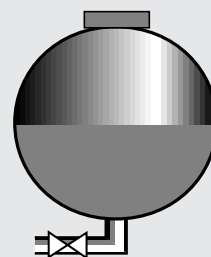

Refer to
section

14. SETPOINT CHARACTERISTICS

The Trip Amplifier has two SETPOINT output relays or alarm points R1 and R2 and the various operating characteristics of each can be individually determined.

Relays are normally *energised*, and *de-energised* when a setpoint is exceeded.

Key  or  to SCROLL the menu.

Key  to CONFIRM.



14.1 Level.

The operating LEVEL or setpoint of each RELAY can be set.

Key  to TRAVERSE the cursor along the digits.

Key  to SCROLL the value of the digit.

Key  to CONFIRM.





Range: 0...Full scale value

14.2 Hysteresis.

The Hysteresis is the DEADBAND between the relay switching OFF and switching ON at the SETPOINT, as the input signal rises and falls.

This can be set as a percentage of the SETPOINT LEVEL

Key  or  to SCROLL the value.

Key  to CONFIRM.



Range: 0...Full scale value

A low value of hysteresis, say 5%, is often used to override fluctuating signal levels and to prevent 'hunting' in closed-loop control systems.

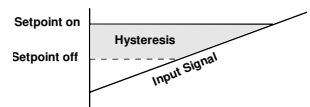

A high value of hysteresis can also be used as a control function as when controlling the operation of pumps. The pump will start at high level and continue pumping until low level is reached at the bottom of the hysteresis band.

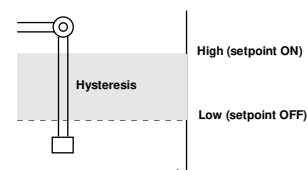

Refer to section

14. SETPOINT CHARACTERISTICS *continued*

14.3 Alarm (Rising/Falling).

The relays can be arranged to de-energise on a RISING input signal or a FALLING input signal.

For example, when monitoring excess vibration or high gas concentration, the relay can be set to de-energise on a RISING signal to give a failsafe alarm function. Conversely, when monitoring flow failure or low pressure, the relay can be set to de-energise on a FALLING signal.

Key  or  to SELECT RISING/FALLING.

Key  to CONFIRM.

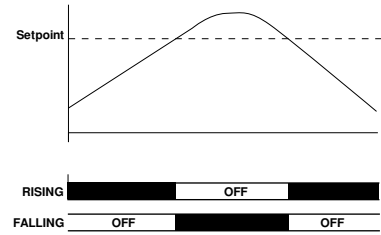

14.4 ON Delay.

The operation of the setpoint signal can be delayed by an adjustable time period. *t on*.

This is useful for alarm verification, to apply time delay in a process control action, or to override a spurious fluctuation of the input signal.

If the input signal falls below the setpoint before the programme time has elapsed, the timer will reset to zero ready to start again.

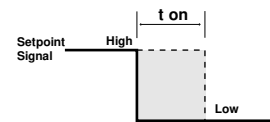

14.6

14.5 OFF Delay.

The resetting of the setpoint signal can also be delayed by an adjustable time period. *t off*.

If the input signal exceeds the setpoint before the programme time has elapsed, the timer will reset to zero, ready to start again.

Key  or  to SCROLL the value.

Key  to CONFIRM.



14.6

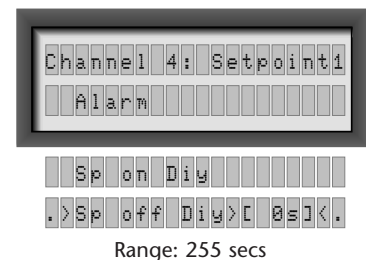

- Both the setpoint ON Delay and the setpoint OFF Delay can be combined, if required, and are independently programmable.



Refer to section

14.6 Operation.

The relay can be set to function in four different ways at its setpoint.

AUTO RESET

The relay will de-energise when the input signal *exceeds* the setpoint value and will reset when the input signal *recedes*.
t = Any delay that is programmed.

14.1/14.5

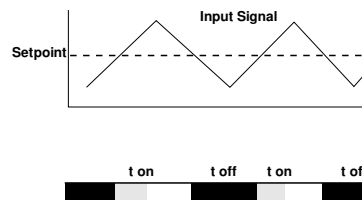

LATCH UNTIL RESET

The relay will de-energise when the input signal *exceeds* the setpoint value and *latch* until reset.
t = Any delay that is programmed.

14.1/14.5

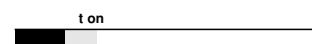

TOGGLE

The relay will energise/de-energise each time the setpoint value is *exceeded*.
t = Any delay that is programmed.

14.1/14.5

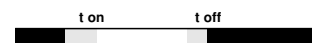

PULSE

The setpoint signal will give an impulse equal to time t_2 each time the setpoint value is *exceeded*.
t = Any delay that is programmed.

14.1/14.5



The commencement of the pulse will be delayed by a time equal to t_1 after the setpoint value is exceeded.

METHODS TO RESET	COUNT DISPLAY	LATCHED RELAY
0/1/0 Impulse on Input 2	✓	NA
0V Impulse on Terminal 11	✓	✓
Key and hold then then release	✓	✓
Temporarily remove the power supply	✓	✓

6.1

6.4

Key or to SCROLL the function.

Key to CONFIRM.



Refer to section

15. CONTRAST CONTROL

The contrast of the LCD can be varied to compensate for the effect of local ambient temperature conditions.

Key  or  to SET the contrast.

Key  to CONFIRM.



Range: 0...50
0 = Max contrast at 20°C

Refer to section

16. KEYCODE

All programming in the MAIN SETUP can be denied by a prescribed security code. It is a selectable option and the code can be changed at any time.

Key  to TRAVERSE the cursor along the digits.

Key  to CHANGE the value of the digit with the cursor under.

Key  to CONFIRM.

10.1



- = Keycode OFF (unrestricted access)

+ = Keycode ON (restricted access)

Range : 0...9999

Refer to section

18. APPROVALS

Electro Magnetic Compatibility.

The instrument is designed to comply with the requirement of the EC directive on EMC (89/336/EEC).



PROTECTING THE ENVIRONMENT

Many of our products are often used to monitor the quality of environmental conditions consequently Trolex is also particularly aware of the need to protect human health and the environment in which we live.

The Company has instituted a radical environment protection policy to ensure that all aspects of our manufacturing programme have the minimum possible detrimental impact on the environment. This covers all stages beginning with sustainable product design supported by careful selection of the materials used in their production, through to managed recovery and disposal at the end of the useful life of a product.

This policy also incorporates the principles of the Waste Electrical and Electronics Equipment (WEEE) directive, and the associated Restriction of Hazardous Substances (RoHS) directive, to be implemented in EU countries.

Progress is already well advanced on the introduction of a completely new range of products that maximise the central principle of sustainable design with the intention of reducing the end-of-life cost to the end user.

All Trolex products are manufactured to exacting standards in accordance with our stringent quality control ethos. Having chosen to use one of our products will, in itself, guarantee extended durability and a long operating life, endorsed by our commitment to recycling and recovery.

- All packaging materials are carefully selected to be bio-degradable or re-cycleable where possible.
- All plastic materials are identified for recycling purposes and re-cycled materials are used where it is possible to do so.
- Printing paper and material are sourced from suppliers that have a declared environmental management system.
- Product design centred around high quality and long term durability. Modular architecture both in construction and software design suitable for future upgrades and adaptability to alternative duty.
- Ease of product disassembly, minimisation of fixing devices, and clear separation of functional parts to benefit re-use and re-cycling.
- Control and monitoring of suppliers of components and sub-assemblies. Deal only with suppliers that have a defined commitment to environmental monitoring principles.
- Control the use of restricted substances within the design process. Deal only with suppliers that have a defined commitment to the control of restricted substances.
- Provide an efficient high speed service within Trolex for repair, refurbishing and conversion of products for alternative duty.
- Provision of an end-of-life product Take-back service for recovery, re-use, and recycling of electrical and electronic components. Retain the packaging of a new product and re-use it to return the device to us at the end of its working life. Trolex will guarantee to recover all materials and components, where practicable and arrange for them to be re-cycled in an appropriate and in a safe manner.

TROLEX LIMITED

Newby Road, Hazel Grove, Stockport, Cheshire SK7 5DY, UK.

Tel: +44 (0)161-483 1435 E-mail: sales@trolex.com

Internet: www.trolex.com

The above data is given for guidance only. It does not constitute a specification or an offer of sale. The products are always subject to a programme of improvement and testing which may result in some changes in the characteristics quoted.