

## Programmable Sensor Controller

Complete versatility of underground sensor management and data communications in arduous, industrial environments and hazardous areas

**Environments:** Mining • Tunnelling • Machine monitoring • Centralised monitoring and alarm systems

### Features

- Suitable for use in SIL 1 and SIL 2 applications, in accordance with defined conditions or restrictions
- Up to eight channels of analogue or digital inputs
  - 4 to 20 mA current input - SIL 1 & 2
  - 0.4 to 2 V voltage input - SIL 1 & 2
  - PT100 temperature input
  - ac input for vibration sensors
  - Strain gauge input for balanced bridge sensors
  - On/Off sensing switches
  - Frequency input for speed sensing
- Programme input and output functions directly using the keypad and review full information display and diagnostic data on the display
- Certified intrinsically safe for use in mining hazardous areas
- RS485 data protocol for integrating multi-point sensor collecting into mine wide systems



### Benefits

- Versatile, accepts analogue or digital inputs from gas sensors, flow sensors, pressure sensors, vibration monitoring, temperature devices, frequency inputs and digital sensors
- Direct fingertip programming of input and output functions with full information display and data communications for mine wide sensor collecting networks or local control and alarm monitoring
- Simple to use - just four keys to programme the TX9042 Programmable Sensor Controller, no special software and no software programming skills required
- Full functional compatibility with the entire range of Trolex sensors
- Up to 32 TX9042 can be connected to a single mine wide data system

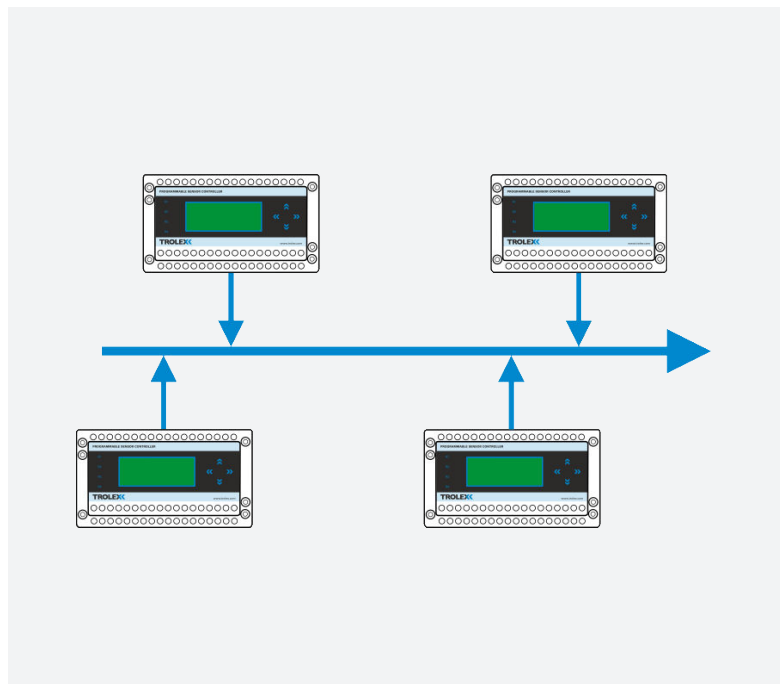

## Functional Overview

### Cost Effective Predictive Maintenance

- Up to 8 analogue sensors or process signals
- Up to 8 frequency or pulse inputs for counting, timing, speed sensing, etc
- Up to 16 On/Off or digital inputs, thermostats, limit switches, failsafe digital inputs, etc
- Easy to use menu selection for all display information including scale, offset, units and duty
- Four programmable output relays with adjustable setpoints, time delays, hysteresis, relay phase, latching and voting
- Simultaneous display of all input channels
- Individual input signal giving signal display, signal tendency, setpoint parameters and signal bar graph
- Data communication output ports for RS485
- Data logging facility, for up to 26,000 input readings per channel

### 8 Input Channels

- Any choice of analogue sensor, process signal or digital input
- Each channel function is determined by an interchangeable input module which can be selected for any desired functional combination
- Once in place, the module communicates directly with the central microprocessor to automatically format the operating characteristics of each channel

### Analogue Inputs

- Any of the 8 channels can be configured to accept a variety of analogue signal formats and will interface directly with Trolex sensors and most recognised sensor and process inputs
- Current Signals – 2 wire or 3 wire process signals. Fully floating differential input allows several units to be connected in series on the same loop with high noise immunity. 0 to 20 mA and 4 to 20 mA options
- Voltage Signals – Differential input enables long signal lines with minimal signal loss. 0 to 2 V, 0.4 to 2 V and 0 to 10 V options
- PT100 Input – Input standard for platinum resistance temperature sensors to DIN43760 and BS1904. -50 to +200°C and -50 to +400°C

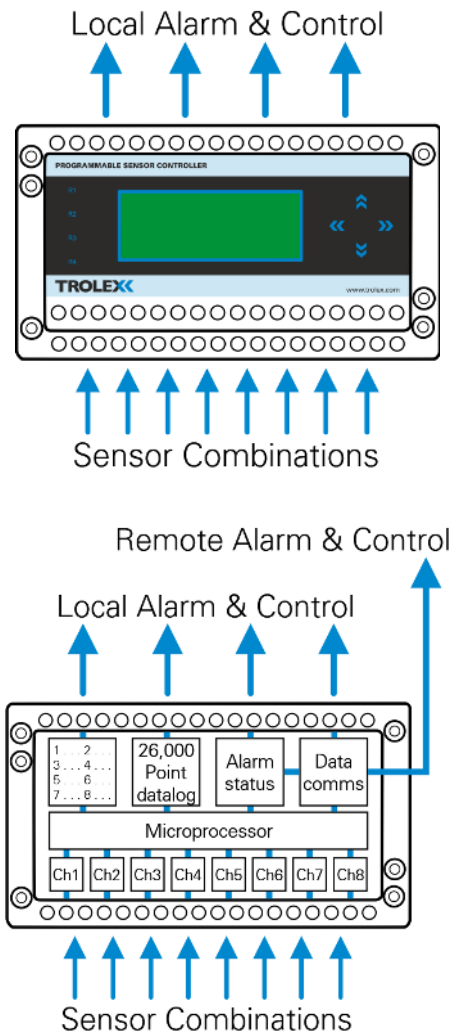

## Analogue Inputs - continued

- TX6023 Flow Sensor Inputs – Flow and pressure monitoring in pipelines on heavy mining machinery
- ac Input – ac input signals from load cells, ac generators, accelerometers and velocity sensors or power measurement systems. ac Peak: 10 Hz to 10 KHz 10 V pk/pk and ac RMS: 10 Hz to 10 KHz 10 V pk/pk options
- Bridge Input – Balanced four-arm bridge input. Bridge measuring circuits. Pressure sensors and strain gauges. 0.1 to 100 mV/V

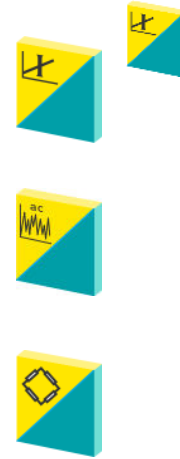

## Digital Inputs

- Any of the 8 channels can be configured to accept pulsing or frequency inputs from NAMUR proximity sensors or switches and each can be individually programmed by the user for seven different pulse processing functions. Input pulses can be prescaled by a selectable factor and the input threshold pulse acceptance level can be programmed to suit a particular application
- Input Signals – Voltage free contacts or photosensors and NAMUR sensors to DIN 19234 frequency range 0 to 10 KHz
- Pulse Count – Input pulse counting; single or continuous cycling, sequence counting, up counting, down counting and bi-directional counting
- Pulse Interval – Compares the interval between two consecutive pulses with a programmed time period
- Pulse Frequency – The rate of pulses or frequency is measured and compared as an absolute value

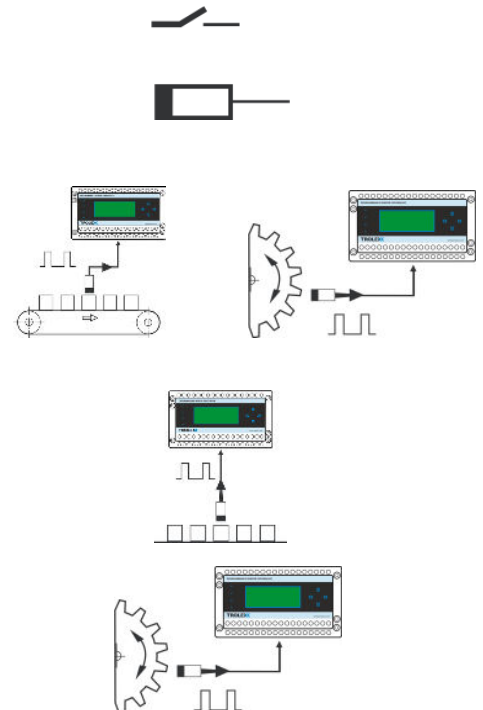

## Digital Inputs - continued

- Slip Frequency – The rate of pulses or frequency is measured and compared as a percentage slip value
- Differential Frequency – Two separate pulse sources are compared as absolute values
- Differential Slip Frequency – Two separate pulse sources are compared as a percentage slip value
- Digital Inputs – Simple On/Off inputs - dual input on each channel. Functions as two independent alarm control inputs or as two independent programmable timers
- Digital Level Input with Failsafe – Simple On/Off inputs with open circuit/short circuit sensor connection protection - dual input on each channel

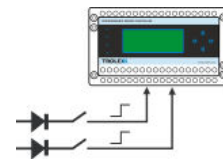
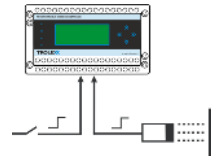
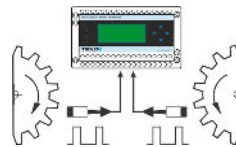
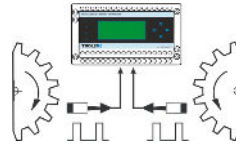
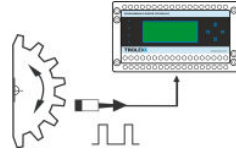

## Simple Programming

- Just four keys to programme the TX9042, no special software and no software programming skills required
- The TX9042 is packed with an amazingly versatile selection of operating functions – all fully programmable
  - Two setpoints per channel
  - Latching, auto reset, pulse or bi-stable relay operation
  - Hysteresis or relay deadband selection
  - Relay phase selection- rising alarm or falling alarm
  - Power on Delay to override machine run-up periods
  - Output relay Time Delay adjustment
  - Selectable input signal sampling rate or update time
  - Input signal pre-scaling
  - Signal span and offset adjustment
  - Engineering units menu for true value indication
  - Rising or falling signal tendency indication
  - Bar graph signal display
  - Last signal Peak or Low value data storage
  - Display space to enter specific input channel text



## Information Display

- All eight input signals are displayed simultaneously on the LCD panel showing the channel number and the signal level in each case. All channels are scanned continuously and the update period of each channel can be varied independently. Any individual channel can be selected to show close-up data about its input signal
- Channel Close-up Level 1 will show the channel number, the signal value with true engineering units, and the status of the two channel setpoints. Analogue signals will have a bar graph display to enable magnitude comparison and will show the periodic rising or falling tendency of the signal. Unique text about the channel can also be entered in the display relating to duty or information about the sensor
- Channel Close-up Level 2 will display stored information about the previous Peak and Minimum signal values together with the setpoint levels and a time clock/calender display

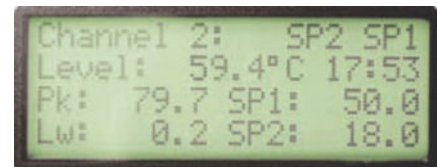
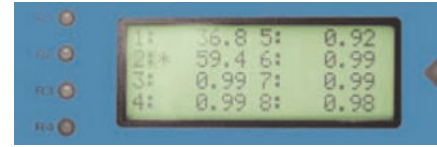

## Data Logging

- RS485 data communication and data logging are also included for recording historical information for up to 26,000 readings on each channel. The data shows the channel reference, with its value at the date and time recorded. The logging interval is user selectable. Rapid logging is possible to closely capture critical shutdown routines or a catastrophic plant failure. The information can be periodically reviewed or transferred on demand over the data communication link.

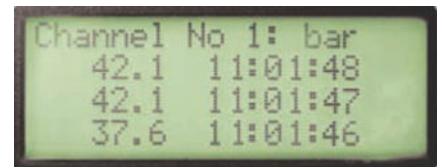

## Control Functions

- Each channel has two independent setpoint signals and an output for 'channel fault' indication. There are four independent setpoint output relays with LED status indicators and any of the channels or the fault signal can be assigned or networked to any of the output relays. This enables alarm status groupings, selective shutdown routines and elementary logic functions to be easily programmed

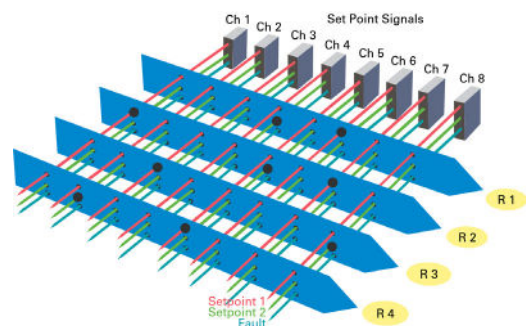

## Input Signal Fault Alarm

- An input signal failure or cable fault will drive the display Overscale or Underscale dependent upon the nature of the fault. This will result in Fault Signal Output and a Signal Error display on the appropriate channel. The operating integrity is also under constant surveillance by a self checking Watchdog system which gives a fault signal if a failure should occur



## Mine Wide Monitoring

- RS485 data protocol for integrating multi-point sensor collecting. Up to 32 TX9042's can be incorporated over a 1 km distance without repeaters. Transmission protocol is by MODBUS. Trolex system engineers can design fully integrated data collection networks, including the configuration of surface PC terminal graphic display packages

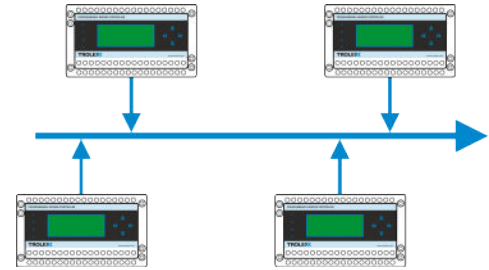

## Information Security

- All essential information can be protected by a user Security Code. This prevents the data from being corrupted by an unauthorised user but still permits access to day to day functions

## Technical Information

Display accuracy:	+/-0.25% (analogue channels)
Setpoint accuracy:	+/-0.5%
Ambient temperature limits:	-10 to +50°C
Electrical connections:	4 mm barrier/clamp terminals
Housing material:	ABS
Nett weight:	800 g
Environmental protection:	Must be housed in a protective metal enclosure to comply with Intrinsically Safe requirements
Information display:	LCD screen, 20 characters x 4 lines, 6 mm high characters
Mounting:	DIN rail
Microprocessor:	Microprocessor controlled menu operation, with non-volatile retention and 10 bit analogue to digital conversion (analogue channels)
Setpoints:	2 per channel plus Fault signal
Output relays:	4 encapsulated reed relays with function programming
Contact rating:	23 V, 0.25 A, 3 W maximum (intrinsically safe circuits only)
Setpoint adjustment:	0 to 99%
Hysteresis adjustment:	0 to 99%
Power on delay adjustment:	0 to 255 seconds for each channel
Output delay adjustment:	0 to 18 hours for each setpoint
Input update period adjustment:	0 to 60 seconds for each channel
Engineering units menu:	V, mV, mA, °C, °F, °K, g, kg, mbar, bar, Pa, kPa, PSI, %, ppm, %RH, mm, m, mm/s, m <sup>3</sup> /s, rpm, pps, Hz, kHz, secs, m:s, h:m, m/s, m <sup>3</sup> /H, m <sup>3</sup> /m, A, l/m, g/m, l/s, g/s, l/h and g/h
Fault signal:	Open or short circuit signal line or microprocessor watchdog alarm will generate a fault signal, the fault will be identified on the LCD screen
Data communications:	RS485
Data logging:	Up to 26,000 readings with on-demand down loading
Supply voltage:	12 V dc +20%/-2.5% @ 125 mA



## Dimensions

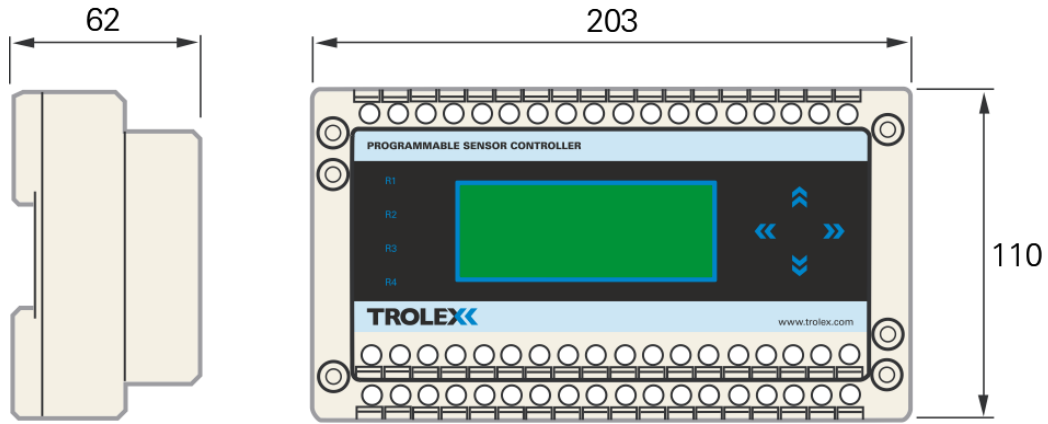

All dimensions in mm

## Electrical Connections

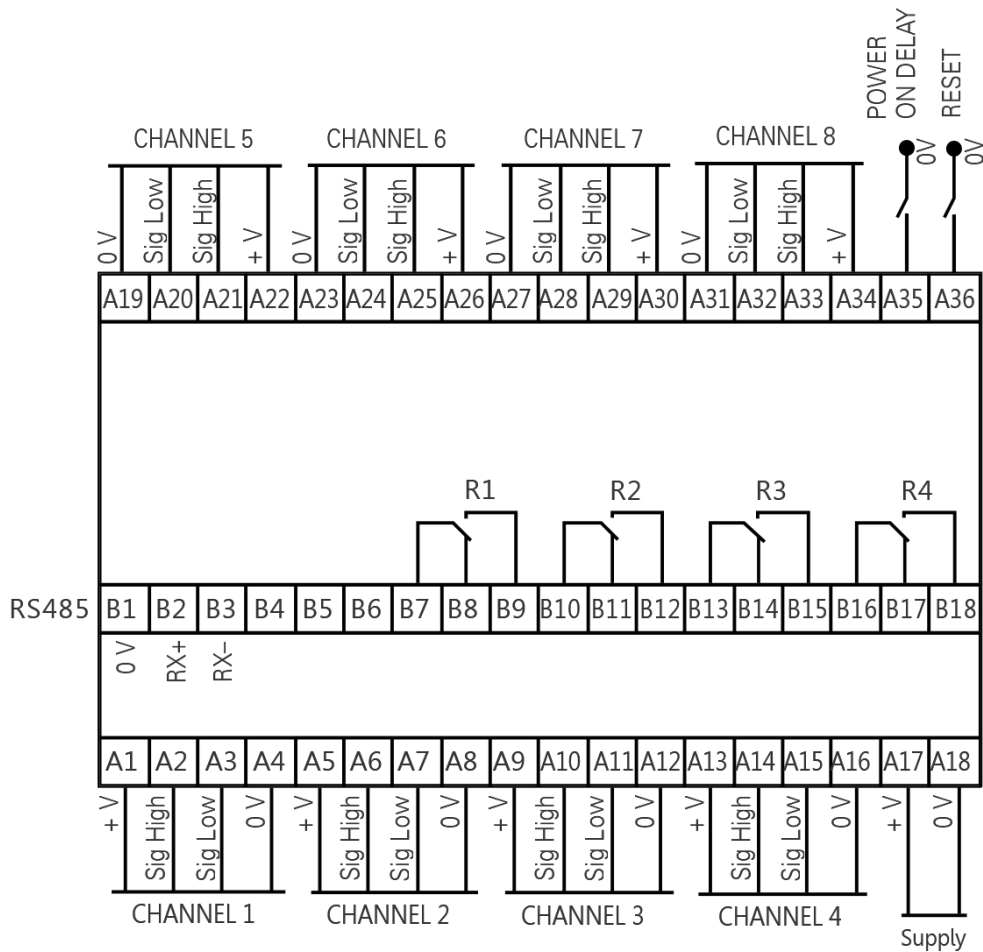

The output contacts are shown with the relays de-energised in the alarm condition

## Order Reference

### TX9042 Programmable Sensor Controller

Description	Order Code
	ATEX
8 Channel Programmable Sensor Controller	TX9042.55

## Module Options

When ordering, please specify the input modules required

### TX9042 Input Module Type

Input Module Description	Order Code
	ATEX
Current - 0 to 20 mA	P5423.516
Current - 4 to 20 mA - SIL 1 & 2	P5423.508
Voltage - 0 to 2 V	P5423.514
Voltage - 0.4 to 2 V - SIL 1 & 2	P5423.509
Voltage - 0 to 10 V	P5423.515
Flow TX6023 - not Io limited *	P5423.552
Flow TX6023 - Io limited	P5423.553
Flow TX6023 - 4 to 20 mA Io limited	P5423.556
PT100 - -50 to +200°C	P5423.510
PT100 - -50 to +400°C	P5423.513
Flow TX6022 - Flow	P5423.528
Flow TX6022 - Pressure	P5423.518
ac RMS - 500 Hz to 10 kHz - TX5630	P5423.506.01
ac RMS - 15 to 100 Hz - TX5630	P5423.506.02

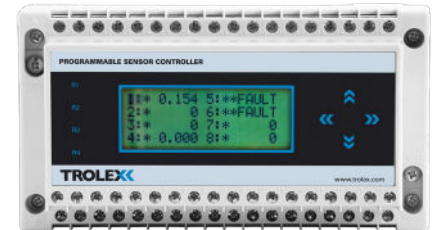



## Module Options - continued

When ordering, please specify the input modules required

### TX9042 Input Module Type

Input Module Description	Order Code ATEX
Digital - 12/24 V	P5423.523
Digital - Fail Safe	P5423.522
Digital - Vortex	P5423.524
Strain Gauge - 2 mV/V	P5423.520.01
Strain Gauge - 3 mV/V	P5423.520.02
Strain Gauge - 10 mV/V	P5423.520.03
Strain Gauge - 50 mV/V	P5423.520.04
Strain Gauge - 100 mV/V	P5423.520.05

\* May be used in conjunction with P5546.18 Interface Unit.

## Accessories

TX9204          Housing - accommodates one TX9042

Please contact the Trolex Sales Team for further information and advice:

+44 (0)161 483 1435  
sales@trolex.com



## Certifications

For full certification details please refer to the User Manual

---

## Copyright and Trademarks

© 2015 Trolex® Limited. Trolex is a registered trademark of Trolex Limited. The use of all trademarks in this document is acknowledged.

Document history:	Issue 03	04/09/2014
	Issue 04	03/06/2015
	Rev A	13/03/2024

### Trolex Limited

Newby Road, Hazel Grove, Stockport, Cheshire SK7 5DY, United Kingdom  
+44 (0)161 483 1435 sales@trolex.com www.trolex.com

