

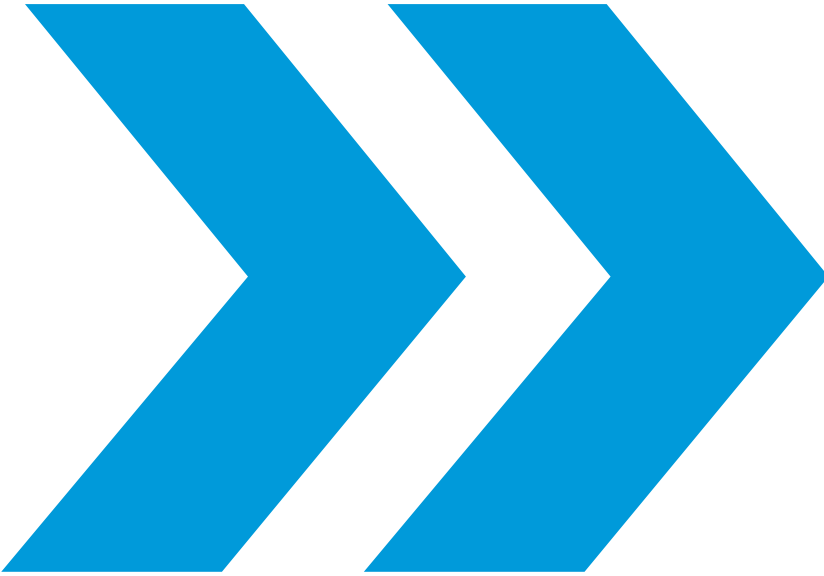

**TX6351 • TX6352**  
**Sentro 1 Universal Gas Detector**



# User Manual



# TX6351 • TX6352 Sentro 1 Universal Gas Detector

## Contents

<b>1. Product Overview</b>	<b>4</b>	<b>4. Setup and Calibration</b>	<b>31</b>
1.1 Operating Features	4	4.1 Controls and Indicators	31
1.2 Application	5	4.2 Main Display	33
1.3 Product Options	5	4.3 Security Code Access	34
1.4 Dimensions	6	4.4 Main Menu	35
1.5 Technical Information	7	4.4.1 Calibrate	36
1.6 Electrical Details	9	4.4.2 Sentro 1 Setup	39
1.7 Sentro eModules	11	4.4.3 Output Setup	41
<b>2. Certification</b>	<b>18</b>	4.4.4 Modbus	44
2.1 Newer Sentro 1 Models with Red Labels (designated .35)	18	4.4.5 Module Setup	44
2.2 Older Sentro 1 Models with Yellow Labels (not designated .35)	20	4.4.6 Support	47
<b>3. Installation</b>	<b>23</b>	<b>5. Diagnostics and Maintenance</b>	<b>48</b>
3.1 Safety Precautions	20	5.1 Diagnostic Messages	48
3.2 Tools and Test Equipment Required	24	5.2 Maintenance	49
3.3 Siting Recommendations	25	5.3 Maintenance and Calibration Log	52
3.4 Connections	26	5.4 Disposal	53
3.4.1 0.4 to 2 V / 2 to 10 V Analogue Output Signal	26	<b>Disclaimers</b>	<b>53</b>
3.4.2 4 to 20 mA Analogue Output Signal	27	<b>Trademarks</b>	<b>54</b>
3.4.4 Contact Output Signal	28	<b>Contact Details</b>	<b>54</b>
3.4.5 RS485 Data Output Signal	29	<b>Document History</b>	<b>54</b>
3.5 Connecting in Hazardous Areas	30		

# 1. Product Overview



<b>TX6351</b>	3/4 wire device with separate output signal and power lines. Can be used with any Sentro eModule
<b>TX6352</b>	2-wire line powered 4 to 20 mA output signal. Can ONLY be used with electrochemical Sentro eModules

## 1.1 Operating Features



- Fixed sensor for detection of Toxic Gases and Flammable Gases
- Exclusive pre-calibrated plug-in gas sensing modules for many types of gas
- LCD readout and visual LED alarm indicators
- Choice of output signal format
- Heavy duty housing to IP65
- EMC compliant
- STEL and TWA monitoring for selected gases

## 1.2 Application

Fixed point gas detection for safety monitoring in hazardous areas and general purpose applications.

<p><b>Underground Mining and Tunnelling</b> <b>Ex ia I Ma</b></p> <p>TX6351.01i TX6352.01i</p>	<p><b>Supply Voltage:</b> 12 V dc from an approved power source</p> <p><b>Type of protection:</b> Intrinsically safe. Ex ia</p> <p><b>Category:</b> I M1</p>
<p><b>General Purpose</b> TX6351.03 TX6352.03</p>	<p><b>Supply Voltage:</b> 24 V dc</p>

## 1.3 Product Options

		<b>Mining Ex ia</b>		Certification (older models with yellow labels) 		Certification (newer models with red labels) 	
		Four-wire connection					
<b>TX6351.01i</b>	0.4 - 2.0 V dc	.11	IECEX (AUS) Grpl	.06	MASC/IECEX Grpl	.35.05	
	4 - 20 mA	.12	EAC Grpl	.14	ATEX/IECEX/UKEX Grpl	.35.19	
	Dual Relay NC	.14	ATEX/IECEX Grpl	.19			
	Dual Relay NO	.17	MASC Grpl	.05			
	RS-485	.15					
		Two-wire line powered					
<b>TX6352.01i</b>	4 - 20 mA loop	.12					

		<b>General Purpose</b>	
		Four-wire connection	Button configuration
<b>TX6351.03.00</b>	4-20mA	.12	Internal buttons .01
	Dual Relay NC	.14	External buttons .02
	Dual Relay NO	.17	
	RS-485	.15	
	2-10Vdc	.16	
		Two-wire line powered	
<b>TX6352.03.00</b>	4 - 20 mA	.12	

## 1.4 Dimensions

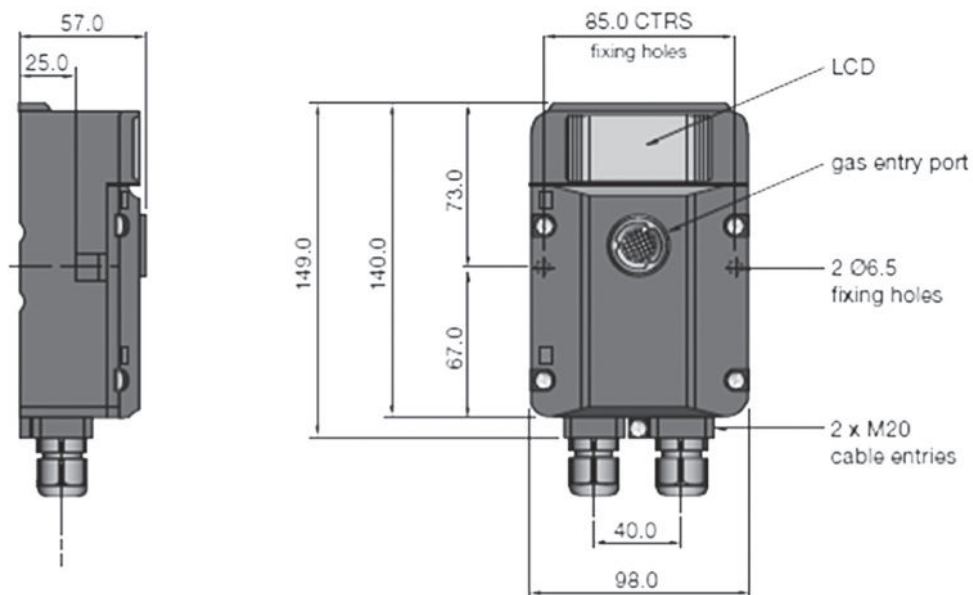

## 1.5 Technical Information





Ambient temperature limits	-20 to +40 °C
Storage temperature	-20 to +60 °C
Ambient pressure	800 to 1100 mbar
Humidity	15 % to 90 % non-condensing
Protection classification	Dust and waterproof to IP65. Gas Port: IP54.
Housing material	Reinforced polymer with static charge dissipation
Nett weight	530 g
Cable entries	2 x M20
Electrical connections	4 mm barrier/clamp terminals
Conductors	A maximum of two per terminal
Conductor size	A maximum of 2.5 mm <sup>2</sup>
Terminal torque	2.4 Nm maximum
Information display	128 x 64 dot graphic backlit LCD
Vibration limits	Vibration limits (IEC 60079-29-1): <ul style="list-style-type: none"> <li>• 10 to 30 Hz - 1.00 mm total excursion</li> <li>• 31 to 150 Hz - 19.6 m/s<sup>2</sup> acceleration peak</li> </ul>
Impact limits	20 joules (housing)
Calibration and setup	Digitally controlled ZERO and SPAN pushbutton setting
Signal fix	The analogue output signal of the sensor is fixed during calibration to prevent false alarms from being initiated
Fault indication	Under range signal transmitted and fault display for: <ul style="list-style-type: none"> <li>• Loss of communications from the sensing module</li> <li>• Sensing module absent for more than 10 seconds</li> <li>• Sensor over-range protect</li> </ul>
Key coding	Coding stops prevent insertion of a non-valid sensing module.

Alarms	<p>Programmable GENERAL alarms and HIGH alarms with an LED indicator.</p> <p>The two adjustable alarm setpoints are preset during manufacture to default values appropriate to the type of sensor, determined by the sensing module being used.</p>
STEL and TWA	<p>Automatic setting of STEL and TWA limits to EH40 standards.</p> <p>STEL: Exposure over 15-minute successive periods</p> <p>TWA: Exposure over a continuous rolling 8-hour period</p>
Output signals	<p>0.4 to 2 V / 2 to 10 V</p> <p>4 to 20 mA</p> <p>Dual relay contacts. NO or NC to specification</p> <p>RS485 Modbus datacomms</p>







## 1.6 Electrical Details

### General Purpose

TX6351	3/4 wire. Remote powered 4 to 20 mA analogue output	
Supply voltage:	18 to 28 V	
Max. line load:	500 Ω at 24 V	
Type of sensor:	Toxic	Flammable      Infrared
Supply current:	40 mA	40 mA      60 mA
TX6351	3/4 wire. Remote powered Dual output contacts NC/NO	
Supply voltage:	20 to 28 V	
Type of sensor:	Toxic	Flammable      Infrared
Supply current:	35 mA	45 mA      60 mA
TX6351	3/4 wire. Remote powered RS485 datacomms output	
Supply voltage:	14 to 28 V	
Line:	Modbus protocol	
Type of sensor:	Toxic	Flammable      Infrared
Supply current:	40 mA	40 mA      60 mA
TX6352	2 wire. Line powered 4 to 20 mA analogue output	
Supply voltage:	18 to 28 V	
Max. Line Load:	300 Ω	
Type of Sensor:	Toxic only	
TX6351	3/4 wire. Remote powered 2 to 10 V analogue output	
Supply voltage:	14 to 28 V	
Minimum line load:	10 KΩ	
Type of sensor:	Toxic	Flammable      Infrared
Supply current @ 24 V:	20 mA	60 mA      80 mA

## Mining and Tunnelling

TX6351	3/4 wire. Remote powered 4 to 20 mA analogue output			
Supply voltage:	10 to 14 V			
Max. line load:	220 Ω maximum @ 12 V dc			
Type of sensor:	Toxic	Flammable	Infrared	
Supply current @ 12 V:	48 mA	70 mA	91 mA	
TX6351	3/4 wire. Remote powered Dual output contacts NC/NO			
Supply voltage:	10 to 14 V			
Type of sensor:	Toxic	Flammable	Infrared	
Supply current @ 12 V:	60 mA	85 mA	105 mA	
TX6351	3/4 wire. Remote powered RS485 datacomms output			
Supply voltage:	10 to 14 V			
Line:	Modbus protocol			
Type of sensor:	Toxic	Flammable	Infrared	
Supply current @ 12 V:	25 mA	60 mA	80 mA	
TX6351	3/4 wire. Remote powered 0.4 to 2 V analogue output			
Supply voltage:	10 to 14 V			
Min. line load:	10 KΩ			
Type of sensor:	Toxic	Flammable	Infrared	
Supply current @ 12 V:	20 mA	60 mA	80 mA	
TX6352	2 wire. Line powered 4 to 20 mA analogue output			
Supply voltage:	10 to 14 V			
Max. line load:	90 Ω			
Type of sensor:	Toxic only			

## 1.7 Sentro eModules

Plug-in pre-calibrated modules with standardised output data.



- Each module stores all the necessary data about its type identification, sensing range and specific calibration. This data is automatically recognised by Sentro when the module is loaded into the module bay.
- The modules are pre-calibrated so can be substituted at any time by a replacement module – usually of the same type, but an alternative may be inserted if required.
- Insert coding stops to prevent non-valid module combinations.
- The sensing module will identify itself when plugged into the sensor housing and auto configuration will take place.
- All Sentro Modules have two output alarm signals for GENERAL alarm and HIGH alarm. Default values are entered during manufacture and these can be changed to preferred values.
- The alarm signals can be set to illuminate built-in flashing LED indicators.
- The signals can operate the two GENERAL alarm and HIGH alarm relays on the CONTACT OUTPUT version of Sentro 1.
- Service replacement modules can be specified using the appropriate gas type code from the eModule order reference table on the datasheet
- The order reference is also marked on the back of the eModules.
- **The order reference may vary for some eModules dependent upon the year of manufacture of the base unit:**

### eModules for Base Units with Yellow Certification Label

ATEX/IECEX Grpl	TX6350.01.	Gas Type
MASC Grpl	TX6350.05.	Gas Type
IECEX (AUS) Grpl	TX6350.06.	Gas Type
EAC Grpl	TX6350.14.	Gas Type



### eModules for Base Units with Red Certification Label

ATEX/IECEX/UKEX Grpl	TX6350.35.19.	Gas Type
MASC/IECEX Grpl	TX6350.35.05.	Gas Type



## Flammable gases • Poison resistant catalytic sensor

INDICATIVE VALUES ONLY, OTHER RANGES AND CALIBRATIONS CAN BE SUPPLIED TO SPECIFICATION

The sensor can be configured to respond to many flammable gases and vapours. It is usual to calibrate to methane in terms of %LEL or %volume.



### Section 4.4.5 >>

TX6350	.240	.246	.244
	Methane CH <sub>4</sub>	Methane CH <sub>4</sub>	Methane CH <sub>4</sub>
<b>Sensing element</b>	Poison resistant pellistor with active temperature compensation		
<b>Sensing range</b>	0 to 100% LEL based on 4.4%v/v	0 to 4% v/v	0 to 5% v/v
<b>Linearity</b>	Linear up to 3% v/v	3% to 5% ±0.25%	
<b>Max. Drift @ 25°C</b>	±0.25% CH <sub>4</sub> v/v per month		
<b>*Response time t(63)</b>	<15 secs		
<b>*Response time t(90)</b>	<20 secs		
<b>Sensing element life</b>	>5 years in clean atmosphere		
<b>Warm up time</b>	<5 mins in air or 1% v/v CH <sub>4</sub>		
<b>Stabilisation time</b>	≥15 mins		
<b>GENERAL alarm</b>	10% LEL (.240)	0.40% (.246)	0.50% (.244)
<b>HIGH alarm</b>	25% LEL (.240)	1.00% (.246)	1.25% (.244)

\* Response times are tested by flowing test gas using the calibration kit referred to in section 5.2 Maintenance.

#### Checkpoint

Not suitable for use with the TX6352 4 to 20 mA two wire, line powered version of Sentro.

#### Checkpoint

The pellistor is automatically protected against exposure to excessively high concentrations of gas.

**Toxic gases • Electrochemical cells**

INDICATIVE VALUES ONLY, OTHER RANGES AND CALIBRATIONS CAN BE SUPPLIED TO SPECIFICATION



Selected toxic gas modules are equipped with automatic STEL/TWA calculation in accordance with EH40.

**Section 4.4.5**

TX6350	.250.50	.250.250	.250.300	.250.500	.251	.252
	Carbon Monoxide CO	Carbon Monoxide CO	Carbon Monoxide CO	Carbon Monoxide CO	Hydrogen Sulphide H <sub>2</sub> S	Sulphur Dioxide SO <sub>2</sub>
<b>Sensing element</b>	Electrochemical cell					
<b>Sensing range</b>	0 to 50 ppm	0 to 250 ppm	0 to 300 ppm	0 to 500 ppm	0 to 50 ppm	0 to 20 ppm
<b>Linearity</b>	±2% FS					
<b>Drift</b>	2% per month					
<b>Repeatability</b>	±2%					
<b>*Response time t(90)</b>	<30 secs				<45 secs	<30 secs
<b>Operating life</b>	2 years					
<b>Relative humidity</b>	15 to 90% non-condensing					
<b>Operating temperature</b>	-10 to +40°C					
<b>GENERAL alarm</b>	18 ppm	38 ppm	45 ppm	75 ppm	8 ppm	3 ppm
<b>HIGH alarm</b>	15 ppm	75ppm	90 ppm	150 ppm	15 ppm	6 ppm
<b>STEL &amp; TWA</b>	200 ppm 30 ppm	200 ppm 30 ppm	200 ppm 30 ppm	200 ppm 30 ppm	10 ppm 5 ppm	1 ppm 0.5 ppm

\* Response times are tested by flowing test gas using the calibration kit referred to in section 5.2 Maintenance.

## Toxic gases • Electrochemical cells - continued

INDICATIVE VALUES ONLY, OTHER RANGES AND CALIBRATIONS CAN BE SUPPLIED TO SPECIFICATION

Selected toxic gas modules are equipped with automatic STEL/TWA calculation in accordance with EH40.



### Section 4.4.5 >>

<b>TX6350</b>	<b>.254</b> Nitrogen Dioxide NO <sub>2</sub>	<b>.254.10</b> Nitrogen Dioxide NO <sub>2</sub>	<b>.257</b> Oxygen O <sub>2</sub>	<b>.259</b> Nitric Oxide NO	<b>.261</b> Hydrogen H <sub>2</sub>
<b>Sensing element</b>	Electrochemical Cell				
<b>Sensing range</b>	0 to 20 ppm	0 to 10 ppm	0 to 25%	0 to 50 ppm	0 to 1000 ppm
<b>Linearity</b>	±2% FS		±0.3% vol	±5% FS	±2% FS
<b>Drift</b>	2% per month		10% per year	2% per month	
<b>Repeatability</b>	±2%				
<b>*Response time t(63)</b>	<20 secs		N/A	<20 secs	N/A
<b>*Response time t(90)</b>	<30 secs		<60 secs	<30 secs	<90 secs
<b>Operating life</b>	2 years		2 years	2 years	
<b>Relative humidity</b>	15 to 90% non-condensing				
<b>Operating temperature</b>	-10 to +40°C				
<b>GENERAL alarm</b>	3 ppm	1.5 ppm	19% (under)	8 ppm	150 ppm
<b>HIGH alarm</b>	6 ppm	3 ppm	23% (over)	15 ppm	300 ppm
<b>STEL &amp; TWA</b>	1 ppm 0.5 ppm	1 ppm 0.5 ppm	N/A N/A	10 ppm 25 ppm	N/A N/A

\* Response times are tested by flowing test gas using the calibration kit referred to in section 5.2 Maintenance.

## Checkpoint

Toxic gas Sentro eModules have a very low power consumption, enabling 4 to 20 mA two wire TX6352 line-powered version of Sentro to be used.

## Checkpoint

All values listed are nominal and slight variations may occur depending upon operating conditions.

- The natural level of oxygen available in the atmosphere is influenced by relative humidity and temperature. The oxygen sensor will react to these changes.
- Sudden changes in atmospheric pressure will also cause temporary instability in electrochemical sensors which may exceed 60 seconds.
- Long periods of use in extremely high or low humidity may affect the response of the sensor and shorten the life of electrochemical sensors.
- Nitric oxide sensors must be continuously powered to maintain calibration stability. If power has been absent for more than 10 minutes, it may take 24-48 hours for the sensor to restore stability. Do not calibrate until the output signal is steady.
- The presence of high levels of carbon dioxide (over 5%) may have a minor effect on the accuracy of the oxygen sensor.

## Checkpoint

Periodic calibration of the gas sensor should be carried out whilst it is in service. For oxygen and carbon monoxide gas sensors Trolex recommends that this is carried out every three weeks. For other gas sensors Trolex recommends that this is carried out in accordance with best practice for the industry where the gas sensor is being used, and should take into consideration local operating conditions.

## Carbon Dioxide/Methane Gases • Infrared sensor

INDICATIVE VALUES ONLY, OTHER RANGES AND CALIBRATIONS CAN BE SUPPLIED TO SPECIFICATION



The sensor is highly specific to the selected gas and exhibits consistent sensing accuracy with superior long-term stability.

The linear response means that it can be calibrated for low gas concentrations and high concentrations up to 100% by volume.

<b>TX6350</b>	<b>.243</b>	<b>.245</b>	<b>.242</b>	<b>.278.2</b>	<b>.278</b>	<b>.279</b>
	Methane CH <sub>4</sub>	Methane CH <sub>4</sub>	Methane CH <sub>4</sub>	Carbon Dioxide CO <sub>2</sub>	Carbon Dioxide CO <sub>2</sub>	Carbon Dioxide CO <sub>2</sub>
<b>Sensing element</b>	Infrared					
<b>Sensing range</b>	0 to 5% v/v	0 to 100% LEL	0 to 100% v/v	0 to 2% v/v	0 to 5% v/v	0 to 100% v/v
<b>Zero drift</b>	±0.05% v/v per month	±1% LEL per month	±0.5% v/v per month	±0.05% v/v per month		±1% v/v per month
<b>Repeatability</b>	±0.1% v/v	±2% LEL	±2% v/v	±0.05% v/v		±2% v/v
<b>*Response time t(63)</b>	<15 secs					
<b>*Response time t(90)</b>	<30 secs					
<b>Operating life</b>	<5 years					
<b>Relative humidity</b>	15 to 90% non-condensing					
<b>Operating temperature</b>	-10 to +40°C					
<b>GENERAL alarm</b>	0.5% v/v	10% LEL	10% v/v	0.3% v/v	0.75% v/v	15% v/v
<b>HIGH alarm</b>	1.25% v/v	25% LEL	25% v/v	0.6% v/v	1.5% v/v	30% v/v

\* Response times are tested by flowing test gas using the calibration kit referred to in section 5.2 Maintenance.



### **Checkpoint - Carbon Dioxide Sensors**

Normal atmosphere contains carbon dioxide which will affect the sensor signal so nitrogen gas must be used to accurately calibrate the zero value. Power should be applied to the sensor and the nitrogen applied for at least 5 minutes to ensure that the sensor has stabilised.

### **Checkpoint**

Not suitable for use with the TX6352 4 to 20 mA two wire, line powered version of Sentro 1.

## 2. Certification and Conformity

### 2.1. Newer Sentro 1 models with red label (designated .35)

	ATEX certification for use in underground mines (Group I) in European Union. Complies with ATEX Directive 2014/34/EU.
	Standards: EN IEC 60079-0:2018 EN 60079-11:2012

	UKEX certification for use in underground mines (Group I) in Great Britain (England, Scotland and Wales). Complies with UK Regulations 2016 S.I. 2016/1107
	Standards: EN IEC 60079-0:2018 EN 60079-11:2012

	IECEx (International) certification for use in underground mines (Group I).
	Standards: IEC 60079-0:2017 IEC 60079-11:2011

	MASC IA certification for use in underground mines (Group I) in South Africa.
	Standards: IEC 60079-0:2017 IEC 60079-11:2011

# TX6351 • TX6352 User Manual

Product Code:	Ex Certificate Number:	Ex Certification Code:
TX6351.01i.xx.35.19 Sentro 1	CML 20ATEX2271X IECEx CML 20.0158X CML 21UKEX2323X	I M1 Ex ia I Ma -20 °C ≤ Ta ≤ +40 °C
TX6352.01i.12.35.19 Sentro 1		
TX6351.01i.xx.35.05 Sentro 1	MASC M/21-8496 X IECEx CML 20.0158X	Ex ia I Ma -20 °C ≤ Ta ≤ +40 °C
TX6352.01i.12.35.05 Sentro 1		

The following Safety Description applies to the equipment listed above:

Model No.	Power Input	Output type	Output						
TX6351.01i.11.35	Terminal 5 w.r.t. 6 Ui = 14.4V Ci = 0 Li = 0	0.4V – 2V	Terminal 1 w.r.t. 2 or 3 Ui = 14.4V Uo = 14.4V Io = 40mA Po = 0.135W Ci = 0 Li = 0						
TX6351.01i.12.35		4mA – 20mA	Terminal 1 w.r.t. 2 or 3 Ui = 14.4V Uo = 14.4V Io = 0.477A Po = 1.72W Ci = 0 Li = 0						
TX6351.01i.15.35		RS485	Terminal 1 w.r.t. 3 (RS485 A) Terminal 2 w.r.t. 3 (RS485 B) Parameters for each output: <table border="1" style="display: inline-table; vertical-align: middle;"> <tr> <td>Ui = 6.88 V</td> <td>Uo = 5.88 V</td> </tr> <tr> <td>Ci = 0</td> <td>Io = 66 mA</td> </tr> <tr> <td>Li = 0</td> <td>Po = 97 mW</td> </tr> </table>	Ui = 6.88 V	Uo = 5.88 V	Ci = 0	Io = 66 mA	Li = 0	Po = 97 mW
Ui = 6.88 V		Uo = 5.88 V							
Ci = 0		Io = 66 mA							
Li = 0		Po = 97 mW							
TX6351.01i.14.35	Relays NC	Terminal 1 w.r.t. 2 (Relay 1) Terminal 3 w.r.t. 4 (Relay 2) <table border="1" style="display: inline-table; vertical-align: middle;"> <tr> <td>Ui = 30 V</td> <td>Uo = 0</td> </tr> <tr> <td>Ci = 0</td> <td>Io = 0</td> </tr> <tr> <td>Li = 0</td> <td>Po = 0</td> </tr> </table>	Ui = 30 V	Uo = 0	Ci = 0	Io = 0	Li = 0	Po = 0	
Ui = 30 V	Uo = 0								
Ci = 0	Io = 0								
Li = 0	Po = 0								
TX6351.01i.17.35	Relays NO	Terminal 1 w.r.t. 2 (Relay 1) Terminal 3 w.r.t. 4 (Relay 2) <table border="1" style="display: inline-table; vertical-align: middle;"> <tr> <td>Ui = 30 V</td> <td>Uo = 0</td> </tr> <tr> <td>Ci = 0</td> <td>Io = 0</td> </tr> <tr> <td>Li = 0</td> <td>Po = 0</td> </tr> </table>	Ui = 30 V	Uo = 0	Ci = 0	Io = 0	Li = 0	Po = 0	
Ui = 30 V	Uo = 0								
Ci = 0	Io = 0								
Li = 0	Po = 0								
TX6352.01i.12.35	Terminal 1 w.r.t. 2 Ui = 14.4V Ci = 0 Li = 0	Loop powered	N/A						

**The following Specific Conditions of Use apply to the certificates listed above:**

- The cable entries to the supply and output terminals shall be made via cable glands which provide a minimum degree of protection of IP54.
- Under certain extreme circumstances, unearthed metal parts of the enclosure may store an ignition-capable level of electrostatic charge. The equipment shall either be earthed via the integral earthing terminal or the user/installer shall implement precautions to prevent the build-up of electrostatic charge. When not earthed, the capacitance of the metallic label to earth is >10pF.

**2.2 Older Sentro 1 models with yellow label (not designated .35)**

	<p>ATEX certification for use in underground mines (Group I) in European Union. Complies with ATEX Directive 2014/34/EU.</p> <p>Standards: EN 60079-0:2012 EN 60079-11:2012</p>
---	---

	<p>IECEx (International) certification for use in underground mines (Group I) in Australia (including New South Wales) and New Zealand.</p> <p>Standards: IEC 60079-0:2011 IEC 60079-11:2011</p>
---	--

	<p>EAC certification for use in underground mines (Group I) in Eurasian Customs Union (including Russia).</p> <p>Standards: ГОСТ 31610.0-2014 (IEC 60079-0:2011) ГОСТ IEC 60079-1:2013 ГОСТ 31610.11-2014 (IEC 60079-11:2011) ГОСТ МЭК 60079-25-2012</p>
--	--

	<p>MASC IA certification for use in underground mines (Group I) in South Africa.</p> <p>Standards: SANS (IEC) 60079-0:2012 SANS (IEC) 60079-11:2012</p>
---	---

Product Code:	Ex Certificate Number:	Ex Certification Code:
TX6351.01i.xx.19 Sentro 1	Sira 09ATEX2352X IECEx SIR 09.0147X	I M1 Ex ia I Ma -20 °C ≤ Ta ≤ +40 °C
TX6352.01i.12.19 Sentro 1		
TX6351.01i.xx.06 Sentro 1	IECEx ITA 14.0006X	Ex ia I Ma -20 °C ≤ Ta ≤ +40 °C
TX6352.01i.12.06 Sentro 1		
TX6351.01i.xx.06 Sentro 1	RU C-GB.AA87.B.0015819	PO Ex ia I Ma X -10 °C ≤ Ta ≤ +40 °C
TX6352.01i.12.06 Sentro 1		
TX6351.01i.xx.05 Sentro 1	MASC M/11-419X	Ex ia I Ma -20 °C ≤ Ta ≤ +40 °C
TX6352.01i.12.05 Sentro 1		

The following Specific Conditions of Use apply to the IECEx ITA 14.0006X certificate:

- The following safety parameters are applicable to the Sentro 1 Sensors/Transmitters:

Model	Terminals	Input Parameters					Output Parameters				
		U <sub>i</sub>	I <sub>i</sub>	P <sub>i</sub>	C <sub>i</sub>	L <sub>i</sub>	U <sub>o</sub>	I <sub>o</sub>	P <sub>o</sub>	C <sub>o</sub>	Lo*5
TX6351.01i.11	5 wrt 6	14.4V	*1	-	*2	*3	-	-	-	-	-
	1 wrt (2 or 3)	-	-	-	-	-	14.4V	40mA	135mW	*4	292mH
TX6351.01i.12	5 wrt 6	14.4V	*1	-	*2	*3	-	-	-	-	-
	1 wrt (2 or 3)	-	-	-	-	-	14.4V	447mA	1.72W	*4	2.1mH
TX6351.01i.15	5 wrt 6	14.4V	*1	-	*2	*3	-	-	-	-	-
	1 wrt 2 2 wrt 3	6.88V	*1	-	0	0	5.88V	66mA	97mW	*4	26mH
TX6351.01i.14 TX6351.01i.17	5 wrt 6	14.4V	*1	-	*2	*3	-	-	-	-	-
	1 wrt 2	30V	*1	-	0	0	0	0	0	0	0
	3 wrt 4	30V	*1	-	0	0	0	0	0	0	0
TX6352.01i.12	1 wrt 2	14.4V	*1	-	*2	*3	-	-	-	0	0

\*1 – I<sub>i</sub> Not critical

\*2 – C<sub>i</sub> C<sub>i</sub> = 0, unless a rModule is connected to the Sentro 1, then C<sub>i</sub>=0.38uF plus the C<sub>i</sub>

of the external sensors connected to the rModule.

\*3 – L<sub>i</sub> Total L<sub>i</sub> of all external sensors and equipment connected to the rModule.

\*4 – C<sub>o</sub> 1uF, unless the conditions stated in 60079-11:2011, Clause 10.1.5.2 part b can be satisfied.

\*5 – L<sub>o</sub> Is calculated using the formula  $\frac{1}{2} L_o(I_o \cdot 1.5)^2 = 525 \mu J$ .

For Specific Conditions of Use, Safety Description and parameters for intrinsically safe systems applicable to other certificates, please refer to the individual certificates listed above.

### **Installation of equipment**

The installation of the product must only be carried out by competent personnel. Each installation needs to be considered with reference to the local safety regulations and authorities. Refer to the following standards for additional guidance:

- IEC/EN 60079-14
- IEC/EN 60079-25

Refer to the Certification Section of this User Manual and to the relevant certificates for any installation parameters and special conditions of safe use.

### **Commissioning / verification tests prior to first use.**

Prior to commissioning and first use, the product shall be inspected for any visible damages and integrity of the enclosure. Never use the product that has damaged housing in hazardous locations.

### **Maintenance**

The maintenance of the product must only be carried out by competent personnel. Maintenance shall be considered with reference to the local safety regulations and authorities. Refer to the following standards for additional guidance:

- IEC/EN 60079-17

It is recommended to periodically check the condition of the product.

The product shall only be serviced and repaired by Trolex Ltd or a local Trolex service agent approved by Trolex Ltd in order to maintain the explosion protection of the product.

## 3. Installation

### 3.1 Safety Precautions

It is recommended that users refer to EN / IEC 60079-29-2 for guidance on the selection, installation, use and maintenance of detectors for flammable gases and oxygen, when installed in hazardous areas.

#### **Hazardous areas**

Do not disassemble the sensor whilst in the hazardous area or use a sensor that has a damaged housing in the hazardous area. Irrespective of the gas being monitored, the equipment must not be installed where there is possibility of an oxygen enriched atmosphere.

#### **Evacuation**

If a dangerous level of gas concentration is detected by the instrument, leave the area immediately.

#### **Operating Life of Gas Sensors**

Electrochemical cells contain an electrolyte that is gradually consumed during use. The average life is about two years, dependant upon the duty cycle. The response should be checked at regular intervals.

#### **Sensitivity**

Electrochemical cells for toxic gases can be affected by other interfering gases which may displace the subject gas being monitored. Steam laden atmospheres and condensation can also reduce the sensitivity.

#### **Flammable**

Be aware that some toxic gases are also 'flammable' at high percentage concentrations.

#### **Operating Limits of Catalytic Combustion Sensors**

Catalytic combustion sensors positively detect the presence of flammable gas. They rely upon the presence of oxygen in the atmosphere and should only be used for gas concentration up to the Lower Explosive Limit (LEL).

After this point, the output becomes non-linear and may erroneously indicate that the gas concentration is below the LEL. They should not be used in oxygen enriched or deficient atmospheres.

## Discrimination

Catalytic combustion sensors can detect a wide range of flammable gases but they cannot discriminate between individual gases. They will respond to most, or all, of the flammable components present in the atmosphere without distinguishing between them.

The table below shows the response variation of the catalytic combustion sensor on exposure to a range of gases and vapours at the same %LEL concentration.

The figures are experimentally derived and expressed relative to the methane signal (=100).

Gas/Vapour	Relative sensitivity	Gas/Vapour	Relative sensitivity
Methane	100	Carbon Monoxide	130
Propane	70	Hydrogen	120
n-Butane	70	Ammonia	155
n-Pentane	60	Cyclohexane	55
n-Hexane	60	Ethylene	90
Acetylene	85		

Infrared sensors are highly specific to the defined gas type and may not respond to other similar gases.

## Contamination

The response of catalytic combustion gas sensors can be affected by air borne contaminants which will reduce the sensitivity. Substances such as silicones, tetraethyl lead, sulphur compounds and phosphate esters can cause permanent degradation (poisoning). Halogenated hydrocarbons may also cause temporary inhibition.

## Interference

If the atmosphere to be monitored contains a gas that dilutes or displaces the air, this may reduce the response of catalytic sensors. Similarly, steam laden atmospheres and condensation can reduce the stability.

## High Concentrations of Flammable Gas

Exposure of low concentration catalytic combustion sensors to concentrations of flammable gas greater than the LEL can affect the sensitivity and zero stability of catalytic elements and the calibration should be checked after such an exposure.

## Toxicity

Be aware that most flammable gases and vapours are also toxic at low concentrations of LEL.



## 3.2. Tools and Test Equipment Required

No special tools are needed.

## 3.3. Siting Recommendations

### **Location of Gas Detectors**

Each installation needs to be considered in its own right, with reference to safety authorities and in compliance with mandatory local safety regulations. The sensor must be operated in accordance with the User Manual to maintain safety, reliability and to preserve safety integrity where applicable.

It is important that sensors are located in positions determined in consultation with those who have specialised knowledge of the plant or installation and of the principles of gas dispersion. Reference should also be made to those responsible for the engineering layout and topology of the plant as they will be most familiar with the nature of the potential dangers and the most likely sources of gas release.

It is also important to recognise that the characteristics of the gas source can be influenced by many factors; including the relative density or buoyancy of the gas, the pressure at the point of release, the ambient temperature and the ventilation of the site.

Sensor coverage cannot be simply expressed in terms of ‘number per unit area’.

Sensors need to be sited where they are capable of monitoring those parts of a plant where gas may accumulate or where a source of gas release is expected to occur. This way, the earliest possible warning of a gas release can be given to initiate shutdown functions, alarm functions or safe evacuation of the premises.

### **Sensor Management**

A very important part of an efficient gas monitoring system is the training of plant personnel in operation and maintenance of the sensors and the complete monitoring system. Training can be provided by qualified Trolex application engineers.

Once a sensor installation is complete, the sensor locations and types should be formally recorded and a planned test and maintenance procedure instituted.

### **STEL and TWA**

Specific gas sensors are equipped to automatically set STEL and TWA limits in accordance with EH40 standards. Only gases with a listed EH40 STEL or TWA value have this function enabled by default.

If the function is enabled for use, ensure that all accumulated data is reset to zero before the commencement of a working period.

## 3.4 Connections

### 3.4.1 0.4 to 2 V / 2 to 10 V Analogue Output Signal

A low impedance two-wire voltage output signal requiring a separate power supply to the sensor.

12 V dc power can usually be derived from the monitoring instrument being used.

The connection configuration works well up to 5-100 m distance between the sensor and the monitoring equipment, dependent on cabling and sensor current consumption.

Both the signal and the power supply to the sensor are being carried in the common 0 V conductor so at some point – influenced by the length of the cable and the resistance of the cable cores – the current flowing in the 0 V conductor will impose an unacceptable voltage error onto the signal.

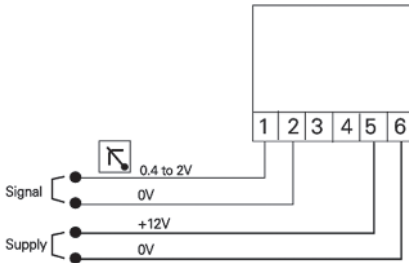

This effect can be reduced on long distance connections by increasing the size of the cable cores, or even better, by running a separate 0 V conductor to power the sensor enabling operating distances up to 1,000 m.

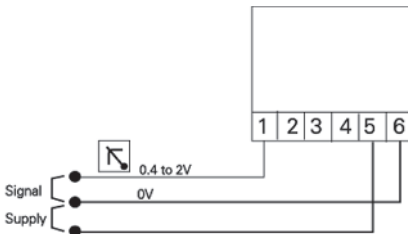

Alternatively, the sensor may be powered by a suitable power source close by.

### 3.4.2 4 to 20 mA Analogue Output Signal

#### TX6351

The output signal from terminals 1 and 2 is a conventional 4 to 20 mA two wire current regulated signal loop.

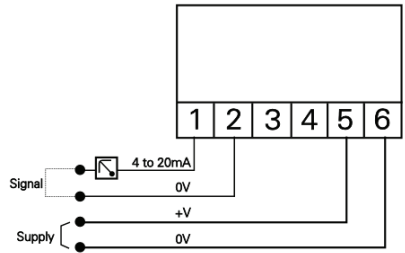

#### TX6352 (Toxic Sentro eModules only)

The output signal from terminals 1 and 2 is a conventional 4 to 20 mA two wire current regulated signal loop.

Electrochemical cells have very low power consumption so the same loop can be used to also power the sensor. No separate power supply is needed.

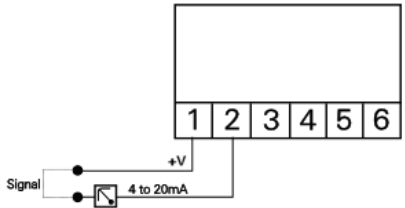

#### Checkpoint

The TX6352 version of Sentro is **NOT** suitable for flammable gas and infrared Sentro eModules.

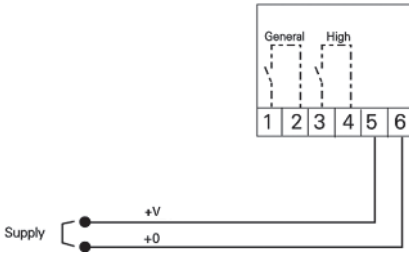

### 3.4.4 Contact Output Signal

Dual independent output contacts for remote signalling and control. Setpoint values for GENERAL alarm and HIGH alarm are setup during manufacture to prescribed levels appropriate to the type of gas intended to be monitored; determined by the gas sensing module.

The setpoints may be adjusted to preference.

#### Section 4.4.3 >>

#### Checkpoint

The relay contacts are clearance compatible for use with other intrinsically safe circuits emanating from different IS power sources.

Available with Normally Open or Normally Closed contacts.

TX6351.03.14 Normally Open (NO)

TX6351.01i.14 Normally Open (NO)

TX6351.03.17 Normally Closed (NC)

TX6351.01i.17 Normally Closed (NC)

### 3.4.5 RS485 Data Output Signal

RS485 serial data output with analogue signal intelligence.

Use in conjunction with a PC for data display and setpoint alarm warnings.

Up to 32 sensors acting as slaves can communicate with the master unit on a single data cable.

The address code of the sensor is marked on the duty label of the sensor.

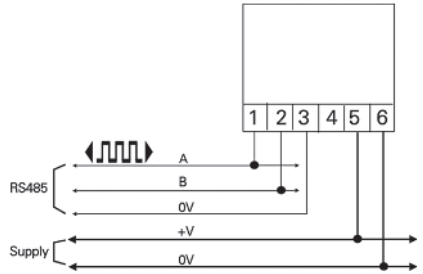

<b>Physical layer:</b>	RS485
<b>Protocol:</b>	Trox proprietary
<b>Connection mode:</b>	Modbus
<b>Number of points:</b>	32
<b>Maximum distance:</b>	1,000 m

Recommended cable (specified in BS5308 Part 1) for locally powered sensors:

- 1 twisted pair
- 0.5 mm<sup>2</sup>
- Overall screen

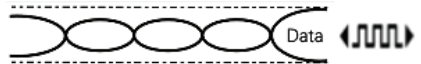

Recommended cable for sensors that are powered through the data cable:

- 2 twisted pair
- 0.5 mm<sup>2</sup>
- Individual/overall screen

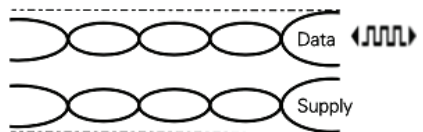

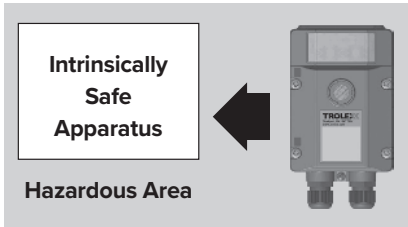

### 3.5 Connecting in Hazardous Areas

Certified Intrinsically Safe for use in mining hazardous areas, category M1, when used with approved monitoring apparatus.

Power for the sensor must be derived from an approved 12 V dc power supply e.g. TX6642 Intrinsically Safe Power Supply or approved apparatus.

The installation must be in accordance with the Sentro certification parameters.

## 4. Setup and Calibration

### 4.1 Controls and Indicators

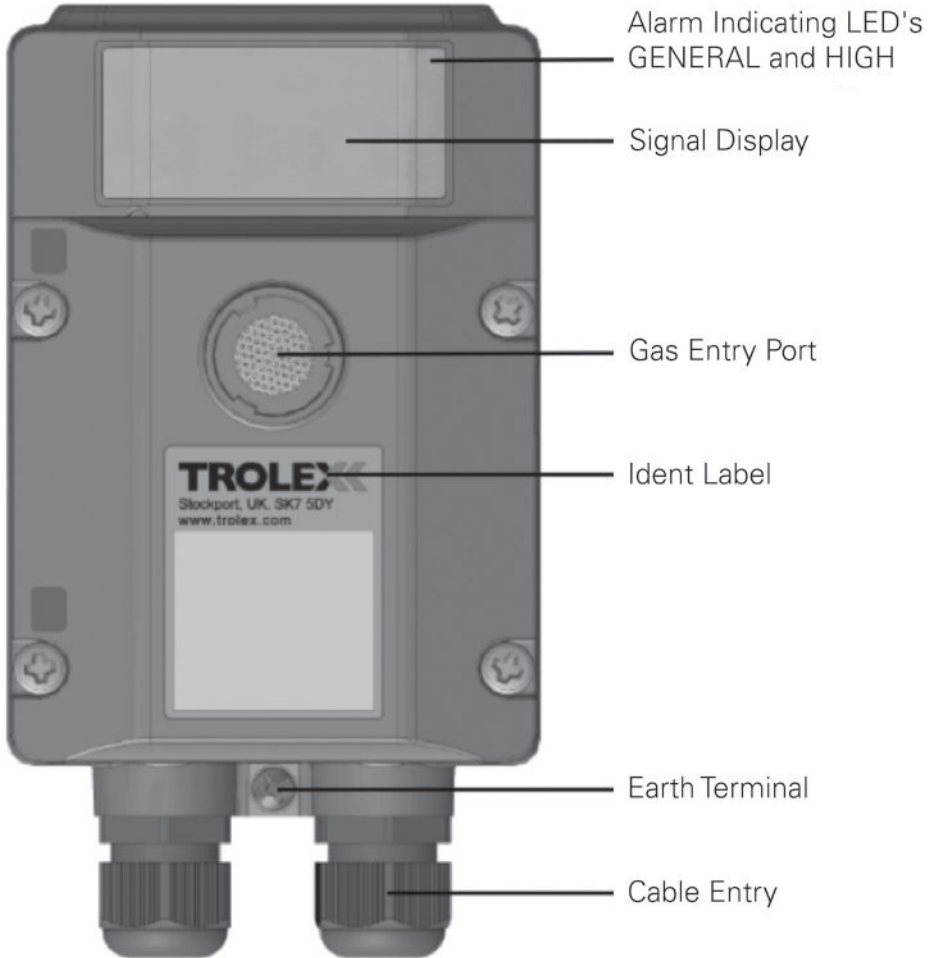

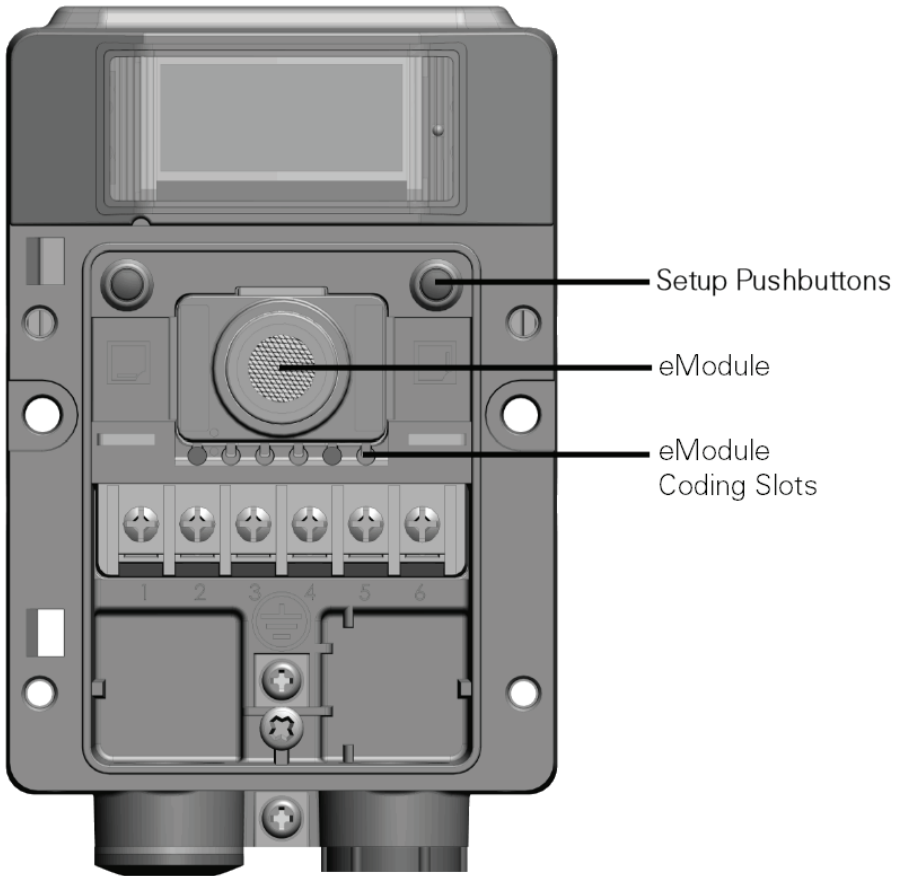



4.2 Main Display

Power On

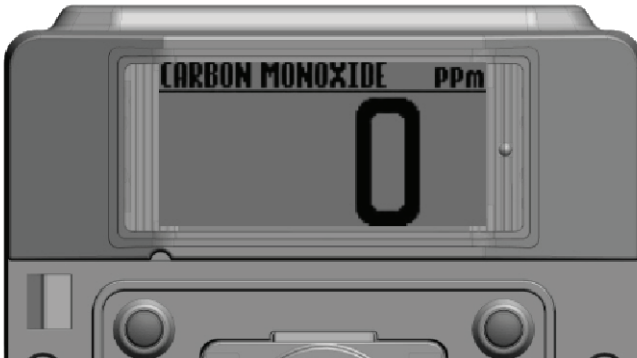
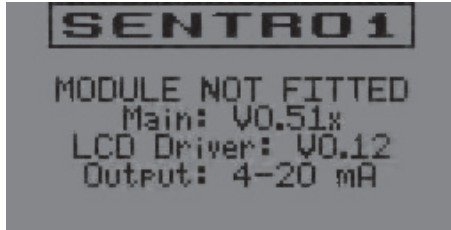

NEXT/FUNCTION

SELECT/CHANGE

**Checkpoint**

Next/Function is the **Left** hand key (**L**) and Select/Change is the **Right** hand key (**R**).

## Main Menu

Press the **R** key to enter the Main Menu

Section 4.3



Section 4.4



### Checkpoint

The front cover of Sentro may be safely removed, for setup in a hazardous area, even with the power applied.



### 4.3 Security Code Access

A security code may be requested:

Press the **R** key to change the digit

Use the **L** key to increment the digits



Use the **R** key to select Enter and return to the Main Menu

Section 4.4



4.4 Main Menu



**Checkpoint**  
 Sentro will automatically return to the Main Display if no commands are given within 1 minute. The time limit is extended to 8 minutes during calibration to allow the gas value to stabilise.

Calibrate

Section 4.4.1 >>

- Zero
- Set Test Gas
- Span

Sentro 1 Setup

Section 4.4.2 >>

- System Information
- Display Setup
- Alert Setup
- Set Security Code
- Exit

Output Setup

Section 4.4.3 >>

- Output Information
- Trim Output Zero
- Trim Output Span
- Reset Output
- Set Relay 1 Mode
- Set Relay 2 Mode
- Exit

Modbus Setup

Section 4.4.4 >>

- Modbus Address
- Baud Rate
- TX On Delay
- TX Off Delay
- Exit

Module Setup

Section 4.4.5 >>

- Setpoint 1
- Setpoint 2
- STEL/TWA
- Exit

## 4.4.1 Calibrate

Connect a Gas Test Kit equipped with both 'clean air' and the appropriate test gas canisters.

Section 5.2



### Calibrate Zero

- Follow the prompt bar and screen instructions

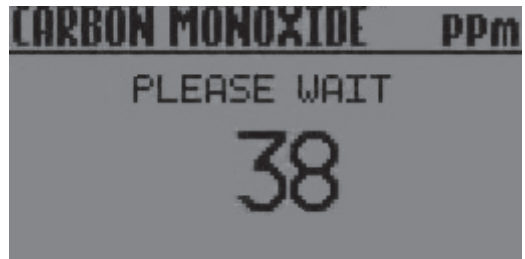
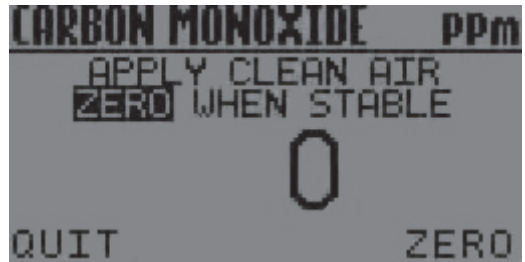

- Go to Span

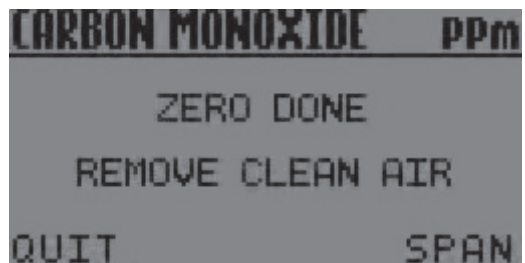

Calibrate Span using a Test Gas of EXPECTED value



- Follow the prompt bar and screen instructions



- Key Done and return to the Main Display



Press **L** and **R** together to quit and return to the main display.

## Calibrate Span using a Test Gas of DIFFERENT value

The display will show the concentration of Span Gas that is EXPECTED to be used.

Set the expected value to agree with the actual Test Gas value:

- Follow the prompt bar and screen instructions



Press **R** to continue with the normal span calibration (previous page)



4.4.2 Sentro 1 Setup

The basic functional characteristics of the sensor can be setup, or reviewed, from a choice of parameters.

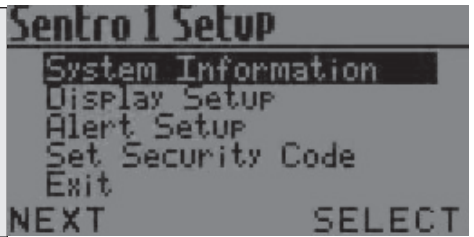

System Information Display

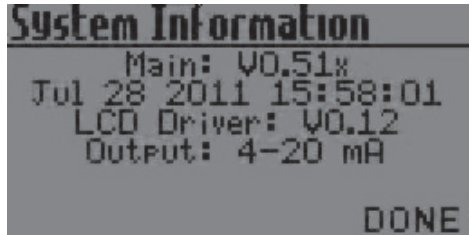

Display Setup

- The display backlight illumination may be set to on, or off, to reduce power consumption. (TX6351 only)
- The contrast of the display may be set for best visual appearance.

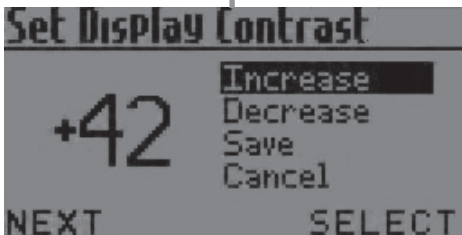

### Alert Setup (TX6351 only)

- The integral GENERAL and HIGH visual alarms can be set to ON or OFF.
- The 'confidence' condition flash can be set to ON or OFF.

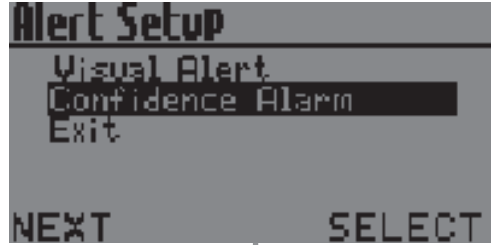

---

### Set Security Code

- A four digit security code can be entered to prevent unauthorised access to the setup menu.



0000 = Security protection OFF



### 4.4.3 Output Setup

The output signal format can be reviewed and setup to preferred values.

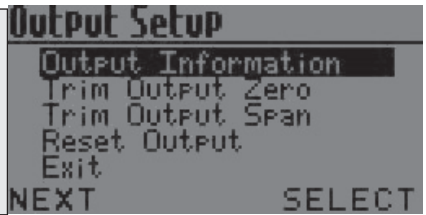

#### Output Information

- This is the factory setting of the output signal
- Confirm acceptance.

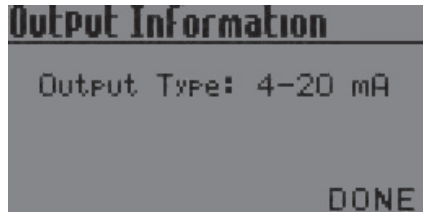

#### Trim Output Zero

- The level of the transmitted output signal, when the sensor is measuring Zero gas concentration can be trimmed or offset.

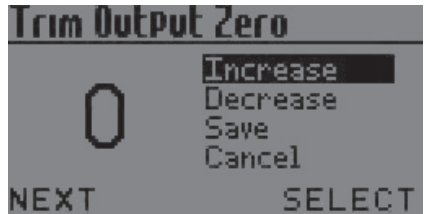

#### Trim Output Span

- The level of the transmitted output signal when the sensor is measuring given Span can be trimmed or offset.

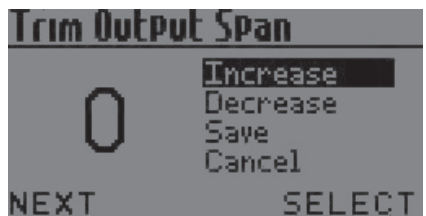

#### Reset Output

- Reset the Zero and Span output signal levels to the original default settings.

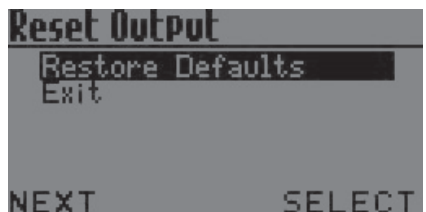

**Relay 1 Function Mode**  
**Relay 2 Function Mode**

- This item will appear in the menu on the **Contact Output** version only.
- The operating function of each relay can be independently setup.

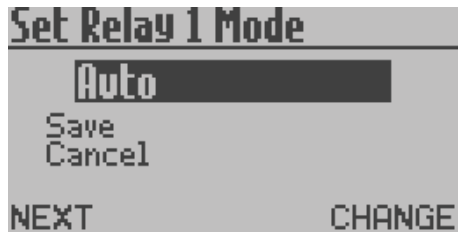
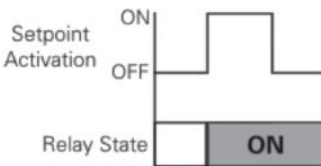
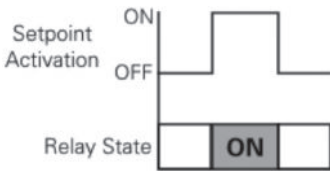
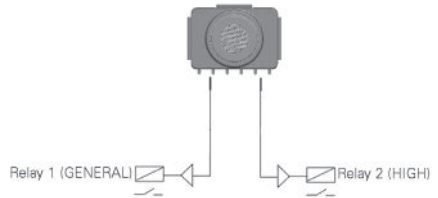

**Checkpoint**

The general relay function will be reversed when monitoring oxygen deficiency (i.e. the relay will de-energise when the measured gas concentration recedes from the setpoint value).

**To Reset a Latched Relay**

Press **L** to view Relay Status

```

Relay States
-----
Relay 1:
Mode:Latch State:OFF
Relay 2:
Mode:Auto State:ON
                                           DONE
    
```

```

Unlatch Relays
-----
Unlatch Relay 1
Unlatch Relay 2
Go to Main Menu
Exit
NEXT                               SELECT
    
```

**Checkpoint**

A Relay will stay LATCHED if the initiating signal has not receded.

```

Unlatch Relay
-----
Relay 1
Relay is still Latched.
                                           DONE
    
```

## 4.4.4 Modbus

### RS485 Output

- The protocol characteristics required for the Modbus datacomms version can be setup. Sentro can then be integrated into a wider communication network or to interface with a PC or SCADA system.

Data Protocol	Modbus
Addresses	1 to 255
Format	Binary
Databits	8
Stopbits	1
Parity	None
Baud Rate	300/600/1200/2400/4800/9600/ 14400/19200/28800/38400/57600/115200
TX On	0 to 99 ms
TX Off	0 to 99 ms
Duplex	Half

## 4.4.5 Module Setup

The functional characteristics of the Sentro eModule may be setup to preference.

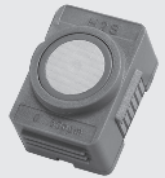

### Change Setpoint 1

### Change Setpoint 2

- The Sentro Module provides two adjustable setpoint output signals
- When setpoint 1 (General) is activated, the LED alarm indicators in the display window flash simultaneously at a rate of about once every two seconds. When setpoint 2 (high) is activated, they flash simultaneously at a rate of about 2 per second.

- The Activation mode and operating level of the setpoints can be setup to preference.

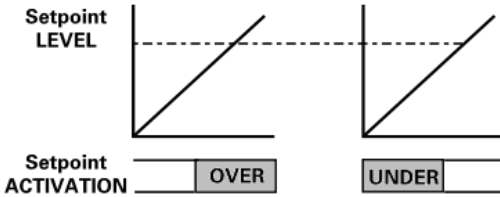

**Checkpoint**

- The setpoint output signal data will also be available for transmission on the RS485 Modbus version of Sentro.

**Checkpoint**

- The Contact Output version of Sentro 1 is also equipped with two relays

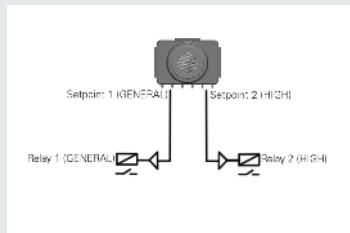

- The Activation will operate in the same way
- The Relay Function mode can also be setup

**Section 4.4.3** >>>

## STEL and TWA

- Toxic gas sensing Sentro eModules are equipped to automatically calculate STEL and TWA limits in accordance with international EH40 recommendations
- The Alert can be set to ON or OFF
- The accumulated STEL and TWA data can be reset to zero ready for the start of a new working period.

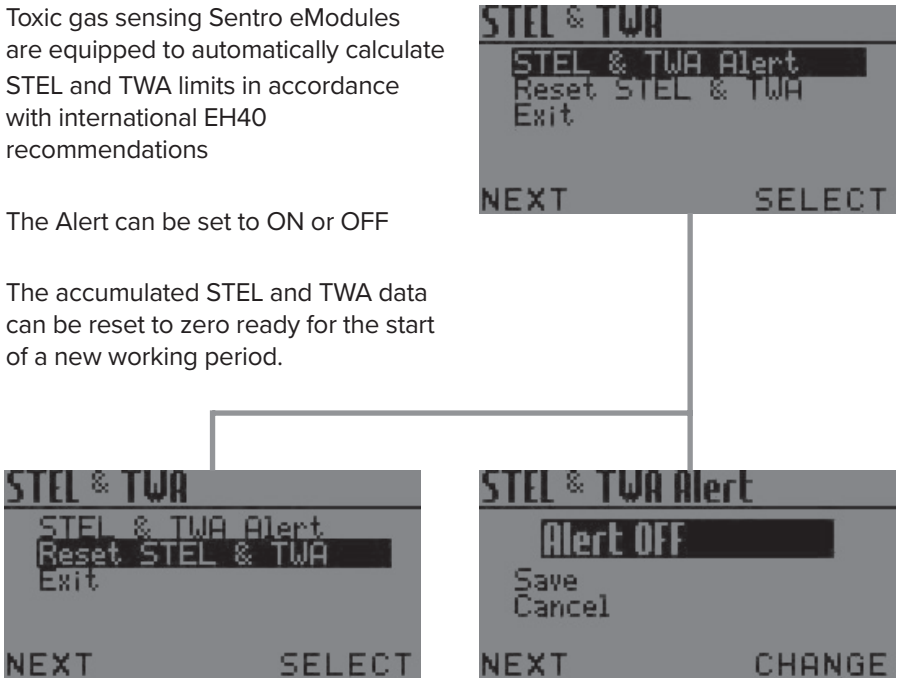

### Checkpoint

- STEL OVER or TWA OVER will be displayed when limits are exceeded.
- If the visual alarm has been enabled then this will also activate at level 1 when a STEL or TWA limit is exceeded.
- For a contact output version, the STEL and TWA alert will also initiate the Activate command for Relay 1.



### 4.4.6 Support

If you need technical support to operate this product, or would like details of our after sales technical support packages, contact **service@trolex.com**.

## 5. Diagnostics and Maintenance

### 5.1 Diagnostic Messages

#### Sensor over-range



#### Loss of signal from the sensor

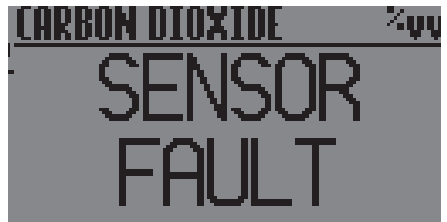

#### Pellistor Over

- The gas sensing concentration exceeds 100% LEL which is the safe working limit of the sensing element.
- The transmitted output signal from the sensor will be clamped at full scale to prevent ambiguous output data from being transmitted and will latch in this condition
- The pellistor in the gas sensing module will be switched into a PROTECT state to prevent oxidisation damage and will latch in this state.
- Check that the gas concentration has receded, then reset the module by removing it for 2 seconds.





**Module Not Fitted**

- The eModule has been removed and is out for more than 10 seconds

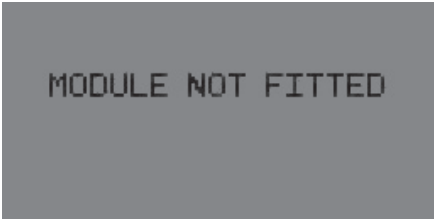

**Checkpoint**

- Under-range output signal will be transmitted by the sensor.

**5.2 Maintenance**

**Output Signal**

- Check the accuracy of the sensor at pre-determined intervals by injecting a test gas

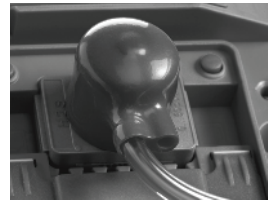

**Gas Sensing Modules**

- The Sentro eModules should be changed at regular intervals to ensure the accuracy of response
- Service history is logged within the module and this data is used to periodically assess its condition whenever it is returned for servicing. Simply insert the new module into the instrument and return the original for checking and calibration.



## Gas Inlet Port

- Check the condition and clean with a small brush to remove dust and debris



### Checkpoint

If the gas inlet port has been exposed to water conditions that exceed the IPx4 rating, dry the sensor and check its response.

Ingress protection (IP) rating does not imply that the equipment will always detect

## Annual Safety Check

The main sensor unit will not normally require maintenance or calibration, but it is advisable to return it to the Trolex Product Support Department for an annual safety check.

## Calibration

The Sentro 1 performs an important safety function and periodic calibration is an essential part of maintaining safety integrity.

Gas sensors have a known ZERO and SPAN movement related to time, level of exposure to gas, and the nature of the environment, so Trolex recommend that the sensors should be bump tested with a suitable test gas at regular intervals. This should be carried out in accordance with best practice for the industry where the gas sensor is being used.

## Trolex Calibration Recommendation Statement

- Methane and Hydrocarbon gas sensors often perform an important safety function and periodic calibration is an essential part of maintaining safety integrity.
- Pellistor gas sensors have a known ZERO and SPAN movement related to time, level of exposure to gas, and the nature of the environment.
- Trolex recommend that these sensors are 'Bump Tested' with a suitable test gas at regular intervals. This should be carried out in compliance with local requirements, or once per month will normally be adequate Calibrate the sensor if necessary, or as a minimum every 6 months, to ensure correct operation
- All other gas sensor types should also be bump tested with a suitable test gas at an interval in line with the site I industry health and safety standards and calibrated as necessary, or as a minimum every 6 months, to ensure correct operation.

**Recommended Test Gas Concentration**

Gas Sensor Type	Zero Gas	Calibration Gas/ balance gas
CH <sub>4</sub> (Pellistor) 100% LEL	Zero Air	2.2% v/v CH <sub>4</sub> in air
CH <sub>4</sub> (Infra Red)	Zero Air or Nitrogen 100%	50% to 100% of range CH <sub>4</sub> in N <sub>2</sub>
CO	Zero Air	50% to 100% of range CO in air
H <sub>2</sub> S	Zero Air	50% to 100% of range H <sub>2</sub> S in air
NO	Zero Air	50% to 100% of range NO in air
NO <sub>2</sub>	Zero Air	50% to 100% of range NO <sub>2</sub> in air
SO <sub>2</sub>	Zero Air	50% to 100% of range SO <sub>2</sub> in air
CO <sub>2</sub>	Nitrogen 100%	50% to 100% of range CO <sub>2</sub> in air
O <sub>2</sub>	Nitrogen 100%	Clean air, or 50% to 100% of range O <sub>2</sub> in N <sub>2</sub>

Standard test gas canisters are available from our Product Support department and can be supplied in a range of capacities from 34 litres up to 110 litres.

Please call our sales engineers for advice regarding recommended test gas procedures and product support plans.

Test gas equipment may be ordered from Trolex using the order code: P5393.23. The kit is comprised of a 0.5 litre/min gas regulator, pipe-work and gassing hoods.

**Checkpoint**

- CH<sub>4</sub> test gas must be combined with balance air if being used to calibrate pellistor based devices.
- 25% O<sub>2</sub> cannot be supplied. A maximum concentration of 23% can be supplied.

### 5.3 Maintenance and Calibration Log

Order Reference: TX	
Serial Number:	Date Purchased:
Gas Type:	Location:

Date	Scheduled Check	Fault	Recalibrate	Change Modules	Return to Trolex	Comments

## 5.4 Disposal

Part of the ethos of Trolex is sustainable design. **Sentro 1** contains materials that can be recovered, recycled and reused. At the end of its useful life ensure that the **Sentro 1** is recycled in accordance with local laws and bylaws for the geographic area where it is located. The end of its useful life is to be determined by the owner/operator of the equipment and not Trolex. Ensure that the **Sentro 1** is recycled by licenced waste contractors with the appropriate licences for handling electronic waste in the geographic area where the **Sentro 1** is located.

### Checkpoint

Consult your local Trolex service agent or the Trolex Product Support Department if you require assistance with disposal: [service@trolex.com](mailto:service@trolex.com)



## Disclaimers

The information provided in this document contains general descriptions and technical characteristics of the performance of the product. It is not intended as a substitute for and is not to be used for determining suitability or reliability of this product for specific user applications. It is the duty of any user or installer to perform the appropriate and complete risk analysis, evaluation and testing of the products with respect to the relevant specific application or use. Trolex shall not be responsible or liable for misuse of the information contained herein. If you have any suggestions for improvements or amendments, or find errors in this publication, please notify us at [marketing@trolex.com](mailto:marketing@trolex.com).

No part of this document may be reproduced in any form or by any means, electronic or mechanical, including photocopying, without express written permission of Trolex.

All pertinent state, regional, and local safety regulations must be observed when installing and using this product. For reasons of safety and to help ensure compliance with documented system data, only Trolex or its affiliates should perform repairs to components.

When devices are used for applications with technical safety requirements, the relevant instructions must be followed.

## Trademarks

© 2024 Trolex Limited.

Trolex is a registered trademark of Trolex Limited. The use of all trademarks in this document is acknowledged.

## Document History

Revision	Date	ECR
A	25 April 2017	4483
B	29 March 2019	4828
C	25 January 2023	5416
D	06 February 2023	5429
E	02 October 2024	5681

## Contact Details

Call us: +44 (0) 161 483 1435

Email us: [sales@trolex.com](mailto:sales@trolex.com)

Visit us: Trolex Ltd, Newby Road, Stockport, SK7 5DY, United Kingdom

