



TX9165

Sentro 8 Sensorstation



TROLEX«

User Manual

TX9165 Sentro 8 Sensorstation

Contents

1.	Product Overview	5	4.2.1	Base Screens	40
1.1	Operating Features	5	4.2.2	Sensor Inputs Overview	42
1.2	Application	6	4.2.3	Relay Outputs Overview	47
1.3	Product Options	7	4.2.4	Audio/Visual Alarms	
1.4	Dimensions	8		Overview	47
1.4.1	TX9165 Sentro 8 Sensorstation		4.3	Main Setup Menu	48
	- Four Gas Ports	8	4.3.1	Security	48
1.4.2	TX9165 Sentro 8 Sensorstation		4.3.2	Display	49
	- Eight Gas Ports	9	4.3.3	Time and Date	51
1.5	Technical Information	10	4.3.4	Log	52
1.6	Electrical Details	12	4.3.5	Datacomms Protocol	54
1.7	Sentro Sensing Modules	13	4.3.6	Reset Exposure	56
1.7.1	Sentro eModules	14	4.4	Sentro eModule Setup	58
1.7.2	Sentro rModules Remote		4.4.1	Sentro eModules Calibrate	59
	Sensing	19	4.4.2	Setpoint 1 and Setpoint 2	63
2.	Certification	20	4.4.3	Assign Fault	66
3.	Installing	24	4.4.4	Assign Exposure Alarm	67
3.1	Safety Precautions	24	4.4.5	Status	68
3.2	Siting Recommendations	26	4.5	Sentro rModule Setup	69
3.3	Connections	27	4.5.1	Scaling	70
3.4	Connecting in Mining and		4.5.2	Setpoint 1 and Setpoint 2	72
	Tunnelling Areas	34	4.5.3	Assign Fault	74
3.5	Sentro 8 Sensorstation		4.5.4	Status	75
	Sensing Module Positions	35	4.5.5	Calibrate PT100	76
3.6	Datacomms	36	4.5.6	Setup of an On/Off Input	
4.	Setup and Calibration	37		rModule	76
4.1	Controls and Indicators	37	4.5.7	Setup of an On/Off Diode	
4.1.1	Navigation	39		Input rModule	76
4.2	Start-up Screen	40	4.6	Output Relays Setup	78

4.6.1	Mode	78	7.5	Maintenance and Calibration Log	91
4.6.2	Pulse Time	79	7.6	Record Keeping	92
4.6.3	Assign Fault	79	7.7	Protection Grid	92
4.6.4	And Function	80	7.8	Servicing and Repair	92
4.6.5	Text	80	7.9	Disposal	93
5.	Audio/Visual Alarm		8.	Sentro 8 Battery Back-up	94
	References	81	8.1	Intruduction	94
5.1	Alarm Severity Selection	81	8.2	Battery Back-up	94
5.2	Assign Fault	82	8.3	Battery	95
6.	Diagnostics	83	8.4	RS485 Repeater	95
6.1	Over Range Indication on a Pellistor Gas Sensing eModule	83	8.5	Ethernet Converter	95
6.2	Absent Sensing Module Message	84	8.6	Battery Back-up Connections	96
6.3	Replacing a Sentro Sensing Module	84	8.7	Operation	96
6.4	Low Supply Voltage	85	8.7.1	Power-up	96
6.5	Latched Relay Message and Relay Reset	85	8.7.2	Power Down	97
7.	Maintenance	86	8.8	Maintenance	98
7.1	Sentro eModules and rModules	86	8.8.1	Sentro 8 and Battery Back-up - Check	98
7.2	Trox calibration recommendation statement	86	8.8.2	Battery Back-up Discharge - Test	98
7.3	Service Replacement Sensing Modules	88	8.8.3	Battery Back-up Cells - Replace	99
7.4	Replacing a Sentro Sensing Module	88	8.9	Repairs	99
				Disclaimers	100
				Trademarks	100
				Document History	100
				Contact Details	100

1. Product Overview



TX9165 Sentro 8 Sensorstation
(four gas ports)





TX9165 Sentro 8 Sensorstation
(eight gas ports)

1.1 Operating Features

- Integrated eight channel sensing and control unit for environmental and machine condition monitoring including
 - eModule
 - Toxic gases
 - Flammable gases
 - rModule
 - Air flow
 - Pressure
 - Temperature
 - Vibration
 - Speed
 - Rotation
 - Most suitable 0.4 to 2 V and 4 to 20 mA inputs
- Pre-calibrated plug-in Sentro eModules and rModules can be user configured to any combination of measuring parameter
- LCD screen
- Programmable built-in Audio/visual alarms
- RS485 Modbus datacomms for distributed monitoring of systems
- Four programmable output relay remote alarm warning and control functions
- Heavy duty, impact resistant housing to IP65
- EMC compliant
- STEL and TWA monitoring of selected gases
- Data logging on all channels

1.2 Application

Fixed point multisensor environmental monitoring and machine condition monitoring for use in underground mining and general purpose applications.

<p>General Purpose TX9165.03</p> 	<p>Application: Supply voltage:</p> <p>Remote sensors: Output relay contacts:</p>	<p>Non-hazardous areas 24 V dc 85 to 265 V ac supply (universal) 24 V dc supply 2 Amps, 230 V ac</p>
<p>Underground Mining and Tunnelling TX9165.01i</p> 	<p>Application: Supply voltage:</p> <p>Remote sensors: Output relay contacts:</p> <p>Type of protection: Category: ATEX:</p>	<p>Can be installed in underground hazardous areas 12 V dc from an approved source Exi approved, 12 V dc supply Suitable for, and clearance compatible for, switching other intrinsically safe circuits Intrinsically safe, EX ia M1 94/9/EC</p>

1.3 Product Options

TX9165 Sentro 8 Sensorstation	Mining Ex	General Purpose
12 V dc	TX9165.01	-
24 V dc	-	TX9165.03.102
85 to 265 V ac (universal)	-	TX9165.03.114



1.4 Dimensions

1.4.1 TX9165 Sentro 8 Sensorstation - Four Gas Ports

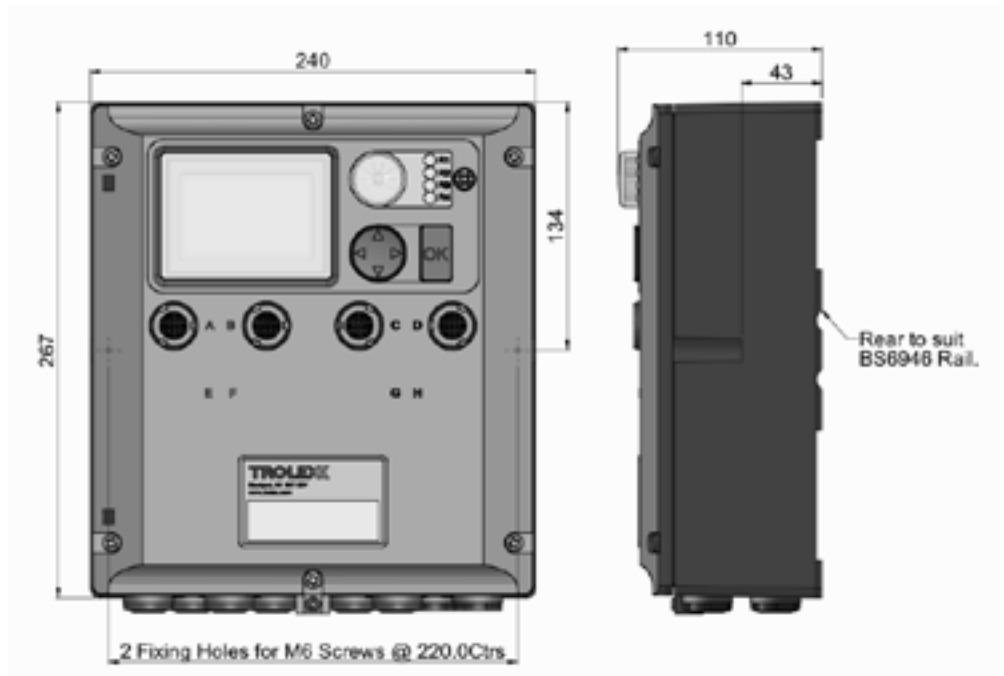

1.4.2 TX9165 Sentro 8 Sensorstation - Eight Gas Ports

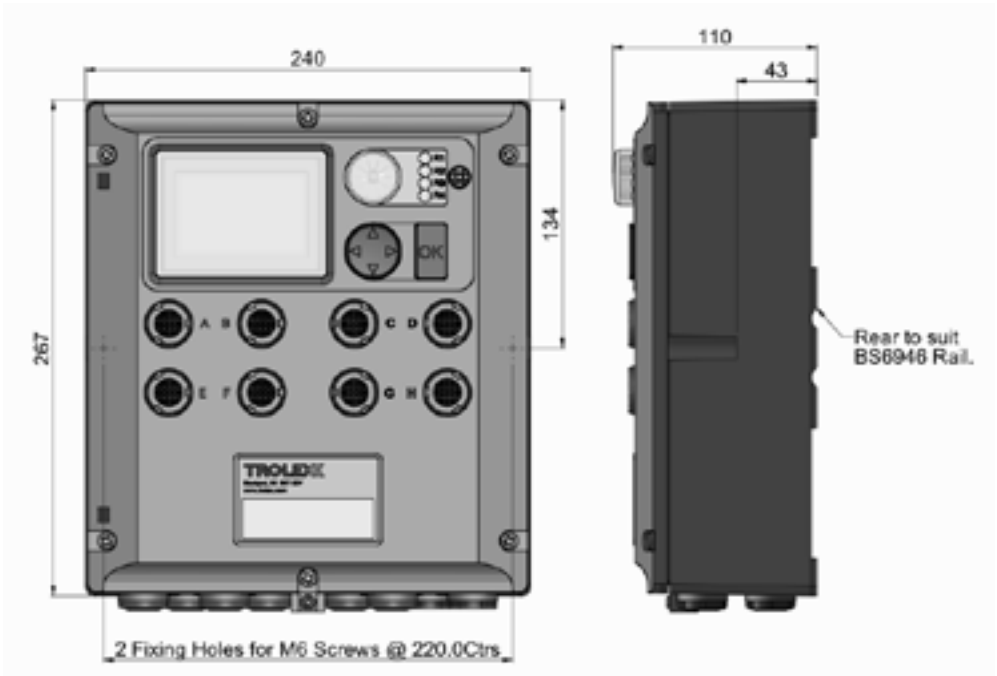

1.5 Technical Information

Sensing modules:	<ul style="list-style-type: none">• Plug-in, pre-calibrated Sentro eModules and rModules with standardised output data and characterised compensation. Accommodation for up to eight eModules and rModules
Protection classification:	<ul style="list-style-type: none">• Housing IP65
Operating temperature:	<ul style="list-style-type: none">• -10 to +40°C
Storage temperature:	<ul style="list-style-type: none">• -20 to +60°C
Humidity:	<ul style="list-style-type: none">• 0 to 95% non-condensing
Pressure:	<ul style="list-style-type: none">• 700 to 1300 mbar
Housing material:	<ul style="list-style-type: none">• Reinforced polymer, anti-static, suitable for use in hazardous areas. EMC compliant
Weight:	<ul style="list-style-type: none">• 2.8 kg
Alarm indicators:	<ul style="list-style-type: none">• Confidence Alert flash and audible tone at 15 second intervals• High-brightness, area warning, flashing alarm and audible alarm• Function configurable
Audible alarm:	<ul style="list-style-type: none">• High intensity audible sounder 95 dB at 300 mm• Function configurable• Mute function
Gas infusion:	<ul style="list-style-type: none">• Natural diffusion

Display:	<ul style="list-style-type: none">• 128 x 64 pixels, graphic LCD screen with backlight illumination• Alarm indicators for all eight sensor inputs• TWA and STEL alarm displayed for selected toxic gas sensing eModules• Simultaneous readings of all sensor input levels• Individual reading of all sensor input levels with Min and Max data retention• Graphic Trend display of individual sensor values• Scrolling display of Logged data
Function programming:	<ul style="list-style-type: none">• Screen contrast adjustment• Keycode security barrier• Two independently programmable setpoint alarm levels, selectable for Over, Under or Window alarm functions for each sensor input• Audio visual alarm functions• Discrete alarms for General/High sensor signal and Fault• 24-hour clock and calendar
Data logging:	<ul style="list-style-type: none">• Automatic period logging• 4000 readings per sensor with time, date and alarm event report
Datacomms:	<ul style="list-style-type: none">• RS485 datacomms output supporting up to 32 Sentro 8 Sensorstations on a single Modbus network in multidrop mode to a standard PC• System reporting

1.6 Electrical Details

Description	Mining Ex	General Purpose
Supply voltage	12 V dc (+/- 10%)	24 V dc (+/- 10%)/ 85 to 265 V ac
Supply current	200 mA (maximum loading including one pellistor eModule)	
Output relays	Four independent alarms relays each programmable to any alarm setpoint on any monitoring channel for preferred alarm priority grouping	
Relay contacts	One changeover contact on each relay	
Contact rating	Suitable for, and clearance compatible for, intrinsically safe circuits	2 Amps 230 V ac

1.7 Sentro Sensing Modules

Plug-in pre-calibrated eModules and rModules with standardised output data.

- Each eModule and rModule stores all the necessary data about its type, identification, sensing range and specific calibration. This data is automatically recognised by Sentro 8 Sensorstation when the eModule or rModule is plugged into the module bay
- The eModule and rModule are pre-calibrated so they can be replaced at any time with a replacement sensing module - usually of the same type, but an alternative may be inserted if required
- User configurable coding slots at each module bay can be individually configured using coding stops to prevent invalid sensing module combinations
- The eModule and rModule will identify itself when plugged into the module bay, auto configuration will take place and the sensing module type will display on the LCD screen
- All Sentro eModules and rModules have two output alarm signals for General alarm and High alarm. Default values are entered during manufacture and these can be changed to preferred values
- There are two types of Sentro sensing module:



Sentro eModule
Integral Gas Sensor



Sentro rModule
Terminals for Connecting Remote Sensors

1.7.1 Sentro eModules

For the full range of Sentro eModules refer to the Sentro 8 Product Data Sheet TX9165-DS-EN or contact the Trolex Sales Team: sales@trolex.com

1.7.1.1 Flammable Gases • Poison Resistant Catalytic Sensor

The sensor will respond to most flammable gases and vapours to varying degrees; it is normally calibrated to methane in terms of %LEL or %volume.



TX6350	.240	.246	.244
	Methane CH ₄	Methane CH ₄	Methane CH ₄
Sensing element	Poison resistant pellistor with active temperature/humidity compensation		
Sensing range	0 to 100% LEL	0 to 4% v/v	0 to 5% v/v
Linearity	Linear to 3% v/v and 3% to 5% ±0.25% v/v		
Max. Drift @ 25°C	±0.25% CH ₄ v/v per month		
Response time (T63)	< 15 secs		
Response time (T90)	< 20 secs		
Sensing element life	> 5 years in clean atmosphere		
Warm up time	< 5 mins in air or 1% v/v CH ₄ (to 95% of stated accuracy)		
GENERAL alarm	10% LEL (0.44% v/v)		
HIGH alarm	20% LEL (0.88% v/v)		

Checkpoint

The pellistor is automatically protected against exposure to excessively high concentrations of gas.

1.71.2 Toxic Gases • Electrochemical Cells

Selected toxic gas eModules are equipped with automatic STEL/TWA calculation in accordance with COSHH.



TX6350	.250.50	.250.250	.250.500	.251	.252
	Carbon Monoxide CO	Carbon Monoxide CO	Carbon Monoxide CO	Hydrogen Sulphide H ₂ S	Sulphur Dioxide SO ₂
Sensing element	Electrochemical cell				
Sensing range	0 to 50 ppm	0 to 250 ppm	0 to 500 ppm	0 to 50 ppm	0 to 20 ppm
Linearity	±2% FS				
Drift	2% per month				
Repeatability	±2%				
Response time T63%	<20 secs	<20 secs	<20 secs	<30 secs	<20 secs
Operating life	2 years				
Relative humidity	15 to 90% non-condensing				
Operating temperature	-10 to +40°C				
GENERAL alarm	15 ppm	30 ppm	30 ppm	5 ppm	5 ppm
HIGH alarm	30 ppm	100 ppm	200 ppm	10 ppm	10 ppm
STEL & TWA	200 ppm	200 ppm	200 ppm	10 ppm	5 ppm
	30 ppm	30 ppm	30 ppm	5 ppm	2 ppm

Toxic Gases • Electrochemical Cells - continued



TX6350	.254	.255	.257	.259	.261
	Nitrogen Dioxide NO ₂	Chlorine Cl ₂	Oxygen O ₂	Nitric Oxide NO	Hydrogen H ₂
Sensing element	Electrochemical Cell				
Sensing range	0 to 20 ppm	0 to 10 ppm	0 to 25%	0 to 50 ppm	0 to 1000 ppm
Linearity	±2% FS	±5% FS	±5% FS	±5% FS	±2% FS
Drift	2% per month	2% per month	10% per year	2% per month	2% per month
Repeatability	±2%				
Response time T63%	<20 secs	<20 secs	N/A	<20 secs	<70 secs
Operating life	2 years	2 years	2 years	2 years	2 years
Relative humidity	15 to 90% non-condensing				
Operating temperature	-10 to +40°C				
GENERAL alarm	5 ppm	2.5 ppm	19% (under)	5 ppm	250 ppm
HIGH alarm	10 ppm	5 ppm	23% (over)	20 ppm	500 ppm
STEL & TWA	5 ppm	N/A	N/A	10 ppm	N/A
	3 ppm	0.5	N/A	3 ppm	N/A

Checkpoint

All values listed are nominal and slight variations may occur depending upon operating conditions.

- The natural level of oxygen available in the atmosphere is influenced by relative humidity and temperature. The oxygen sensor will react to these changes.
- Sudden changes in atmospheric pressure will also cause temporary instability in electrochemical sensors which may exceed 60 seconds.
- Long periods of use in extremely high or low humidity may affect the response of the sensor and shorten the life of electrochemical sensors.
- Nitric oxide sensors (TX6351.259) must be continuously powered to maintain calibration stability. If power has been absent for more than 10 minutes, it may take 24 to 48 hours for the sensor to restore stability. Do not calibrate until the output signal is steady.
- The presence of high levels of carbon dioxide (over 5%) may have a minor effect on the accuracy of the oxygen sensor.

Checkpoint

- Methane and Hydrocarbon gas sensors often perform an important safety function and periodic calibration is an essential part of maintaining safety integrity.
- Pellistor gas sensors have a known ZERO and SPAN movement related to time, level of exposure to gas, and the nature of the environment.
- Trolex recommend that these sensors are 'Bump Tested' with a suitable test gas at regular intervals. This should be carried out in compliance with local requirements, or once per month will normally be adequate. Calibrate the sensor if necessary, or as a minimum every 6 months, to ensure correct operation.
- All other gas sensor types should also be bump tested with a suitable test gas at an interval in line with the site/industry health and safety standards and calibrated as necessary, or as a minimum every 6 months, to ensure correct operation.

1.7.1.3 Carbon Dioxide/Methane Gases • Infrared Sensor

This sensor is highly specific to the selected gas and exhibits consistent sensing accuracy with superior long-term stability.



The linear response means that it can be calibrated for low gas concentrations and high concentrations up to 100% by volume.

TX6350	.243	.245	.242	.278	.279
	Methane CH ₄	Methane CH ₄	Methane CH ₄	Carbon Dioxide CO ₂	Carbon Dioxide CO ₂
Sensing element	Infrared				
Sensing range	0 to 5% v/v	0 to 100% LEL	0 to 100% v/v	0 to 5% v/v	0 to 100% v/v
Zero drift	±0.05% v/v per month	±1% LEL per month	±0.5% v/v per month	±0.5% v/v per month	±1% v/v per month
Repeatability	±0.1% v/v	±2% LEL	±2% v/v	±0.05% v/v	±2% v/v
Response time T63%	<15 secs				
Response time T90%	<30 secs				
Operating life	<5 years				
Relative humidity	15 to 90% condensing				
Operating temperature	-10 to +40°C				
GENERAL alarm	1.25% v/v	10% LEL	25% v/v	1.25% v/v	25% v/v
HIGH alarm	2.5% v/v	20% LEL	50% v/v	2.5% v/v	50% v/v

Checkpoint



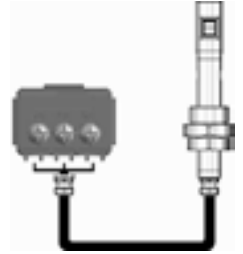

Carbon Dioxide Sensors - Normal atmosphere contains carbon dioxide which will affect the sensor signal so nitrogen gas must be used to accurately calibrate the zero value. The sensor should be powered-up and the nitrogen applied for at least 5 minutes to ensure that the sensor has stabilised.

1.7.2 Sentro rModule Remote Sensing



Sentro rModules function in the same way as eModules and incorporate screw terminals to accept direct input connections of cables from remote analogue or digital sensors. A sensor power supply source is also provided at the rModule terminals where appropriate.



All eight positions (A to H) in the Sentro 8 Sensorstation can be fitted with rModules in positions where no eModules are being used.

TX9160.301	4 to 20 mA	Industrial standard analogue sensor input; 2 and 3 wire options	
TX9160.303	0.4 to 2 V	Voltage input signals, analogue sensor input; 2 and 3 wire connections	
TX9160.306	PT100	Standard PT100 temperature monitoring with line compensation	
TX9160.501	ON/OFF	NAMUR proximity switch with line-fault monitoring or conventional contacts; pressure switches, limit switches, etc	
TX9160.502	ON/OFF & Diode	ON/OFF inputs from contacts with series diode for open circuit and short circuit line fault monitoring	

2. Certification

	<p>Europe Certification (ATEX) TX9165.01.i Sentro 8 Sensorstation (Group 1) Ex Certificate Number: SIRA 09ATEX2285X Ex Certification Code: I M1 Ex ia I Ma</p> <p>General Conditions for Safe Use – Prior to installation, it is essential that the user refers to the above certificate to ensure that the termination and cable parameters are fully complied with and are compatible with the application. Copies of certificates are available from Trolex Ltd.</p> <p>Cable glands used with this equipment must maintain an ingress protection of at least IP54.</p>
	<p>ATEX directive 94/9/EC EMC directive 2004/108/EC</p>

Special Conditions for Safe Use of Sentro eModules and rModules

The minimum ingress protection stated in the Ex-certificates for the Sentro eModules and rModules are satisfied when mounted in the Sentro 8 Sensorstation, as are the conditions for impact protection and external fuse protection in the case of the infrared eModule. The Ex-certificates associated with the Sentro eModules and rModules are listed below:

eModule - Flammable (Group I)	SIRA 10ATEX2046U
eModule - Toxic (Group I)	SIRA 08ATEX2097U
eModule - Infrared (Group I)	SIRA 10ATEX2356U
rModule - (Group I)	SIRA 10ATEX2032U

Attention is drawn to the following conditions within the rModule Ex-certificates:

For the purpose of this certificate, a P+F inductive sensor to PTB00 ATEX 2048X to Category II 1G Ex ia IIC T6 connected to terminals 1m and 2 m of a TX9160.01i.501 NAMUR input module may be considered equivalent to Category I M1. The sensor

shall be installed in such a manner as meets the requirements of Group I e.g. the external; enclosure to meet IP54, impact protection etc.

Where an external sensor is used with Type TX9160.01i.301 (4 to 20 mA), TX9160.01i.303 (0.4 to 2 V), TX9160.01i.321 (4 to 20 mA Differential) or TX9160.01i.323 (0.4 to 2 V Differential) rModules and powered from a separate intrinsically safe power supply, the following conditions shall be met:

- No connection shall be made to rModule terminal 1m (power).
- The 0 V of the external sensor power supply shall be connected to the 0 V input of the equipment that the rModule is plugged into.
- The UI presented by an externally powered sensor to any rModule, terminals 2 m or 3 m, shall not exceed 14.4 V.

	<p>International Certification (IECEX) TX9165.01.i Sentro 8 Sensorstation (Group 1) Ex Certificate number: IECEX SIR 09.0120X Ex Certification Code: Ex ia I Ma</p>
<p>General Conditions for Safe Use – Prior to installation, it is essential that the user refers to the relevant certificate to ensure that the termination and cable parameters are fully complied with and are compatible with the application. Copies of certificates are available from www.trolex.com.</p>	

Points to note relating to Sentro eModules and rModules

The minimum ingress protection stated in the Ex-certificates for the Sentro eModules and rModules are satisfied when mounted in the Sentro 8 Sensorstation, as are the conditions for impact protection and external fuse protection in the case of the infrared eModule. The Ex-certificates associated with the Sentro eModules and rModules are listed below:

eModule - Flammable (Group I)	IECEX SIR 10.0018U
eModule - Toxic (Group I)	IECEX SIR 08.0036U
eModule - Infrared (Group I)	IECEX SIR 10.0185U
rModule - (Group I)	IECEX SIR 10.0013U



Attention is drawn to the following conditions within the rModule Ex-certificates:

For the purpose of this certificate, a P+F inductive sensor to PTB00 ATEX 2048X to Category II 1G Ex ia IIC T6 connected to terminals 1 m and 2 m of a TX9160.01i.501 NAMUR input module may be considered equivalent to Category I M1. The sensor shall be installed in such a manner as meets the requirements of Group I e.g. the external; enclosure to meet IP54, impact protection etc.

Where an external sensor is used with Type TX9160.01i.301 (4 to 20 mA), TX9160.01i.303 (0.4 to 2 V), TX9160.01i.321 (4 to 20 mA Differential) or TX9160.01i.323 (0.4 to 2 V Differential) rModules and powered from a separate intrinsically safe power supply, the following conditions shall be met:

- No connection shall be made to rModule terminal 1 m (power).
- The 0 V of the external sensor power supply shall be connected to the 0 V input of the equipment that the rModule is plugged into.
- The UI presented by an externally powered sensor to any rModule, terminals 2 m or 3 m, shall not exceed the 14.4 V.

	<p>Russia Certification (Customs Union) TX9165.01.i Sentro 8 Sensorstation (Group 1) Ex Certificate Number: RU C-GB.ГБ05.B.00616 Ex Certificate Code: PO Ex ia I Ma X</p> <p>General Conditions for Safe Use – Prior to installation, it is essential that user refers to the above certificate for any special conditions for safe use. The user must ensure that the termination and cable parameters are fully complied with and are compatible with the application. Copies of certificates are available from Trolex.</p>
	<p>South Africa Certification TX9165.01.i Sentro 8 Sensorstation (Group 1) Ex Certificate Number: MASC M/11-420</p> <p>General Conditions for Safe Use – Prior to installation, it is essential that user refers to the above certificate to ensure that the termination and cable parameters are fully complied with and are compatible with the application. Copies of certificates are available from Trolex.</p>

	<p>Australia Certification (IECEX) TX9165.01.i Sentro 8 Sensor Station Ex Certificate number: IECEX ITA 13.0023X Issue 0 Ex Certification code: Ex ia I Ma</p> <p>Conditions of Safe Use – Where an external sensor is used with Type TX9160.01i.301 (4 to 20 mA), TX9160.01i.303 (0.4 to 2 V), TX9160.01i.321 (4 to 20 mA Differential) or TX9160.01i.323 (0.4 to 2 V Differential) rModules and powered from a separate intrinsically safe power supply, the following conditions shall be met:</p> <ul style="list-style-type: none"> • No connection shall be made to rModule terminal 1m (power) • The 0 V of the external sensor power supply shall be connected to the 0 V input of the equipment that the rModule is plugged into • The Ui presented by the external sensor on the rModule terminals 2 m and 3 m shall not exceed 14.4 V <p>General Conditions for Safe Use – Prior to installation, it is essential that user refers to the above certificate to ensure that the termination and cable parameters are fully complied with and are compatible with the application. Copies of certificates are available from Trolex Ltd.</p> <p>Cable glands used with this equipment shall maintain an ingress protection of at least IP54.</p>
	<p>India Test Report TX9165.01.i Sentro 8 Sensor Station Test Report number: CIMFR/TC/P/H555</p>

3. Installing

3.1 Safety Precautions

Hazardous Areas

Do not disassemble the Sentro 8 Sensorstation whilst in the hazardous area or use a sensor that has a damaged housing in the hazardous area.

Evacuation

If a dangerous level of gas concentration is detected by a sensor, leave the area immediately.

Operating Life of Gas Sensors

Electrochemical cells contain an electrolyte that is gradually consumed during use. The average life is about two years, dependant upon the duty cycle. The response should be checked at regular intervals. Refer to Chapter 7 - Maintenance for further information.

Sensitivity

Electrochemical cells for toxic gases can be affected by other interfering gases which may displace the subject gas being monitored. Steam laden atmospheres and condensation can also reduce the sensitivity.

Flammable

Be aware that some toxic gases are also 'flammable' at high percentage concentrations.

Operating Limits of Catalytic Combustion Sensors

Catalytic combustion gas sensors positively detect the presence of flammable gas. They rely upon the presence of oxygen in the atmosphere and should only be used for gas concentrations up to the Lower Explosive Limit (LEL).

After this point, the output becomes non-linear and may erroneously indicate that the gas concentration is below the LEL. They should not be used in oxygen enriched or deficient atmospheres.

Discrimination

Catalytic combustion sensors can detect a wide range of flammable gases but they cannot discriminate between individual gases. They will respond to most, or all, of the flammable components present in the atmosphere without distinguishing between them.

Infrared sensors are highly specific to the defined gas type and may NOT respond to other similar gases.

Contamination

The response of catalytic combustion gas sensors can be affected by air borne contaminants which will reduce the sensitivity. Substances such as silicones, tetraethyl lead, sulphur compounds and phosphate esters can cause permanent degradation (poisoning). Hydrocarbons may also cause temporary inhibition.

Interference

If the atmosphere to be monitored contains a gas that dilutes or displaces the air, this may reduce the response of catalytic sensors. Similarly, steam laden atmospheres and condensation can reduce the stability.

High Concentrations of Flammable Gas

Exposure of low concentration catalytic combustion sensors to concentrations of flammable gas greater than the LEL can affect the sensitivity and zero stability of catalytic elements and the calibration should be checked after such an exposure.

Toxicity

Be aware that most flammable gases and vapours are also toxic at low concentrations of LEL.

3.2 Siting Recommendations

Location of Gas Detectors

Each installation needs to be considered in its own right, with reference to safety authorities and in compliance with mandatory local safety regulations. The sensor must be operated in accordance with the User Manual to maintain safety, reliability and to preserve safety integrity where applicable.

It is important that sensors are located in positions determined in consultation with those who have specialised knowledge of the plant or installation and of the principles of gas dispersion. Reference should also be made to those responsible for the engineering layout and topology of the plant as they will be most familiar with the nature of the potential dangers and the most likely sources of gas release.

It is also important to recognise that the characteristics of the gas source can be influenced by many factors; including the relative density or buoyancy of the gas, the pressure at the point of release, the ambient temperature and the ventilation of the site.

Sensor coverage cannot be simply expressed in terms of 'number per unit area'. Sensors need to be sited where they are capable of monitoring those parts of a plant where gas may accumulate or where a source of gas release is expected to occur. This way the earliest possible warning of a gas release can be given to initiate shutdown functions, alarm functions or safe evacuation of the premises.

Sensor Management

A very important part of an efficient gas monitoring system is the training of plant personnel in operation and maintenance of the sensors and the complete monitoring system. Training can be provided by qualified Trolex application engineers.

Once a sensor installation is complete, the sensor locations and types should be formally recorded and a planned test and maintenance procedure instituted.

STEL and TWA

Selected gas sensors are equipped to automatically calculate STEL and TWA limits in accordance with COSHH standards. If the facility is selected for use, ensure that all accumulated data is reset to zero before the commencement of a working period.

Section 4.2.2.5 >>>

Section 4.3.6 >>>

Section 4.4.4 >>>

3.3 Connections

TX9165.03 (General Purpose)

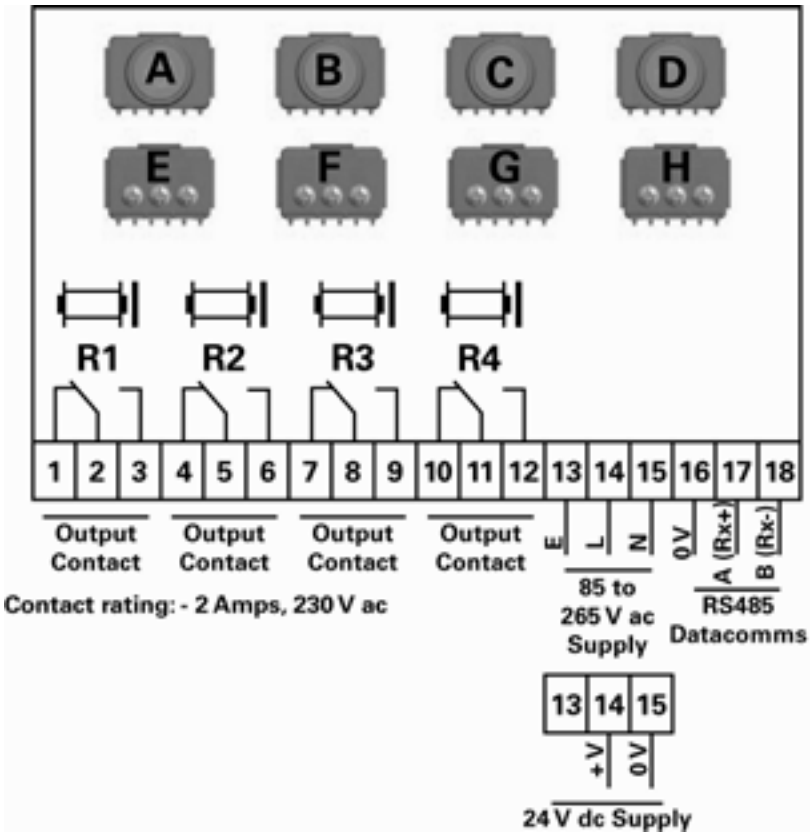

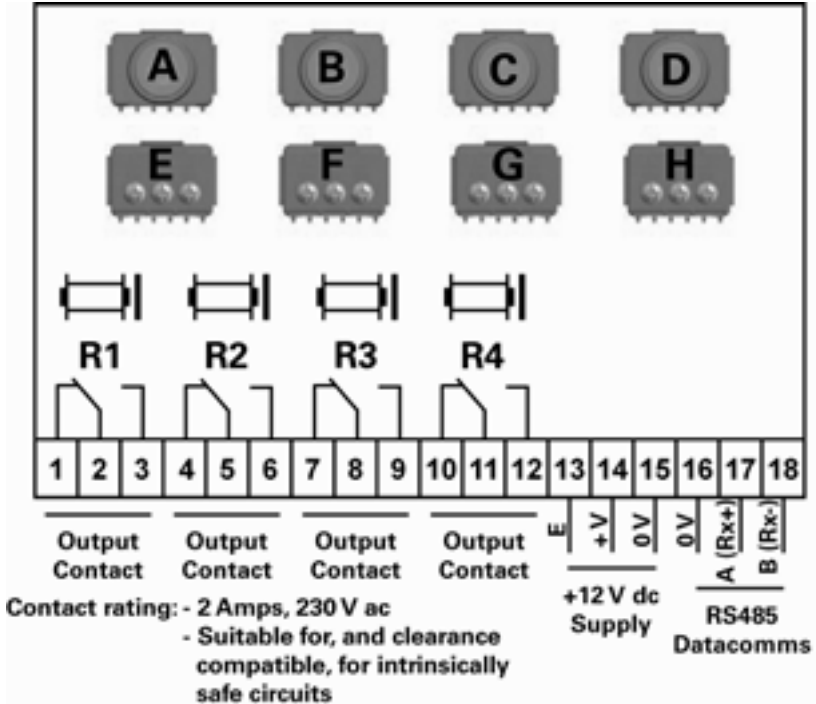

Relay Output Contacts



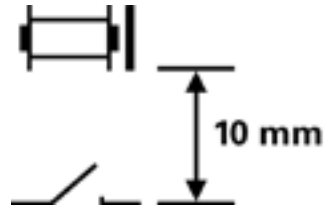





















Each relay output R1, R2, R3 and R4 has galvanic isolation between coil and contacts to intrinsically safe standards, so different external intrinsically safe control circuits may be connected to the Sentro 8 Sensorstation.



Datascomms Ports

Datascomms signals must be approved intrinsically safe. The power supply for the datascomms signal may come from a different intrinsically safe source.

Relay Operation (R1, R2, R3 and R4)

	Setpoint Setup in OVER condition 	Setpoint Setup in UNDER condition 
Power OFF 	LED  	LED  
Power ON 	 	 
Set point  	 	  Setpoint activated OFF
Set point  	  Setpoint activated ON	 

Section 4.4.2 

Connections to Sentro rModules

Remote sensor input cables are connected directly into a Sentro rModule that may be loaded into module bays, E to H.

- The rModules are creepage and clearance compliant with intrinsically safe requirements.
- Most remote sensors can normally be powered by the supply source available from the Sentro rModule.

4 to 20 mA Analogue Sensing Module

TX9160.301

rModule

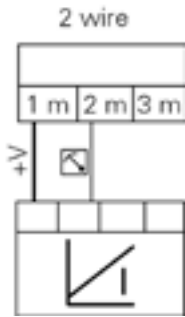

- 2 wire signal loop
- Line powered sensor



- 2 wire signal loop
- Additional wire for sensor power 0 V

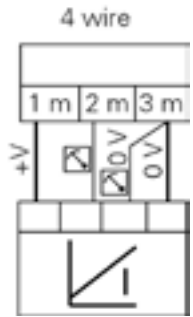

- 2 wire signal loop
- 2 wires for power + V and 0 V

Max. cable length

1.5 mm²

2.5 mm²

2000 m

5000 m

Max. external loop resistance

600 ohms

Sensor voltage

TX9165.01

Use 12 V dc sensor

12 V dc via module

12 V dc via module

TX9165.03

Use 24 V dc sensor

24 V dc via module

24 V dc via module

Sensor current available

Line powered

100 mA

100 mA

PT100 Temperature Sensing Module

TX9160.306

rModule

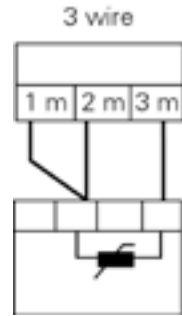
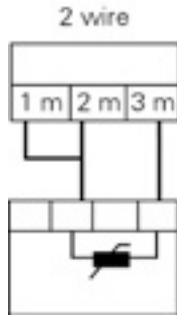

Max cable length

1.5 mm²

10 m

100 m

2.5 mm²

25 m

100 m

ON/OFF (NAMUR/CONTACT) Sensing Module

TX9160.501

rModule

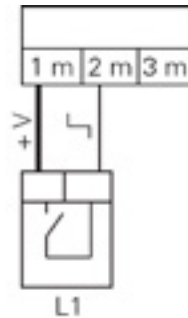
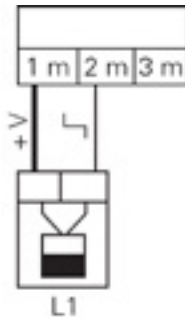
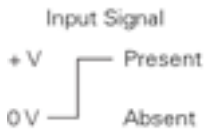

- NAMUR proximity sensors DN 19234
- Discrete fault alarm generated for OPEN CIRCUIT and SHORT CIRCUIT line condition
- Can also be used with conventional ON/OFF switches

Max. cable length

500 m

500 m

Sensor voltage

8.2 V dc via module

8.2 V dc via module

Frequency range

0 to 10 k Hz

0 to 10 k Hz

Switch Sensing Module

TX9160.502

rModule

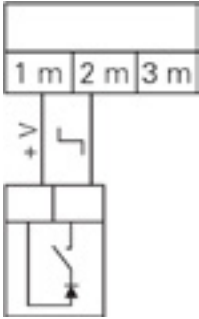
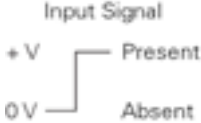

- Switches with series diode
- Detection of SHORT CIRCUIT switch line, with series diode
- Detection of OPEN CIRCUIT switch line also, when contact shunt resistor is added

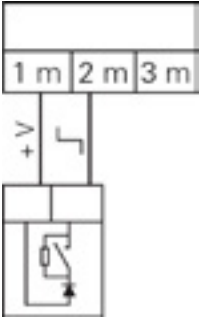

- Switches with series diode
- Detection of SHORT CIRCUIT switch line, with series diode
- Detection of OPEN CIRCUIT switch line also, when contact shunt resistor is added

Max. cable length 500 m

500 m

Sensor voltage 8.2 V dc via module

8.2 V dc via module

Frequency range 10 k Hz

10 k Hz

Checkpoint

Discrete Fault alarms generated for Open Circuit and Short Circuit line condition.

Section 4.5.6 **>>>**

3.4 Connecting in Mining and Tunnelling Areas

The Sentro 8 Sensorstation is approved intrinsically safe for use in underground mining hazardous areas, category M1.

The complete system is powered from a single approved intrinsically safe 12 V dc power source and all elements of the system, including approved sensors, can be mounted in the hazardous area.

Sensor voltage: 12 V dc
Sensor certification: Ex ia 1 M1



Checkpoint

Creepage and clearance on terminal groupings of the Sentro 8 Sensorstation are sufficient to permit the routing of circuits emanating from different intrinsically safe power supplies through the Sentro 8 Sensorstation.

Checkpoint

The outer cover of the Sentro 8 Sensorstation may be safely removed when the Sentro 8 Sensorstation is powered-up in order to replace a gas sensing eModule or to perform calibration.

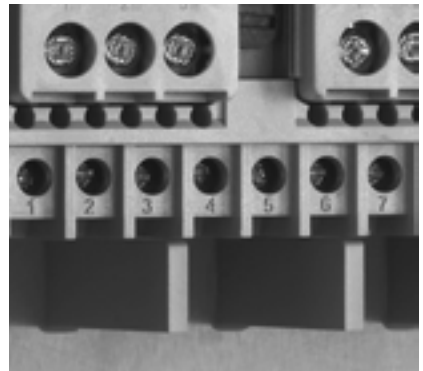

Section 6.3



Section 7.4



3.5 Sentro 8 Sensorstation Sensing Module Positions

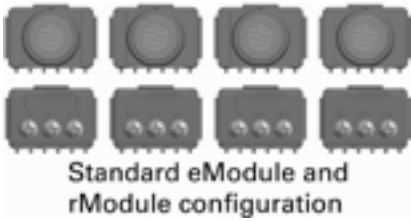

Sentro 8 eModule and rModule Configuration
The standard Sentro 8 Sensorstation will accept up to four Sentro eModules in locations A, B, C and D, plus up to four Sentro rModules in locations E, F, G and H. Sentro rModules cannot be fitted in locations A, B, C and D.

Unused gas entry ports will be sealed. The Sentro 8 Sensorstation can be adapted for non-standard configurations according to specification.

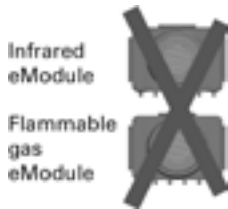

Checkpoint

To ensure equal internal power sharing, do not fit Flammable Gas eModules and Infrared eModules above one another. Locate these eModules horizontally or diagonally from one another.



Sensing Module Security Coding

Six coding slots at each module bay can be individually configured using coding stops to give a choice of 20 security codes.



Sensing Module Retainer

Sensing modules can be mechanically locked in position for added security. Secure the sensing module using a suitable screwdriver and turn the retainer screw one quarter turn clockwise.

3.6 Datacomms

The datacomms output is RS485 standard supporting Modbus protocol.



4. Setup and Calibration

4.1 Controls and Indicators

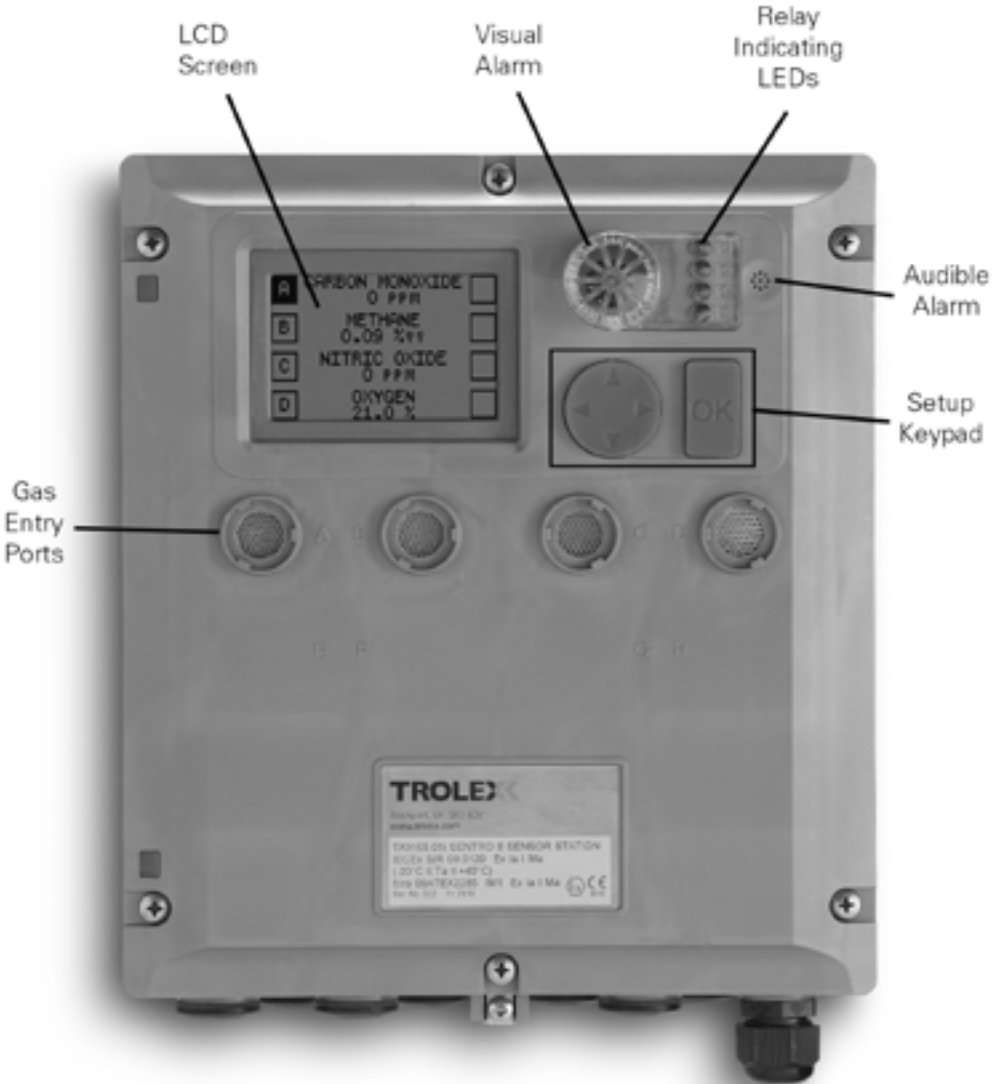

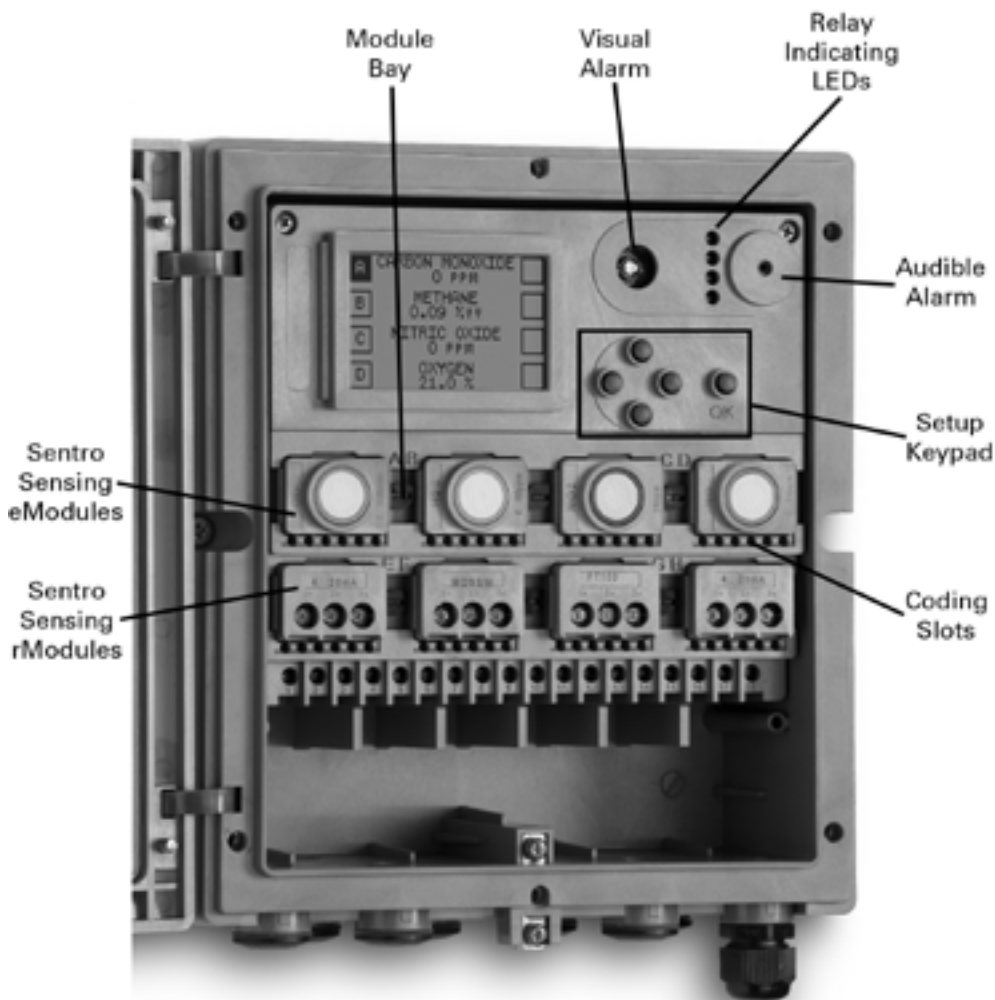

4.1.1 Navigation

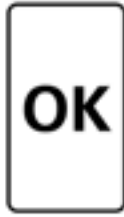

The Sentro 8 Sensorstation software is navigated using the Setup Keypad. The Setup Keypad consists of a navigation keypad and an OK key.

The navigation keypad is a four-way controller to navigate you through the software. Holding down one of the direction arrows on the navigation keypad scrolls through the menu.

The OK key is to confirm menu selections.

4.2 Start Screen

When the Sentro 8 Sensorstation is initially powered-up the Start screen will be displayed for a few seconds. The Start screen displays basic information about the Sentro system.

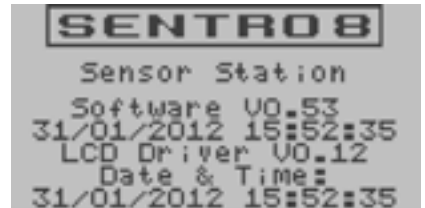

4.2.1 Base Screens

After initial power-up is completed the first of the four Base Screens will appear. The four Base Screens display the following:

- 1 & 2 - Sensor Inputs Overview - two screens, one displaying channel group A to D and the other channel group E to H
- 3 - Relay Outputs Overview - one screen displaying the current state of the four relays
- 4 - Audio/Visual Alarms Overview - one screen displaying the current state of the Audio/Visual Alarms



Use the navigation keypad to scroll through the four Base Screens.

1.

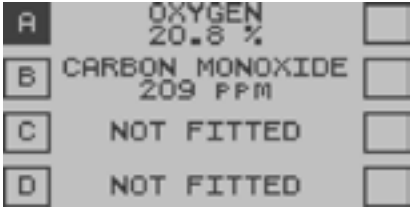

2.

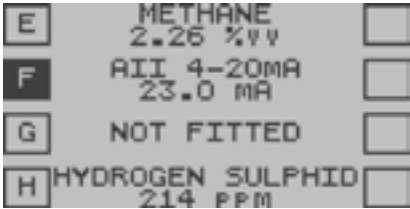

3.













4.





1 and 2 - Sensor Inputs Overview

The Sensor Inputs Overview displays the following information about the sensors fitted to the Sentro 8 Sensorstation:

- Channel address 
- Duty text 
- Signal status with units 
- Any channel exclusions 
- Setpoint 1 alarm (SP1) (General alarm) 
- Setpoint 2 alarm (SP2) (High alarm) 
- Exposure alarms (TWA/STEL) 
- Over range input signal 
- Under range input signal 
- High fault 
- Low fault 

3 - Relay Outputs Overview

The Relay Outputs Overview displays the state of the of the four relay outputs on the Sentro 8 Sensorstation:

- Output relay state
 - Power-off 
 - Power-on 

4 - Audio/Visual Alarms Overview

The Audio Visual Alarms Overview displays the alarm status.

More detailed information about Sensor Inputs, Relay Outputs and Audio/Visual Alarms can be displayed.

Use the navigation keypad, scroll through the four Base Screens of Sensor Inputs Overview (two), Relay Outputs Overview and Audio/Visual Alarms Overview to the channel you wish to view in detail and select OK.

4.2.2 Sensor Inputs Overview

The detail view of each channel is displayed on four/five screens in the following order:

- Mono View
- Exposure View - toxic gas eModule only
- Minmax View
- Trend View
- Log View

The Mono View appears first. Use the OK key to step through the detail views and back again to the Base Screens displaying the Sensor Inputs Overview 1 & 2.

Checkpoint

The direction of a step can be changed at any time by using the navigation keypad to highlight the next view required in the bottom bar.

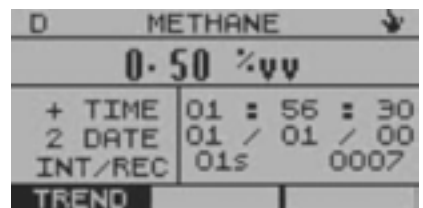
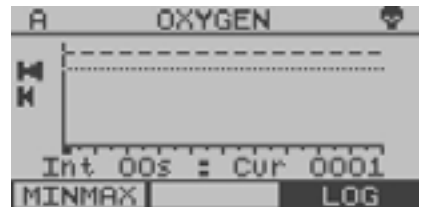
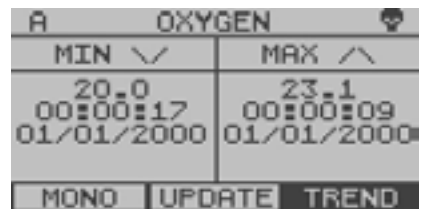
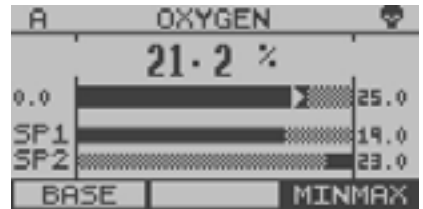

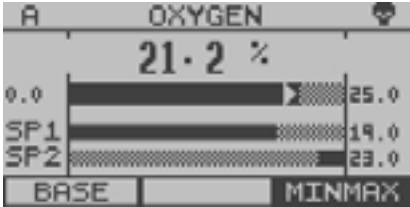

4.2.2.1 Mono View

This displays more detailed information about individual channels.

Channel Information

This is a bar graph of the input signal with lower and upper scale values on the left and right. The arrow indicates increasing/stable/ decreasing signal tendency.

Setpoint 1 (SP1) General alarm) and Setpoint 2 (SP2) (High alarm) marker with a numerical value on the right side.

Alarm Messages

- Setpoint 1 (SP1) (General alarm) or Setpoint 2 (SP2) (High alarm) On
- Setpoint 2 (SP2) (High alarm) On



- The input signal is under range



- The input signal is over range



- A location is temporarily excluded



- The input signal is low fault



- The input signal is high fault



- The STEL alarm in the eModule is activated



- The TWA alarm in the eModule is activated

Checkpoint

Scroll up or down to view the Mono View information on an adjacent input channel.

4.2.2.2 Minmax View

The Minimum and Maximum value that the signal has reached since last updated with time and date stamp.

To update the values displayed, use the navigation keypad to scroll to Update and select OK.

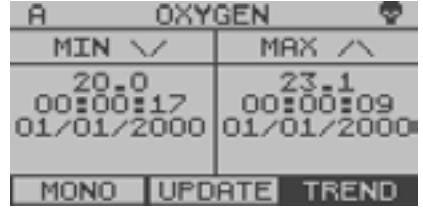

4.2.2.3 Trend View

The display field displays 100 logged readings and will jump forward in lots of ten.

Total maximum logged readings 1 to 4000.

- Setpoint 1 (SP1) (General alarm)
- Setpoint 2 (SP2) (High alarm)
- Trend cursor

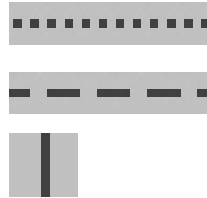
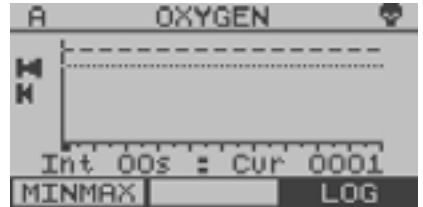

Section 4.2.2.4 >>

To Review the Trend

Use the navigation keypad, scroll up or down to review the Trend and select OK to view the Log values at the current trend cursor position. Select OK to return to Trend.

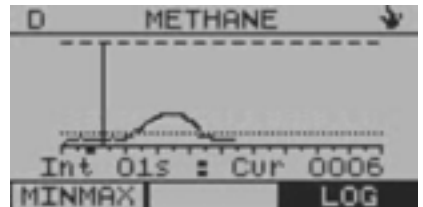

Section 4.2.2.4 >>

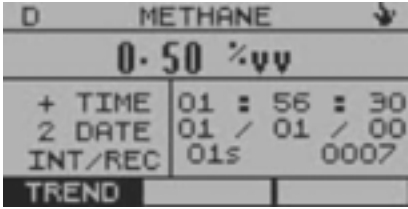

4.2.2.4 Log View

Details of the data present at the Trend cursor position selected.

Section 4.2.2.3 >>

To Review the Trend

Use the navigation keypad, scroll up or down to review the Log and select OK to view the general Trend around the current Log entry. Select OK to return to Log.

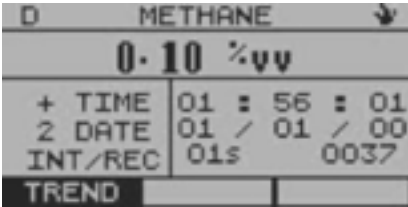

Section 4.2.2.3 >>



4.2.2.5 Exposure View

If a toxic Sentro eModule has been activated to monitor STEL and TWA exposure limits, an additional fifth view called Exposure View will appear in the Sensor Inputs Overview.

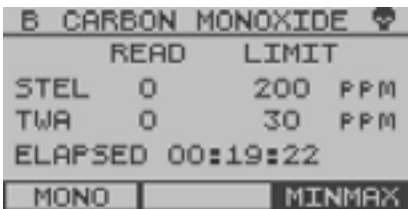

- Short term exposure limit - COSHH
- Time weighted average - COSHH
- Time elapsed into monitoring period
- Current accumulated value
- Preset alarm limits that activate the Exposure alarm signals of the eModule for STEL and TWA

STEL

TWA

ELAPSED

READ

LIMIT

Section 4.3.6



Section 4.4.4



Checkpoint

STEL: Short term exposure limit of total accumulated units over a rolling 15 minute period.

Checkpoint

TWA: Time weighted average of gas concentration over a working eight hour period.

R3	RELAY 3								X				
	A	B	C	D	E	F	G	H	1	2	3	4	↓
SP1		✓											
SP2					X								
FLT			X										
STL	✓												
TWA	✓												

4.2.3 Relay Outputs Overview

Information is displayed about the signals that are assigned to this relay from the sensing modules and other relay outputs.

Use the navigation keypad, scroll through the Base Screens to Relay Outputs Overview.

Scroll to the Relay Channel you are interested in and select OK.

- A to ↓: Origin of incoming signal
- SP1 to TWA: Type of incoming signal



The screen prompts are as follows:

- The incoming signal is a Set function
- The incoming signal is a Reset function
- Non valid function

AV	AUDIO/VISUAL								X				
	A	B	C	D	E	F	G	H	1	2	3	4	↓
SP1	≡	-											
SP2	≡		=										
FLT													≡
STL													
TWA													

4.2.4 Audio/Visual Alarms Overview

Information is displayed about the signals that are assigned to this audio/visual alarm from the sensing modules and the other relay outputs.

Use the navigation keypad, scroll through the Base Screens to the Audio/Visual Alarm Overview and select OK.

The screen displays the severity level of the incoming signal, one bar is lowest and three bars is highest.

4.3 Main Setup Menu

From the Base Screens press and hold down the up arrow on the navigation keypad. After a few seconds the Main Setup Menu will appear. The available options are as follows:

- Security
 - Check code
 - Set code
- Display
 - Contrast
 - Auto scroll
 - Backlight
 - Confidence
- Time and Date
- Log
- Datacomms
- Reset Exposure



4.3.1 Security

To Access the Security Menu

From the Main Setup Menu, use the navigation keypad, scroll to Security and select OK.

Check Code

From the Security Menu, use the navigation keypad, scroll to Check Code and select OK.

Scroll to Yes or No and select OK. Scroll to Set or Quit and select OK.

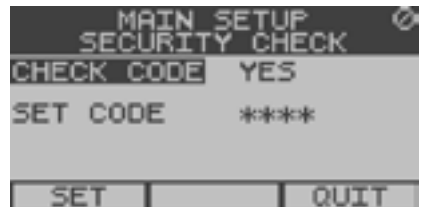

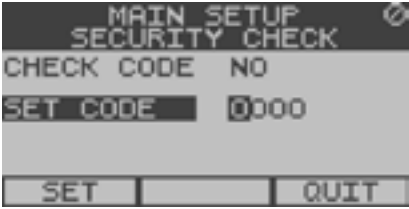

To Set the Security Code

Checkpoint
The factory set security code is 0000.

From the Security Menu use the navigation keypad to scroll to Set Code and select OK.

Use the navigation keypad, scroll up or down on the first digit to the required number, scroll right to the next digit, repeat for all four digits and select OK.

Use the navigation keypad, scroll to Set or Quit and select OK.



Checkpoint
To Open the Security Barrier When Set
Use the navigation keypad, scroll up or down on the first digit to the required number, scroll right to the next digit, repeat for all four digits and select OK.

4.3.2 Display

To Access the Display Settings Menu

From the Main Setup Menu use the navigation keypad, scroll to Display and select OK.

To Adjust the Display Contrast

From the Display Settings Menu use the navigation keypad, scroll to Contrast and select OK.



Use the navigation keypad, scroll left or right to adjust the Display contrast level and select OK.

Use the navigation keypad, scroll to Set or Quit and select OK.

To Adjust the Display Scrolltime

Checkpoint

The Base Screen can be configured to automatically scroll between the two channel groups - A to D and E to H. The time interval between scrolling is adjustable and this is Scrolltime.

From the Display Settings Menu, use the navigation keypad, scroll to Scrolltime and select OK.

Use the navigation keypad, scroll up or down on the first digit, scroll right to the second digit, repeat for the second digit and select OK.

Use the navigation keypad, scroll to Set or Quit and select OK.

To Set the Display Backlight On/Off

From the Display Settings Menu, use the navigation keypad scroll to Backlight and select OK.

Use the navigation keypad, scroll up or down to set the Backlight On or Off and select OK.

Use the navigation keypad, scroll to Set or Quit and select OK.



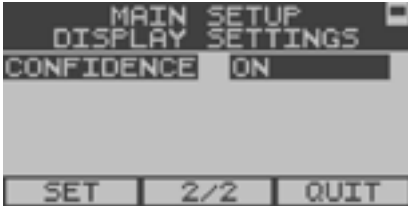

To Set the Confidence Alert On/Off

From the Display Settings Menu, use the navigation keypad, scroll to Confidence and select OK.

Use the navigation keypad, scroll up or down to set the Confidence Alert On or Off and select OK.

Use the navigation keypad, scroll to Set or Quit and select OK.

Checkpoint

Trox strongly recommends that the Confidence Alert is set On at all times to indicate to users that the Sentro 8 is functioning correctly.



4.3.3 Time and Date

To Access the Time and Date Setup Menu

From the Main Setup Menu use the navigation keypad, scroll to Time and Date and select OK.

To Adjust the Time

From the Time and Date Setup Menu, use the navigation keypad, scroll to Time and select OK.

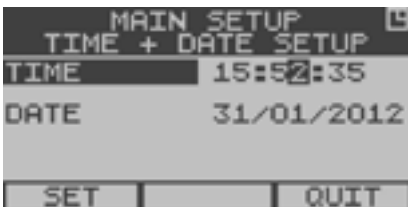

Use the navigation keypad, scroll up or down on the first digit to the required time, scroll right to the next digit. Repeat the above for all six digits in Time and select OK.

Use the navigation keypad, scroll to Set or Quit and select OK.

To Adjust the Date

From the Time and Date Setup Menu, use the navigation keypad, scroll to Date and select OK.

Use the navigation keypad, scroll up or down on the first digit to the required date, scroll right to the next digit. Repeat the above for all eight digits in Date and select OK.

Use the navigation keypad, scroll to Set or Quit and select OK.



Checkpoint

The Sentro 8 internal clock is powered by a miniature lithium battery. The battery has a life expectancy in excess of 10 years.

4.3.4 Log

Readings of data for each channel will be continuously recorded at predetermined intervals.

Checkpoint

By changing Time Units and Log Period in combination it is possible to configure a Log Period of between 1 second and 99 hours.

To Access the Log Setup Menu

From the Main Setup Menu, use the navigation keypad, scroll to Log and select OK.

To Change the Time Units

From the Log Setup Menu, use the navigation keypad, scroll to Time and select OK.

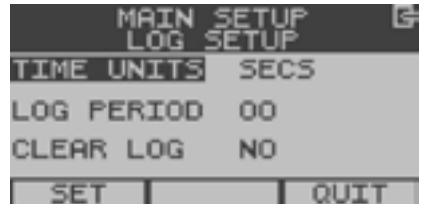



Use the navigation keypad, scroll up or down to change the time units to Secs, Mins or Hours and select OK.

Use the navigation keypad, scroll to Set or Quit and select OK.

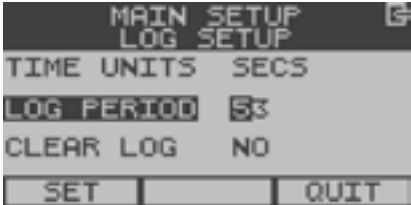

To Change the Log Period

From the Log Setup Menu, use the navigation keypad, scroll to Log Period and select OK.

Use the navigation keypad, scroll up or down to change the Log Period digits and select OK.

Use the navigation keypad, scroll to Set or Quit and select OK.

To Clear the Log

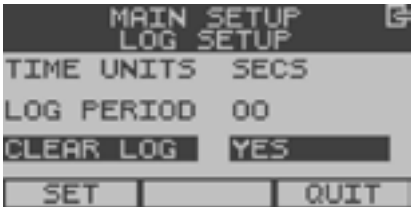

Caution
Always clear the Log after any fundamental changes have been made to the Sentro 8 Sensorstation.

- Replacement of eModule or rModule
- Change of Log Period
- Change of Remote Sensor

From the Log Setup Menu, use the navigation keypad, scroll to Clear Log and select OK.

Use the navigation keypad, scroll to Yes or No and select OK.

Use the navigation keypad, scroll to Set or Quit and select OK.

4.3.5 Datacomms Protocol

The protocol characteristics required for the Modbus datacomms can be setup where the Sentro 8 Sensorstation is being integrated into a wider communication network or to interface with a PC or SCADA system.

Data Protocol	Modbus
Format	Binary
Databits	8
Stopbits	1
Parity	None
Data rate	300/600/1200/2400/4800/9600/14400/19200/28800/38400/57600/115200
Address	1 to 99
TX On	0 to 99 ms
TX Off	0 to 99 ms
Duplex	Half

To Access the Datacomms Setup Menu
From the Main Setup Menu, use the navigation keypad, scroll to Datacomms and select OK.

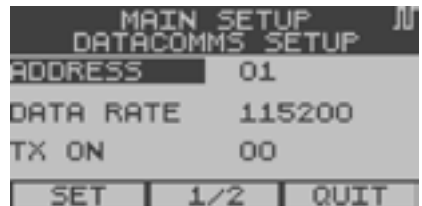

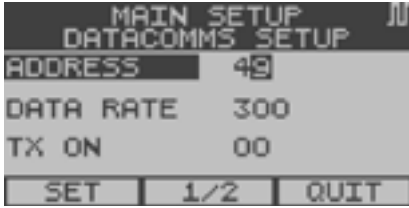

To Change the Address

From the Datacomms Setup Menu, use the navigation keypad, scroll to Address and select OK.

Use the navigation keypad, scroll up or down on the first digit to the required Address, scroll right to the second digit. Repeat the above for the second digit in Address and select OK.

Use the navigation keypad, scroll to Set or Quit and select OK.

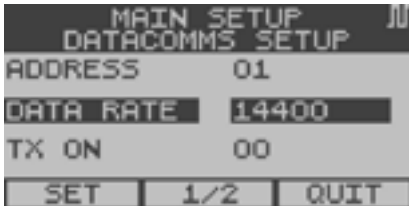

To Change the Data Rate

From the Datacomms Setup Menu, use the navigation keypad, scroll to Data Rate and select OK.

Use the navigation keypad, scroll up or down to the required Data Rate and select OK.

Use the navigation keypad, scroll to Set or Quit and select OK.

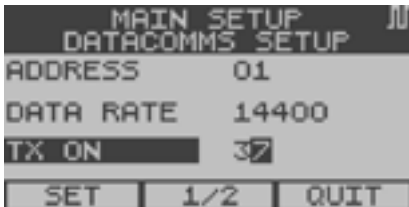

To Change the TX On Setting

From the Datacomms Setup Menu, use the navigation keypad, scroll to TX On and select OK.

Use the navigation keypad, scroll up or down on the first digit to the required TX On number, scroll right to the second digit. Repeat the above for the second digit in TX On and select OK.

Use the navigation keypad, scroll to Set or Quit and select OK.

To Change the TX Off Setting

From the Datacomms Setup Menu, use the navigation keypad, scroll to TX Off and select OK.

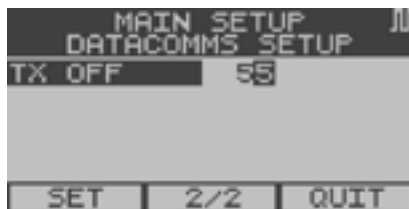

Use the navigation keypad, scroll up or down on the first digit to the required TX Off number, scroll right to the second digit. Repeat the above for the second digit in TX Off and select OK.

Use the navigation keypad, scroll to Set or Quit and select OK.

4.3.6 Reset Exposure

Checkpoint

STEL and TWA that has accumulated in any toxic gas Sentro eModules will be simultaneously reset to zero.



Checkpoint

The accumulated STEL and TWA levels should only be reset by authorised personnel.

To Access the Reset Exposure Menu

From the Main Setup Menu, use the navigation keypad, scroll to Reset Exposure and select OK.

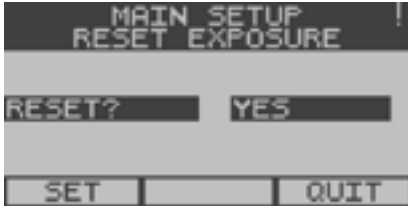

To Reset Exposure

From the Reset Exposure Menu, select OK, use the navigation keypad, scroll to Yes or No and select OK.

Use the navigation keypad, scroll to Set or Quit and select OK.

4.4 Sentro eModule Setup

This displays more detailed information about the configuration of individual eModule channels.

From the Base Screens, use the navigation keypad, scroll to the required channel A, B, C or D, press and hold down the left arrow on the navigation keypad. After a few seconds the Sentro eModule Setup Menu will appear. The options are as follows:

- Calibrate
 - Zero
 - Set Calibration Gas
 - Span
- Setpoint 1
 - Activate
 - Level
 - Assign
- Setpoint 2
 - Activate
 - Level
 - Assign
- Assign Fault
- Exposure
- Status
 - Exclude

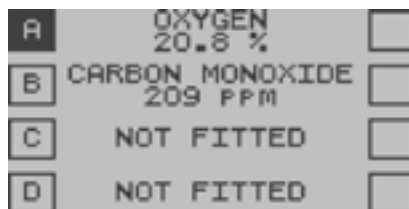

4.4.1 Sentro eModules Calibrate

Checkpoint

The standard configuration for a Sentro 8 has eModules fitted in locations A, B, C and D. It is possible that eModules are fitted in locations E, F, G and H but this is a factory fitted configuration. If you are unsure which modules you have fitted to your Sentro 8, look at the Sensor Inputs Overview for channels group E to H and see if gas types are displayed. If gas types are displayed you have eModules fitted in channel group E to H. If you are still unsure contact: service@trolex.com for assistance.

Checkpoint

Ensure the area where the equipment is being calibrated is well ventilated. Observe appropriate Health and Safety legislation and applicable local procedures when handling test gases.

Checkpoint

When calibrate is selected the eModule will output a fixed value of 0.00. This prevents the possibility of false alarm signals being activated in the monitoring equipment during the calibration process (20% will be output for an oxygen sensor).



Fit a gas hood to the corresponding port of the eModule being calibrated. Connect the gas application tube from the clean air test gas cylinder to the gas hood fitted to the eModule being calibrated.

Zero

From the Sentro eModule Setup Menu, use the navigation keypad, scroll to Calibrate and select OK.

If a Security Code has been enabled you will be prompted to enter it, enter the Security Code and select OK.

The screen will display an arbitrary reading.

Open the valve and apply clean air from the test gas cylinder at a rate of 1 litre/min to clear any gas from the sensor.

Wait for the reading to settle at a stable value, not necessarily 0.

When stable select OK to Zero the reading. If the Zero point continues to shift then select OK again.

Close the valve and stop the supply of clean air.

Disconnect the application tube from the gas port.

Use the navigation keypad, scroll to Span and select OK.

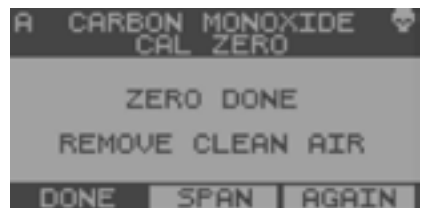
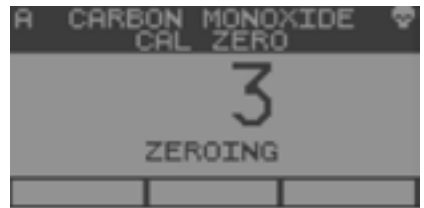
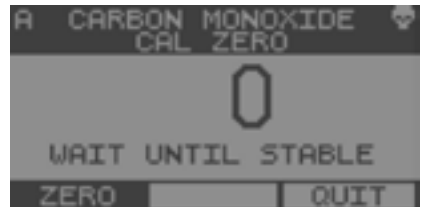

Check

The screen displays the Span value of calibration gas that the Sentro 8 Sensorstation expects to be used during calibration.

Check the Span value of gas displayed against the value on your calibration gas cylinder.

If the two values match then proceed to the Calibrate Span procedure.

If they do not match then Change the value as follows:

Use the navigation keypad, scroll to Change and select OK.

With Expected highlighted select OK.

Use the navigation keypad, scroll up or down on the first digit to the required Span value on your calibration gas cylinder. Scroll right to the second digit. Repeat the above for the second and third digit in Span and select OK.

Scroll to Accept and select OK.

Continue with Calibrate Span as described in the following section.

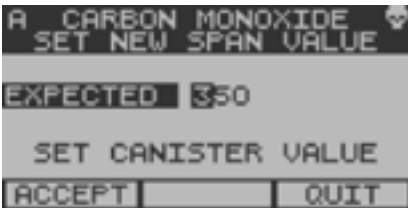
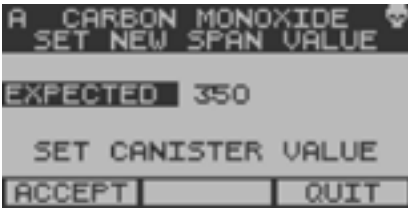
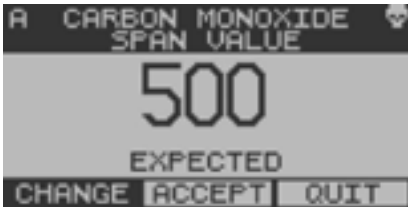

Calibrate Span - Using a Calibration Gas of an Expected Value

Connect the gas application tube from the calibration gas cylinder to the gas hood fitted to the corresponding gas port of the eModule being calibrated.

Scroll to Accept and select OK.

Open the valve and apply calibration gas at a rate of 1 litre/min to clear any clean air from the sensor.

Wait for the reading to settle at a stable value, this is not necessarily the calibration gas value and select OK when stable.

Select OK again if the displayed value continues to shift.

Use the navigation keypad, scroll to Done or Quit in the toolbar and select OK.

Shut the valve and stop the supply of calibration gas to the sensor. Disconnect the application tube from the gas hood and remove the gas hood.

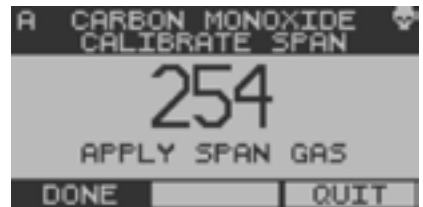
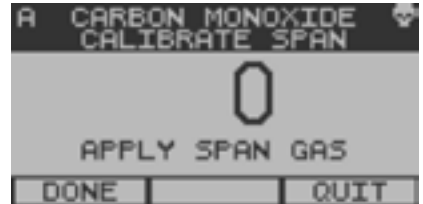

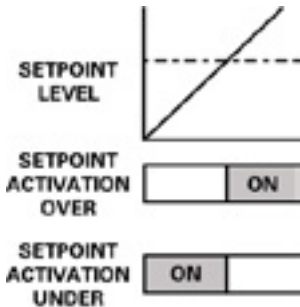

4.4.2 Setpoint 1 and Setpoint 2

Each input channel A to H has two Setpoint On alarm states - Setpoint 1 (SP1) (General alarm) and Setpoint 2 (SP2) (High alarm).

The available options are as follows:

- Activate
- Level
- Assign

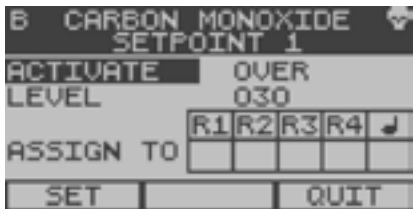
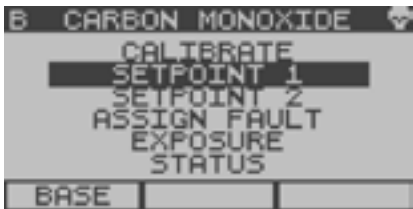

To Access the Setpoint 1 or Setpoint 2 Setup Menu

From the Sentro eModule Setup Menu, use the navigation keypad, scroll to Setpoint 1 or Setpoint 2 and select OK.

If a Security Code has been enabled you will be prompted to enter it, enter the Security Code and select OK.

Activate

The Activate mode of Setpoint 1 and Setpoint 2 can be setup to preference.

From the Setpoint 1 or Setpoint 2 Setup Menu, use the navigation keypad, scroll to Activate and select OK.

Use the navigation keypad, scroll to Over or Under and select OK.

Use the navigation keypad, scroll to Set or Quit and select OK.

Level

The operating Level of Setpoint 1 and Setpoint 2 can be setup to preference.

From the Setpoint 1 or Setpoint 2 Setup Menu, use the navigation keypad, scroll to Level and select OK.

Use the navigation keypad, scroll up or down on the first digit to the required Level value. Scroll right to the second digit. Repeat the above for the second and third digit in Level and select OK.

Use the navigation keypad, scroll to Set or Quit and select OK.

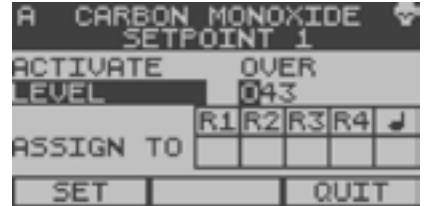



Assign Setpoint

The Setpoint 1 or Setpoint 2 On alarm state can be assigned to the following:

- Relay 1 output
- Relay 2 output
- Relay 3 output
- Relay 4 output
- The on-board audio/visual alarm

The Assign To of Setpoint 1 and Setpoint 2 can be setup to preference.

From the Setpoint 1 or Setpoint 2 Setup Menu, use the navigation keypad, scroll to Assign To and select OK.

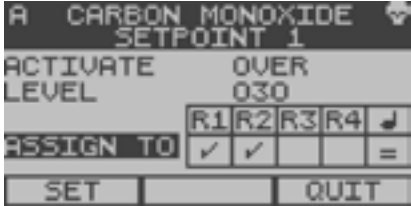
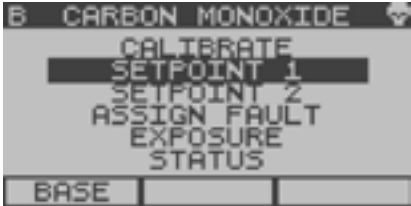

The screen prompts are as follows:



- Cursor
- Power-up the selected relay
- Reset a latched relay
- Audio alarm severity

4.4.3 Assign Fault

Each input channel A to H has a fault alarm output state:

- Analogue input signal over range
- Analogue input signal under range
- Module fault

To Access Assign Fault

From the Sentro eModule Setup Menu, use the navigation keypad, scroll to Assign Fault and select OK.

If a Security Code has been enabled you will be prompted to enter it, enter the Security Code and select OK.

The screen prompts are as follows:

- Cursor
- Power-up the selected relay
- Reset a latched relay
- Audio alarm severity

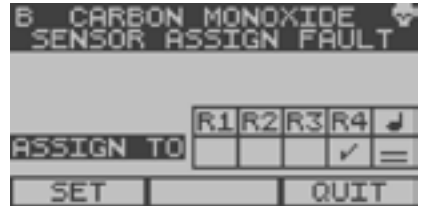

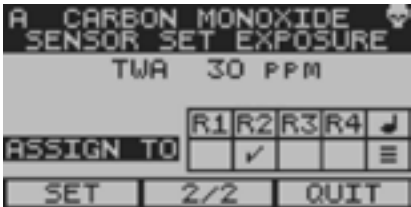
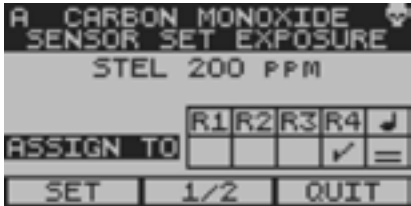

4.4.4 Assign Exposure Alarm

When a toxic gas Sentro eModule equipped with STEL and TWA processing is enabled at a location, an additional menu item Exposure will appear.

To Access Exposure

From the Sentro eModule Setup Menu, use the navigation keypad, scroll to Exposure and select OK.

If a Security Code has been enabled you will be prompted to enter it, enter the Security Code and select OK.

The preset limits of STEL and TWA can be viewed. STEL and TWA alarm states can be assigned to the following:

- Relay 1 output
- Relay 2 output
- Relay 3 output
- Relay 4 output
- The on-board audio/visual alarm

The screen prompts are as follows:

- Cursor
- Power-up the selected relay
- Reset a latched relay
- Audio alarm severity



Section 4.3.6

Checkpoint
 Reset the accumulated STEL and TWA data in accordance with section 4.3.6.

4.4.5 Status

Exclude

A Sentro eModule can be excluded to disable alarm activity.

To Access Exclude

From the Sentro eModule Setup Menu, use the navigation keypad, scroll to Status and select OK.

If a Security Code has been enabled you will be prompted to enter it, enter the Security Code and select OK.

From the Status Menu, select OK, use the navigation keypad, scroll to Yes or No and select OK.

Use the navigation keypad, scroll to Set or Quit and select OK.

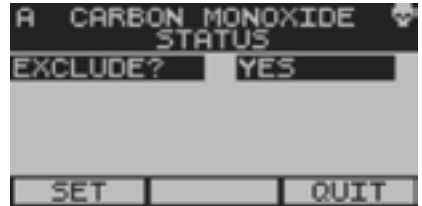

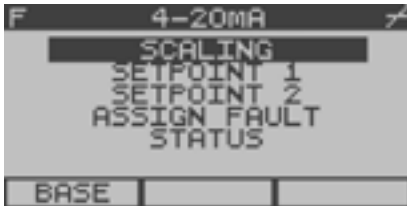
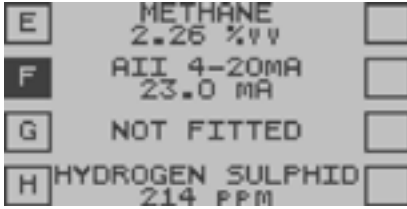

4.5 Sentro rModule Setup

This displays more detailed information about the configuration of individual rModule channels.

From the Base Screens, use the navigation keypad and scroll to the required channel E, F, G or H. Press and hold down the left arrow on the navigation keypad. After a few seconds the Sentro rModule Setup Menu will appear. The options are as follows:

- Calibrate - if PT100 fitted
- Scaling
 - Sig Fig
 - Lower
 - Upper
 - Units
 - Update
 - Text
- Setpoint 1
 - Activate
 - Level
 - Assign To
 - Hysteresis
 - On Delay
 - Off Delay
- Setpoint 2
 - Activate
 - Level
 - Assign To
 - Hysteresis
 - On Delay
 - Off Delay
- Assign Fault
 - Assign To
- Status

Checkpoint

The standard configuration for a Sentro 8 has rModules fitted in locations E to H. It is possible that eModules are fitted in locations E to H but this is a factory fitted configuration. If you are unsure which modules you have fitted to your Sentro 8, look at the Sensor Inputs Overview for channels group E to H and see if gas types are displayed. If gas types are displayed you have eModules fitted in channel group E to H. If you are still unsure contact: service@trolex.com for assistance.

4.5.1 Scaling

The various characteristics of the analogue input signal scale values can be configured.

To Access Scaling

From the Sentro rModule Setup Menu, use the navigation keypad, scroll to Scaling and select OK.

If a Security Code has been enabled you will be prompted to enter it, enter the Security Code and select OK.

Sig Fig

The position of the decimal point can be shifted along the displayed number to the best Significant Figure to suit the particular sensor signal being monitored and its optimum measuring range.

This can be used to eliminate digit flicker and redundant decimal places.

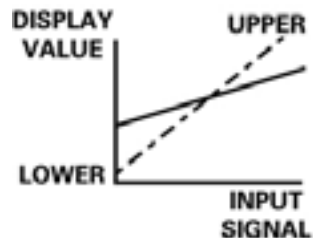
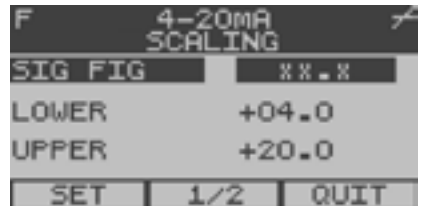
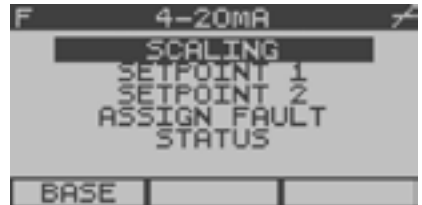

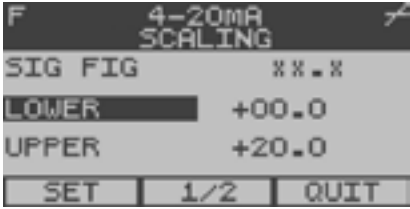

Lower - Upper

Set the desired Lower and Upper limits of the displayed reading for a given magnitude of input signal scan. This can be any numeric value and the polarity can be any negative value through to any positive value.

Checkpoint
Enter the preferred Sig Fig before setting the Lower and Upper values.

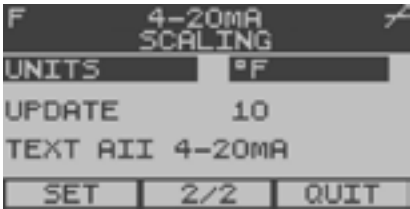

Units

A menu of most standard engineering units is available for adding on to the signal value displayed.

An option called Create User Defined Units will appear in the units menu choice. Specific user defined units can be configured. Up to four characters of text can be entered into the Sentro 8.

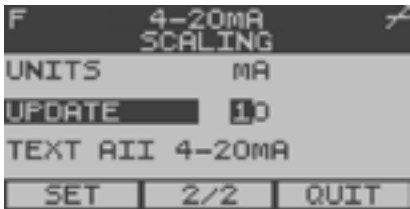

Update

The Input Signal is sampled at pre-determined intervals and the Update time period is adjustable. Signal values are averaged between samples.

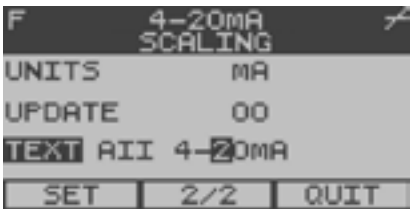
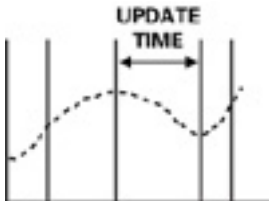

Text

Duty Text can be entered to denote the input duty or a tag reference of the input device.

4.5.2 Setpoint 1 and Setpoint 2

Each input channel E to H has two Setpoint On alarm states - Setpoint 1 (SP1) (General alarm) and Setpoint 2 (SP2) (High alarm).

To Access Setpoint 1 and Setpoint 2

From the Sentro rModule Setup Menu, use the navigation keypad, scroll to Setpoint 1 or Setpoint 2 and select OK.

If a Security Code has been enabled you will be prompted to enter it, enter the Security Code and select OK.

Activate

The Activate mode of Setpoints can be setup to preference.

From the Setpoint 1 or Setpoint 2 Setup Menu, use the navigation keypad, scroll to Activate and select OK.

Use the navigation keypad, scroll to Over or Under and select OK.

Use the navigation keypad, scroll to Set or Quit and select OK.

Level

The operating Level of Setpoints can be setup to preference.

From the Setpoint 1 or Setpoint 2 Setup Menu, use the navigation keypad, scroll to Level and select OK.

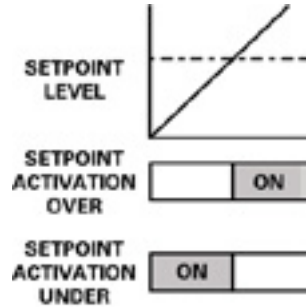

Use the navigation keypad, scroll up or down on the first digit to the required Level value. Scroll right to the second digit. Repeat the above for the second and third digit in Level and select OK.

Use the navigation keypad, scroll to Set or Quit and select OK.

Assign To

The Setpoint On alarm state can be assigned to the following:

- Relay 1 output
- Relay 2 output
- Relay 3 output
- Relay 4 output
- The on-board audio/visual alarm

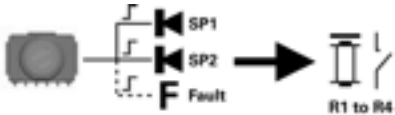

The Assign To of Setpoint 1 (SP1) (General alarm) and Setpoint 2 (SP2) (High alarm) can be setup to preference. The screen prompts are as follows:

- Cursor
- Power-up the selected relay
- Reset a latched relay
- Audio alarm severity

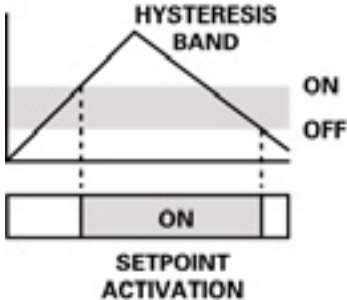

Hysteresis

Hysteresis is the deadband between the setpoint Activating On and Activating Off as the input signal increases and decreases.

Checkpoint
 The Activating Off level is defined with respect to the programmed Activating On setpoint level.

On Delay - Off Delay

The Activation On of the setpoint can be delayed by an adjustable time period (t On).

The Activation Off of the setpoint can also be delayed by an adjustable time period (t Off).

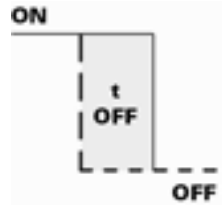
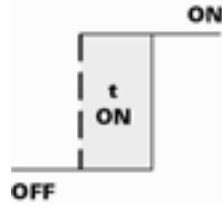

4.5.3 Assign Fault

Each input channel E to H has a Fault alarm output state.

- Analogue input signal over range
- Analogue input signal under range
- Module fault

To Access Assign Fault

From the Sentro rModule Setup Menu, use the navigation keypad, scroll to Assign Fault and select OK.

If a Security Code has been enabled you will be prompted to enter it, enter the Security Code and select OK.

Assign to

The Fault state can be assigned to the following:

- Relay 1 output
- Relay 2 output
- Relay 3 output
- Relay 4 output
- The on-board audio/visual alarm

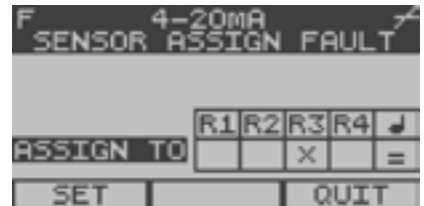
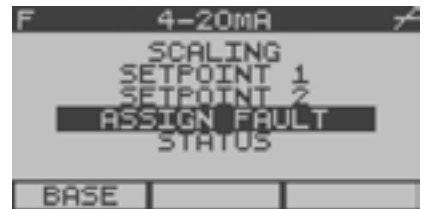



The screen prompts are as follows:

- Cursor
- Power-up the selected relay
- Reset a latched relay
- Audio alarm severity

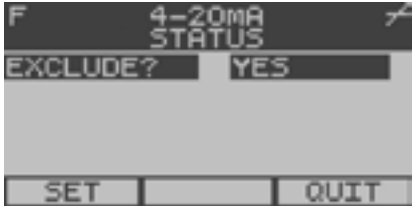
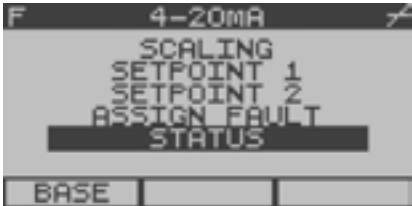

4.5.4 Status

Exclude

A selected Sentro rModule can be excluded to disable alarm activity

To Access Status

From the Sentro rModule Setup Menu, use the navigation keypad, scroll to Status and select OK.

If a Security Code has been enabled you will be prompted to enter it, enter the Security Code and select OK.

Exclude

From the Exclude Menu, select OK, use the navigation keypad, scroll to Yes or No and select OK.

4.5.5 Calibrate PT100

If a PT100 Temperature rModule is fitted Calibrate will appear in the menu. Trim the signal to suit site measured conditions.

4.5.6 Setup of an On/Off Input rModule

The On/Off Sentro rModules will respond to signals from simple switching sensors such as thermostats, pressure switches and interlock limit switches. The switches may be conventional contacts or NAMUR proximity sensors.

Setup functions are the same as for Analogue input rModules.

Mono View

The Mono View will display the Present/Absent status of the input switch signal.

4.5.7 Setup of an On/Off Diode Input rModule

The input is also configured to accept an input from switching devices such as pressure switches, limit switches, thermostats, etc with a diode connected in series at the remote point.

This rModule has the same basic functions as the On/Off Input rModule.

Section 4.5.6



In addition it will respond to Open Circuit and Short Circuit conditions by generating a discrete High Fault alarm.

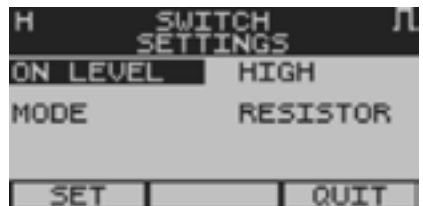
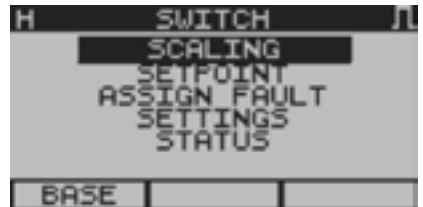
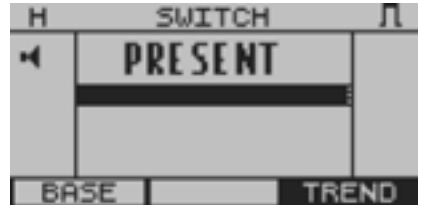
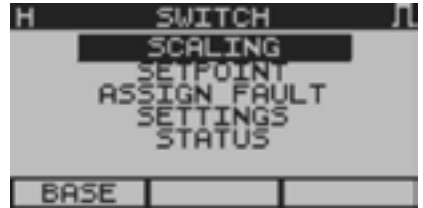

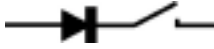

Mode - No Resistor

The input is configured to accept an input from switching devices such as pressure switches, limit switches, thermostats, etc with a diode connected in series at the remote point. The rModule will respond to a short circuit condition occurring by generating a Low Fault condition.

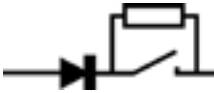

Mode - Resistor

In addition to the operation of the No Resistor mode, when a resistor is connected in parallel with the switching device at the remote point, the rModule will respond to the open circuit condition occurring by generating a Low Fault condition.

4.6 Output Relays Setup

The Sentro 8 Sensorstation is equipped with four integral output relays for external alarm and control purposes.

Initiating control commands can be assigned to any of the four relays:

- From Setpoint 1 (SP1) (General alarm) on modules A to H
- From Setpoint 2 (SP2) (High alarm) on modules A to H
- From a Fault on modules A to H
- From other relays fault monitoring
- From the A/V Alarm fault monitoring

The response characteristics of each of the relays can be setup according to functional requirements.



Checkpoint

The LED relay indicator is on when the relay is powered-down (Alarm State).

4.6.1 Mode

Each relay can be independently setup to respond in three different ways.

Auto Reset

The output relay will power-down when the Setpoint Command is activated On and power-up when the Setpoint Command is activated Off.

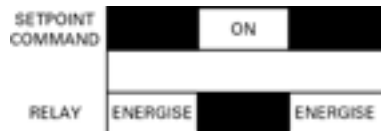

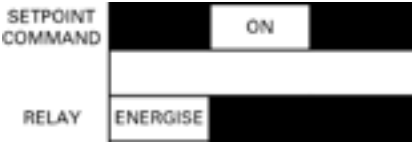

Latch

The output relay will power-down when the Setpoint Command is activated On and Latch until reset.

To reset a latched relay:

Section 6.5 

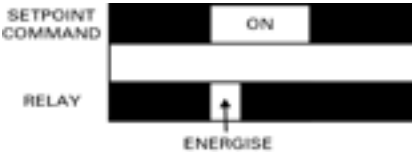

Pulse

The output relay will power-up when the Setpoint Command is activated On and power-down after an adjustable time.

4.6.2 Pulse Time

Set the length of relay pulse when operating in Pulse Mode, 0 to 25 seconds.

4.6.3 Assign Fault

The function of each relay is monitored for correct operation and the Setpoint On alarm state can be assigned to:

- Relay 1 output
- Relay 2 output
- Relay 3 output
- Relay 4 output
- The on-board audio/visual alarm

The screen prompts are as follows:



- Cursor
- Power-up the selected relay
- Reset a latched relay
- Audio alarm severity

4.6.4 And Function

A relay can be set to power-up only when several Setpoint Commands are present at the same time, so creating an And decision.

Voting Inputs

If Setpoint Commands are assigned to the relay from for example, 4 assignors, set the And function at 2. The relay will activate on a vote of any 2 out of 4.

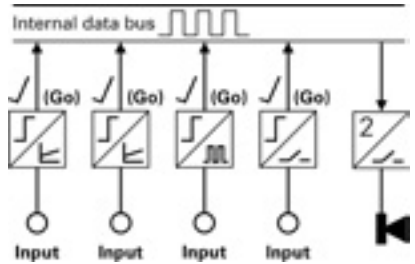

4.6.5 Text

Duty text can be entered to denote the input duty or a tag reference of the input device.

5. Audio/Visual Alarm References

All alarm signals and fault signals can be assigned to operate the inbuilt audio visual alarm in any combination.

Alarms are generated from:

- From Setpoint 1 (SP1) (General alarm) on sensing modules A to H
- From Setpoint 2 (SP2) (High alarm) on sensing modules A to H
- From a Fault on sensing modules A to H
- Relays 1 to 4 fault monitoring

5.1 Alarm Severity Selection

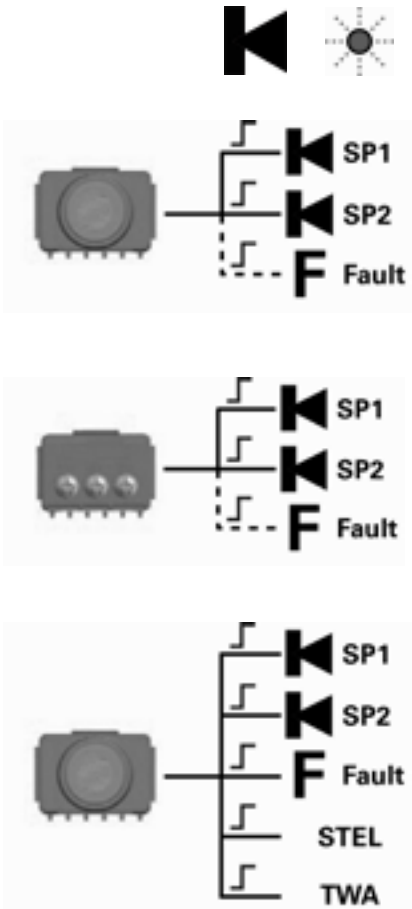

	General Alarm Slow repeating pulse	
	Warning Alarm Faster, double repeating pulse	
	Critical Alarm Faster, insistent pulse	
	Confidence Alert To indicate that the Sentro 8 Sensorstation is On and functioning	

Checkpoint

To view an Alarm Event and mute the Audible Alarm, enter the Mono View to view detailed information about the Alarm Event. This action will also mute the audible alarm.

5.2 Assign Fault

The Audio/Visual indicators are equipped with self function monitoring and will generate a Fault signal if a device failure is detected.

The Fault signal will be generated at the moment when the Audio/Visual alarm is activated On.

The Fault state can be assigned to:

- Relay 1 output
- Relay 2 output
- Relay 3 output
- Relay 4 output

The screen prompts are as follows:

- Cursor
- Power-up the selected relay



6. Diagnostics

6.1 Over Range Indication on a Pellistor Gas Sensing eModule

Incorrect readings will be given by a pellistor gas sensing eModule if it is exposed to gas concentrations that exceed its normal working range.

When over range is detected on a pellistor gas sensing eModule the Sentro 8 Sensorstation will switch into Overrange Lock.

The screen will display the message Pell Over.

The transmitted output data will be clamped at full scale.

The pellistor in the gas sensing eModule will be switched into a protect state to prevent oxidation damage.

To Reset

Check that the gas has cleared.

Remove the eModule, wait five seconds and refit the eModule.

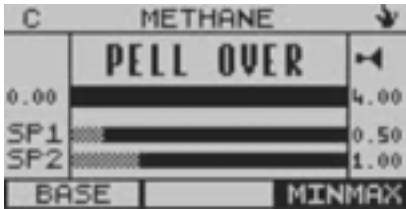

6.2 Absent Sensing Module Message

When the Sentro 8 Sensorstation is first switched on, or a sensing module is removed during normal operation, the screen will display the message:

- Sensor Missing

If a sensing module has not been fitted within a period of 10 seconds, the screen will display the message:

- Not Fitted

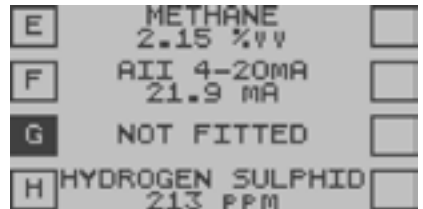
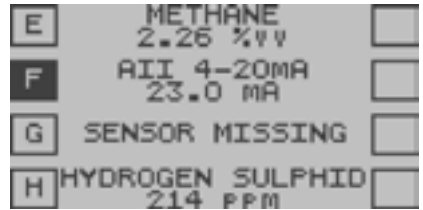

6.3 Replacing a Sentro Sensing Module

If a Sentro sensing module is removed and replaced with a sensing module of the same type, then the Sentro 8 Sensorstation will first request permission to accept the new sensing module configuration or write the configuration data of the previous sensing module into the new sensing module.

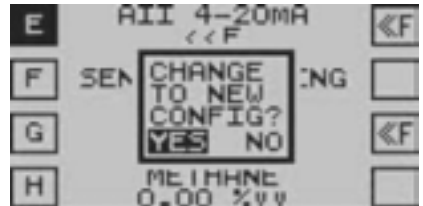

If a Sentro sensing module is removed and replaced with a sensing module of a different type, then the Sentro 8 Sensorstation will first request permission to proceed.

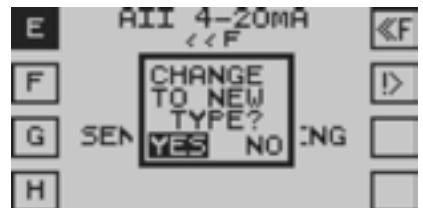

Section 7.4 **>>**

```

SYSTEM STOPPED
LOW SUPPLY VOLTAGE
RECTIFY PROBLEM
AND REBOOT

```

6.4 Low Supply Voltage

A warning message will appear when the supply voltage falls below a safe working level.

```

R2| RELAY 2 | X
RELAY IS LATCHED
SIGNAL IS ON
BASE | | DIAGS

```

6.5 Latched Relay Message and Relay Reset

Use the navigation keypad and scroll through the Base Screens to the Relay Outputs Overview.

```

R2| RELAY 2 | X
RELAY IS LATCHED
SIGNAL IS OFF
BASE | RESET | DIAGS

```

Select the Relay Channel you are interested in and select OK.

The relay may be Reset if the initiating signal is absent.

Scroll to Reset and select OK.

7. Maintenance

7.1 Sentro eModule and rModules

Sentro eModules and rModules are conveniently replaced, as they have a pre-calibrated standardised output signal. They can be replaced in seconds - eliminating the need for precision calibration facilities.



7.2 Trolex calibration recommendation statement

Methane and Hydrocarbon gas sensors often perform an important safety function and periodic calibration is an essential part of maintaining safety integrity.

- Pellistor gas sensors have a known ZERO and SPAN movement related to time, level of exposure to gas, and the nature of the environment.
- Trolex recommend that these sensors are 'Bump Tested' with a suitable test gas at regular intervals. This should be carried out in compliance with local requirements, or once per month will normally be adequate. Calibrate the sensor if necessary, or as a minimum every 6 months, to ensure correct operation.
- All other gas sensor types should also be bump tested with a suitable test gas at an interval in line with the site/industry health and safety standards and calibrated as necessary, or as a minimum every 6 months, to ensure correct operation.



Checkpoint

If there is a discrepancy of greater than 5% of reading then recalibrate the appropriate eModule of the Sentro 8 Sensorstation.

Section 4.4.1 

Or consider replacing the eModule.

Section 7.4 

Checkpoint

If there is a discrepancy of greater than 5% of reading then consider changing the gas sensing eModule.

Section 7.4 

Checkpoint

- Ensure that the appropriate Health and Safety guidelines and applicable local procedures are followed when handling test gases.
- The ambient temperature should be between +20 and +30°C during the checking procedure.
- Ensure the correct operation of the Setpoint 1 and Setpoint 2 alarms.
- Institute a formal checking and maintenance plan.
- Operate a Maintenance and Calibration Log and ensure it is updated every time any Maintenance or Calibration work is carried out.

7.3 Service Replacement Sensing Modules

Service replacement Sentro eModules and rModules can be supplied by our Product Support Department on a regular basis. Contact: service@trolex.com for assistance. Simply insert the replacement eModule or rModule into the Sentro 8 and return the original for calibration using the envelope provided.



7.4 Replacing a Sentro Sensing Module

Identify the sensing module to be replaced.

To prevent a Fault condition being generated when the sensing module is removed it is necessary to Exclude the sensing module.

From the Base Screens, use the navigation keypad, scroll to the required sensing module, press and hold down the left arrow on the navigation keypad.

Use the navigation keypad, scroll to Status and select OK.

Select OK to access the Exclude Menu.

Use the navigation keypad, scroll to Yes and select OK.

Use the navigation keypad, scroll to Set or Quit and select OK.

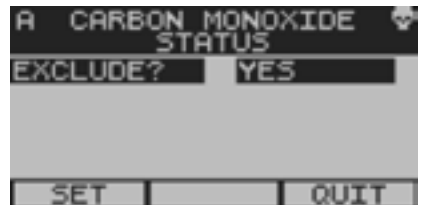
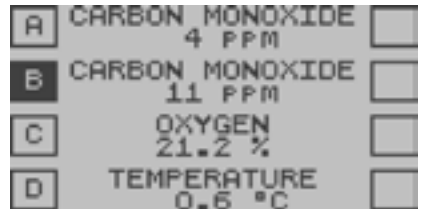



Using a suitable size screwdriver turn the sensing module retainer screw anti-clockwise to release the sensing module.

Remove the sensing module from the module bay.

Insert the replacement sensing module into the module bay ensuring that the connector is fully engaged.

Using a suitable size screwdriver turn the sensing module retainer screw clockwise to secure the sensing module.

Return the removed sensing module to your local Trolex service agent for service or disposal using the envelope provided or suitable packaging if the envelope is not available.

From the Base Screens, use the navigation keypad, scroll to the required sensing module, press and hold down the left arrow on the navigation keypad.

Use the navigation keypad scroll to Status and select OK.

Select OK to access the Exclude Menu.

Use the navigation keypad, scroll to No and select OK.

Use the navigation keypad, scroll to Set or Quit and select OK.

Checkpoint

- Confirmation of eModule or rModule setup data will be requested whenever a eModule or rModule is replaced.
- If an eModule or rModule is replaced by the same type of sensing module, then the existing data would normally be used. Overwrite the data if required or if a different type of eModule or rModule is loaded.
- Ensure that new coding stops are fitted into a replacement eModule or rModule where a user specific code has been previously defined.

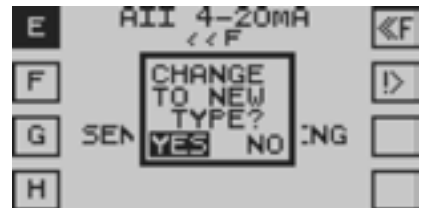
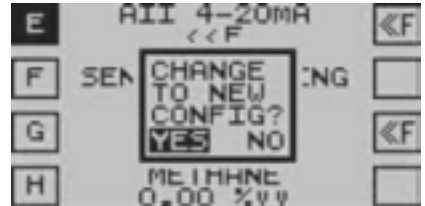

7.6 Record Keeping

Institute a regular calibration and maintenance procedure and keep a record.

Please contact our Product Support Department at service@trolex.com or your local Trolex service agent, for help in installing proper maintenance procedures. The 'Maintenance and Calibration Log' gives an example of a typical record system.

There are also sensing module user accessible locations, via Modbus, which can be used to store recent calibration information.

7.7 Protection Grid

Periodically check the condition of the stainless steel protection grid and sealing ring on the front cover of the instrument. Clean excessive dust accumulations with a small brush or light air steam.



7.8 Servicing and Repair

Some versions are certified to Ex standards and must be serviced and repaired by Trolex Ltd or your local Trolex service agent approved by Trolex Ltd in order to preserve the Ex integrity.

Substitution of components and any additions or changes to the product will invalidate the product warranty and may contravene the terms of the intrinsically safe certificate.

7.9 Disposal

Part of the ethos of Trolex is sustainable design. Sentro 8 contains materials that can be recovered, recycled and reused. At the end of its useful life ensure that the Sentro 8 is recycled in accordance with local laws and bylaws for the geographic area where it is located. The end of its useful life is to be determined by the owner/operator of the equipment and not Trolex. Ensure that the Sentro 8 is recycled by licenced waste contractors with the appropriate licences for handling electronic waste in the geographic area where the Sentro 8 is located.

Checkpoint

Consult your local Trolex service agent or the Trolex Product Support Department if you require assistance with disposal:
service@trolex.com

8. Sentro 8 Battery Back-up

8.1 Introduction

Sentro 8 can be ordered with an optional Battery Back-up. The available options are as follows:

- P9000.223.01 Battery Back-up - General Purpose
- P9000.223.02 Battery Back-up and RS485 Repeater - General Purpose
- P9000.223.03 Battery Back-up and Ethernet Converter - General Purpose

The Sentro 8 will be supplied as a Sensor Station complete with stainless steel hood, battery back-up (options for RS485 Repeater or Ethernet Converter) and audio visual alarm, see photo.

8.2 Battery Back-up

The battery back-up provides power to the Sentro 8 in the event that mains power is lost. The battery back-up is not intended to replace the mains power supply for Sentro 8 but it does enable continued safe working for a limited amount of time in the event of a power supply disruption.

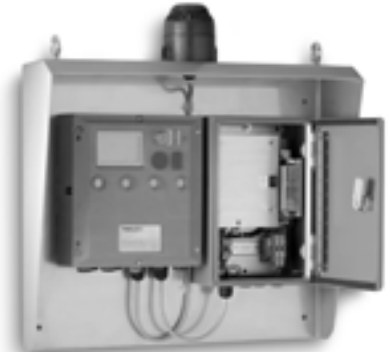

8.3 Battery

The Sentro 8 battery back-up is equipped with a sealed lead acid battery pack mounted in an enclosure with a universal charger. The lead acid battery is rated at 24 V and 2 Ah. The universal charger will accept a supply voltage of 85 to 265 V ac.

Expected Battery Life	
Equipment	Battery life
Sentro 8 with battery back-up	12 hrs
Sentro 8 with battery back-up and RS485 Repeater	10 hrs

8.4 RS485 Repeater (TX2122.56)

An optional RS485 Repeater can be fitted to boost the incoming data signal and increase the transmission distance of the line.

8.5 Ethernet Converter

An optional Ethernet Converter can be fitted. It is a single port RS485 to TCP/IP converter. This enables the RS485 output of the Sentro 8 to be converted to a TCP/IP signal, with an RJ45 connector for ease of connection.

8.6 Battery Back-up Connections

If the Sentro 8 and battery back-up have been purchased as a Sensor Station it will be supplied mounted on a support and wired together. No wiring between the Sentro 8, battery back-up and any accessories will be required.

It will be necessary to wire mains power into the battery charger and data communications into the battery back-up unit. System drawings will be supplied by Trolex and will indicate where power and data communications need to be connected.



8.7 Operation

Operation of the Sentro 8 complete with battery back-up is simple.

8.7.1 Power-up

1. At the start of each shift, open the battery back-up housing. Check the battery switch is in the Off position. If the battery switch is in the On position move it to the Off position.
2. Apply mains power to the Sentro 8 and battery back-up in accordance with local procedures.
3. With power applied move the battery switch to the On position and close the housing.



8.7.2 Power Down

1. At the end of each shift, open the battery back-up housing, move the battery switch to the Off position. Close the housing.
2. Remove mains power to the Sentro 8 and battery back-up in accordance with local procedures.

Checkpoint

The Sentro 8 with a battery back-up must be connected to a live mains power supply in order for the Sentro 8 to power-up. The Sentro 8 and battery back-up are configured to operate in this way and cannot be powered-up from the battery back-up alone. The battery back-up will only power the Sentro 8 in the event of mains power supply failure.

8.8 Maintenance

The battery back-up does require planned preventative maintenance on a regular basis to keep it in the best possible condition, and to ensure that it will work when needed.

8.8.1 Sentro 8 Battery Back-up - Check

Troxex recommends that the Sentro 8 Battery Back-up - Check is carried out every 1 month.

1. Check the Sentro 8 and battery back-up are securely attached. Re-secure as necessary.
2. Check the exterior casing for cracks, penetration, water ingress, signs of being struck, missing parts or other damage.
3. Contact Trolex or your local Trolex service agent to arrange for your Sentro 8 and battery back-up to be repaired:
service@trolex.com
4. After the completion of all maintenance, update the maintenance records.



8.8.2 Battery Back-up Discharge - Test

Troxex recommends that the Battery Back-up Discharge - Test is carried out every 3 months.

1. Power-up the Sentro 8 (see Section 8.7 for details).
2. Remove the mains power supply and start a stopwatch.
3. Measure how long the back-up batteries keep the Sentro 8 powered-up for.



4. Compare the time with the table in Section 8.3.
5. If batteries fail to achieve the required time they should be replaced.
6. Contact Trolex or your local Trolex service agent to arrange for your batteries to be replaced:
service@trolex.com
7. After the completion of all maintenance, update the maintenance records.

8.8.3 Battery Back-up Cells - Replace

Trolex recommends that the Battery Back-up Cells - Replace is carried out every 3 years.

1. Contact Trolex or your local Trolex service agent to arrange for your cells to be replaced:
service@trolex.com
2. After the completion of all maintenance, update the maintenance records.

8.9 Repairs

Should your Sentro 8 and battery back-up become damaged and need repair, contact Trolex or your local Trolex service agent to arrange for your Sentro 8 Battery Back-up to be repaired:
service@trolex.com

After the completion of all maintenance, update the maintenance records.

Disclaimers

The information provided in this document contains general descriptions and technical characteristics of the performance of the product. It is not intended as a substitute for and is not to be used for determining suitability or reliability of this product for specific user applications. It is the duty of any user or installer to perform the appropriate and complete risk analysis, evaluation and testing of the products with respect to the relevant specific application or use. Trolex shall not be responsible or liable for misuse of the information contained herein. If you have any suggestions for improvements or amendments, or find errors in this publication, please notify us at: marketing@trolex.com.

No part of this document may be reproduced in any form or by any means, electronic or mechanical, including photocopying, without express written permission of Trolex.

All pertinent state, regional, and local safety regulations must be observed when installing and using this product. For reasons of safety and to help ensure compliance with documented system data, only Trolex or its affiliates should perform repairs to components.

When devices are used for applications with technical safety requirements, the relevant instructions must be followed.

Trademarks

© 2015 Trolex® Limited.

Trolex is a registered trademark of Trolex Limited. The use of all trademarks in this document is acknowledged.

Document History

Issue 6	1 December 2014	Sixth issue of this document
Issue 7	15 June 2015	Seventh issue of this document
Rev A	20 October 2022	Document number change
Rev B	23 September 2025	General corrections

Contact Details

Trolex Ltd, Newby Road, Hazel Grove, Stockport, Cheshire, SK7 5DY, UK
+44 (0) 161 483 1435 sales@trolex.com

TROLEX«